



SPRAYMASTER® ELEVATOR AGITATOR – 5 GALLON (20 LITER) CONTAINER



BUILT MARCO
TOUGH
MARCO MANUFACTURED

PART NUMBERS AND SCHEMATICS GUIDE

Company Profile

Since 1944, Marco has developed a strong tradition of providing innovative and reliable products and services to the surface preparation and protective coatings industries. We are the world's premier provider of Abrasives, Blasting, Coating, Dust Collectors, Engineered Systems, Rental, Safety, Service, Repair, & Modernization, and Vacuums.

Through innovative designs and a total commitment to quality, Marco manufactures products that increase production rates, create a safer workplace, and reduce maintenance costs. Marco's industry experience, manufacturing capabilities, legendary customer service, product availability, logistics services, and technology leadership is your assurance that we deliver high quality products and services, providing the best value to you, our customer.

The Marco Difference

- **Industry Experience** – With Marco on your team, you have access to expertise which can only come from decades of industry leadership. We have organized our engineering department, production specialists, customer operations, and safety support into a “Center of Competence.” As a Marco customer, you have access to hundreds of years of cumulative experience related to your operations.
- **Manufacturing Excellence** – Marco is a U.S. based, ISO 9001:2008 certified manufacturer of equipment for the Surface Preparation and Protective Coatings industries. Marco's engineers benchmark the industry to ensure that we design and manufacture superior products that set the “Gold Standard” for performance, safety, and quality.
- **Legendary Customer Service** – Marco's legendary customer service team is staffed by friendly, highly-trained individuals who are focused on providing the highest level of product support, order accuracy, and customer satisfaction.
- **Product Availability** – We stock over 10,000 SKU's and have more than 45 shipping locations to serve North American and International markets for all major brands of blasting and coating equipment. As the largest provider of surface preparation and protective coatings equipment in the world, our inventory levels and product availability are unmatched.
- **Logistics Services** – Marco's in-house logistics team is dedicated to moving your shipment anywhere in the world. We move more than 14,000 truckloads every year, allowing you to save on freight costs by leveraging our buying power. Lower your process costs with a single invoice, which includes product and freight.
- **Technology Leadership** – Our website provides: Operator's Manuals, Part Numbers and Schematics Guides, SDS information, and Features & Specifications Guides, providing access to information 24/7. Our Extranet application allows you to receive quotes and place orders online. Our Intranet maintains a complete record of your purchase history to assist with ongoing support of your existing equipment and future purchasing decisions.

Vision Statement

Marco is the world's premier provider of Abrasives, Blasting, Coating, Dust Collectors, Engineered Systems, Rental, Safety, Service, Repair, & Modernization, and Vacuums.

Mission Statement

Marco provides strong leadership and innovation to the surface preparation and protective coatings industries. We dedicate our efforts to the continuous improvement of our products, services, processes, people, and most importantly, the quality of our customer's experience.

Quality Statement

Marco is committed to providing superior quality in the design, manufacturing, distribution, rental, service, and repair of our products. Our ISO 9001:2008 certification extends throughout all operations in all locations. Continuous improvement of our processes and supply chain Integration comprise the core of our business strategy for delivering exceptional quality and value in all Marco products and services.

Management Philosophy

We are a company dedicated to the success of every customer and associate. We discuss, debate, challenge, measure, and test our ideas. We will be boundless and limitless in our passion to improve. Through sound leadership and dedicated associates, we will ensure a long term, profitable future for Marco, our associates, customers, and suppliers.

TABLE OF CONTENTS

Part Numbers	4
Part Numbers And Schematics Guide	6
Spraymaster® Elevator Agitator – 5 Gallon (20 Liter) Container	6
Filter/Lubricator Assembly	8
Optional Accessories	9

PART NUMBERS

SPRAYMASTER® ELEVATOR AGITATOR – 5 GALLON (20 LITER) CONTAINER

Part Numbers	Air Motor Power	15:1 Mixer Gear Drive	Filter/Lubricator	5 Gallon Mixer Blade	Air Cylinder	Frame
20100998	1.25 HP	X	X	X	3-1/4" x 20" Double Acting Piston	Steel

PART NUMBERS



PART NUMBERS AND SCHEMATICS GUIDE

Spraymaster® Elevator Agitator – 5 Gallon (20 Liter) Container

Item #	Part #	Description	Item #	Part #	Description
Fig. 1					
—	20100998	Spraymaster® Elevator Agitator – 5 Gallon (20 Liter) Container	28	20101236	10-32 Locknut <i>(Four Required)</i>
1	20100827	15:1 Mixer Gear Drive	29	20101009	Bucket Clamp
2	20101193	3/8" NPT Needle Valve	30	20101023	Draw Pull Latch
3	20100843	1" To 1" Shaft Coupling	31	20101101	2" Stainless Steel Hinge
4	20101264	Screw	—	1091130	Hazard Identification Label
5	20101019	5 Gallon Mixer Blade	—	1091135	Hazard Identification Label
6	1006067	10" Wheel	—	1091017	Hazard Identification Tag
7	1006211	Wheel Clip	—	209V515	Operator's Manual – AM Series Lubricated Air Motors
8	20101046	Cylinder 3-1/4" x 20" Double Acting Piston	—	205M071	Features & Specifications Guide – Spraymaster® Elevator Agitator – 5 Gallon (20 Liter) Container
9	10AH038	Air Hose 3/8"	—	206M071	Part Numbers & Schematics Guide – Spraymaster® Elevator Agitator – 5 Gallon (20 Liter) Container
10	2080020	3/8" Air Fluid Hose Fitting <i>(Two Required)</i>	—	10901071	Operator's Manual – Spraymaster® Elevator Agitator – 5 Gallon (20 Liter) Container
11	20101044	4-Way 1/4 NPT Rotary Valve			
12	10104603	1/2-13 x 1-1/4" Bolt – Grade 5 – Zinc <i>(Four Required)</i>			
13	20101194	1/4" NPT Speed Control Muffler			
14	20100540	Jam Nut 3/4-16 UNF			
15	10100596	3/4" Lock Washer			
16	20100148	1" I.D. x 1-1/2" O.D. 10 Gage Washer			
17	20PFBA31095614	1/4" Tube x 1/4" NPT 90° Fitting			
18	20SUTR10805CLT500	1/4" Clear Tubing			
19	20PFBA31755614	1/4" Tube x 1/4" NPT Straight Fitting			
20	20PFHA24SA0604	1/4" x 3/8" Hex Nipple			
21	20BK350401	Air Motor Muffler Assembly			
22	20100661	5/16-18 x 1-3/4" Grade 8 Hex Bolt			
23	10L805003	5/16" Flat Washer – Zinc			
24	20100900	5/16-18 Nylon Locknut			
25	10100675	1/2" Lock Washer <i>(Four Required)</i>			
26	20PFHA24SB0804	1/2" M x 1/4" (F) Bushing			
27	20101235	10-32 x 1-3/4" SHCS <i>(Four Required)</i>			

PART NUMBERS AND SCHEMATICS GUIDE

Figure 1: Spraymaster® Elevator Agitator – 5 Gallon (20 Liter) Container

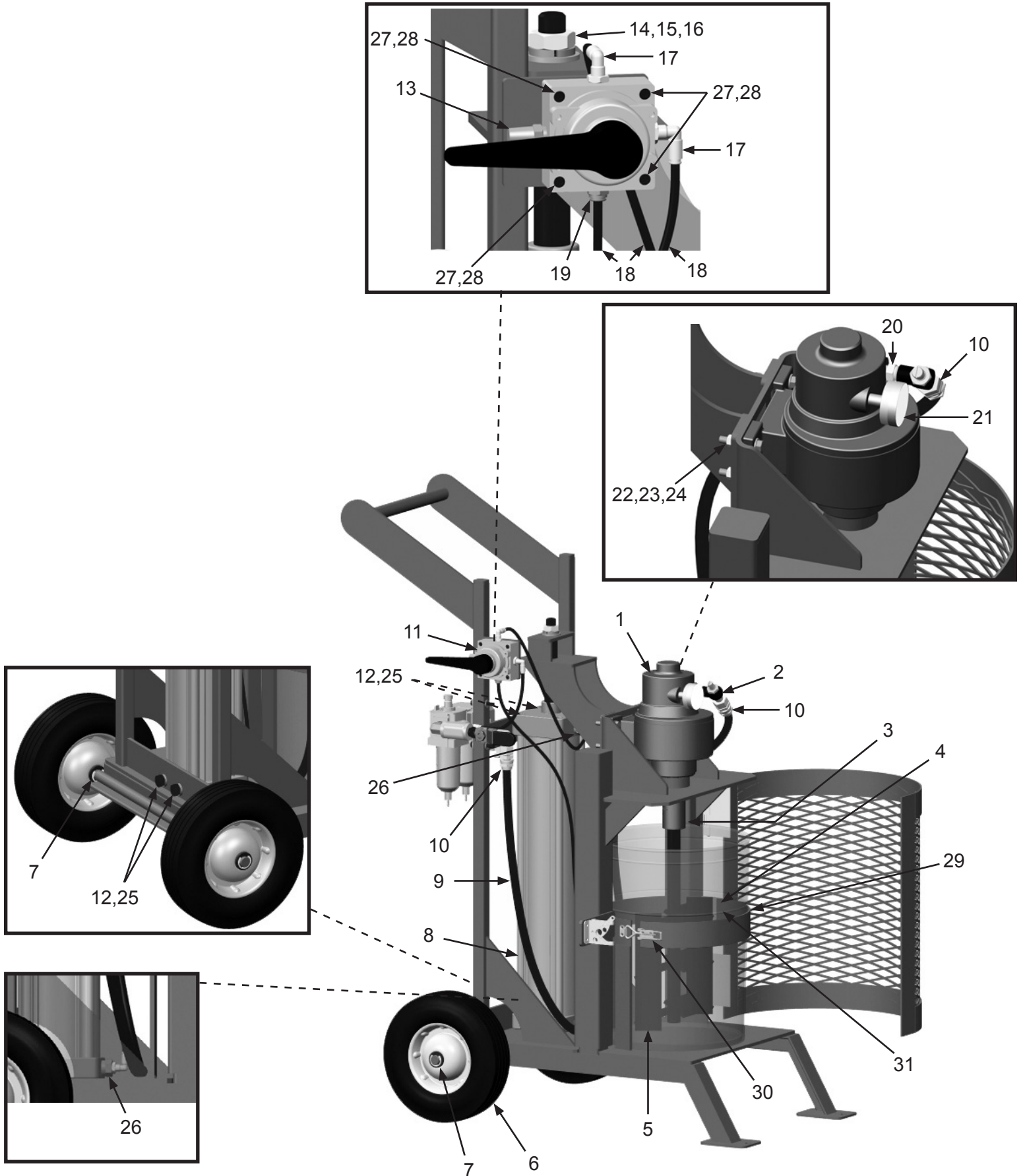

PART NUMBERS AND SCHEMATICS GUIDE

Figure 2: Filter/Lubricator Assembly

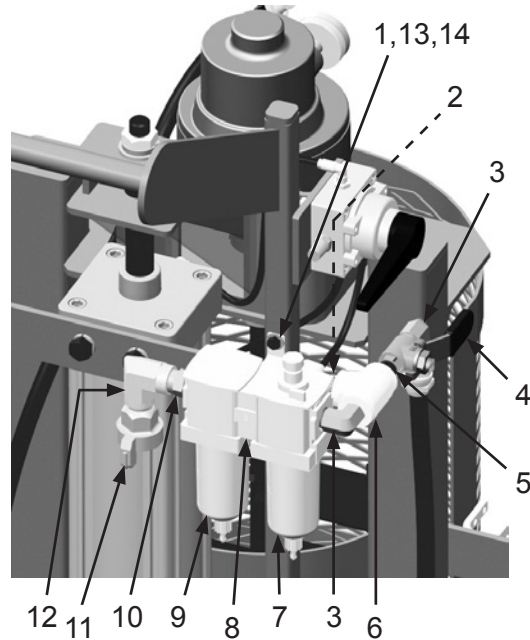



Item #	Part #	Description
Fig. 2		
1	1019044	1/4-20 x 1-3/4" Zinc Bolt (<i>Two Required</i>)
2	20PFHA24SB0604	3/8" x 1/4" Reducing Bushing
3	20PFHA25UA0606	3/8" Male 90° Elbow (<i>Two Required</i>)
4	1080060	3/8" NPT Full Port Brass Ball Valve
5	20PFHA24SA0606	3/8" Hex Nipple
6	20PFHA25VJ06	3/8" Female Tee
7	20101191	3/8" NPT Lubricator
8	20101192	Lubricator & Filter Spacer
9	20101190	3/8" NPT 25 Micron Filter
10	20PFHA24SA0806	3/8" x 1/2" Hex Nipple
11	10ME122	1/2" NPT Male 2 Lug Coupling
12	20PFHA25UJ08	1/2" Female Elbow
13	1012323	1/4-20 Zinc Lock Nut with Nylon Insert (<i>Two Required</i>)
14	1014017	1/4" Flat Washer (<i>Two Required</i>)
—	20101278	25 Micron Filter Element
—	20101279	Semi-Auto Drain Replacement Bowl
—	20101280	Oil Drip Dome
—	10105291	Air Tool Oil – 4 oz.
—	1070517	Marvel Pneumatic Tool Oil – 32 oz.

OPTIONAL ACCESSORIES

		3/4" I.D. X 1-1/4" O.D. AIR HOSE				
	Part Numbers	Working Pressure	Hose Cover Color	Length	Hose I.D.	Hose O.D.
	10AH034	200 PSI	Red	Per Ft.	3/4"	1-1/4"

		3/4" I.D. X 1-1/4" O.D. AIR HOSE WITH COUPLINGS INSTALLED					
	Part Numbers	Working Pressure	Hose Cover Color	Length	Hose I.D.	Hose O.D.	Couplings
	10AH034AC	200 PSI	Red	50 Ft.	3/4"	1-1/4"	2-Lug Crimped On

		MALE HOSE END COUPLING AND GASKET FOR 3/4" I.D. AIR HOSE					
	Part Numbers	Hose I.D.	Material	Coupling Style	GASKET		
					Rubber Gasket	Gasket I.D.	Gasket O.D.
	10HE1	3/4"	Plated Iron	2-Lug	10UG2	3/4"	1-3/8"

		BOSS® CLAMP FOR 3/4" I.D. AIR HOSE		
	Part Numbers	Hose I.D.	Hose O.D. Range	Material
	10A9	3/4"	1-8/64" – 1-20/64"	Plated Steel

OPTIONAL ACCESSORIES

		1" I.D. X 1-1/2" O.D. AIR HOSE				
Part Numbers		Hose Cover Color	Working Pressure	Length	Hose I.D.	Hose O.D.
	10AH100B	Black	200 PSI	Per Ft.	1"	1-1/2"
	10AH100	Red	200 PSI	Per Ft.	1"	1-1/2"

		1" I.D. X 1-1/2" O.D. AIR HOSE WITH COUPLINGS INSTALLED					
Part Numbers		Working Pressure	Hose Cover Color	Length	Hose I.D.	Hose O.D.	Couplings
	10AH100AC	200 PSI	Red	50 Ft.	1"	1-1/2"	2-Lug Crimped On

		MALE HOSE END COUPLING AND GASKET FOR 1" I.D. AIR HOSE					
Part Numbers		Hose I.D.	Material	Coupling Style	GASKET		
					Rubber Gasket	Gasket I.D.	Gasket O.D.
	10HE2	1"	Plated Iron	2-Lug	10UG2	3/4"	1-3/8"

		HAMMER-LOCK GROUND JOINT FITTING FOR 1" I.D. AIR HOSE	
Part Numbers		Hose I.D.	Material
	10DXGF36	1"	Plated Steel

		BOSS® CLAMP FOR 1" I.D. AIR HOSE		
Part Numbers		Hose I.D.	Hose O.D. Range	Material
	10A14	1"	1-32/64" – 1-52/64"	Plated Steel

GLOBAL HEADQUARTERS

- 3425 East Locust Street
Davenport, IA 52803

ph: 800.BLAST.IT (800.252.7848)
ph: 563.324.2519
fax: 563.324.6258

REGIONAL BRANCH OFFICES

- **Iowa**
Davenport
- **Louisiana**
Gonzales
Harvey
Lafayette
- **Ohio**
Youngstown
- **Texas**
Beaumont
Corpus Christi
Deer Park



ABRASIVES

BLASTING

COATING

DUST COLLECTORS

ENGINEERED SYSTEMS

RENTAL

SAFETY

SERVICE, REPAIR, & MODERNIZATION

VACUUMS

40+ NATIONWIDE SHIPPING LOCATIONS



★ Marco Regional Branch Offices and Shipping Locations ● Direct Shipping Locations

CONTACT MARCO

800.BLAST.IT
(800.252.7848)
563.324.2519
FAX: 563.324.6258

WWW.MARCO.US
SALES@MARCO.US