

rpb[®] NOVA 2000[®]

National Institute for
Occupational Safety and Health
NIOSH[®]

INSTRUCTION MANUAL



Employers: Read this manual and the flow control device Instruction Manual and carry out the Employer Responsibilities (page 8).

Product users: Read this manual and the flow control device Instruction Manual and follow the Product User Safety Instructions (page 10).

Make sure this manual is available to all users for reference.

Español: <http://www.rpbsafety.com/product/nova-2000/>

**PROTECTING YOU FOR
LIFE'S BEST MOMENTS[®]**

rpb[®]

CONTENTS

■ EXPLANATION OF SIGNAL WORDS AND SYMBOLS	2
■ INTRODUCTION	3
■ IMPORTANT SAFETY INFORMATION	
□ PROTECTION PROVIDED AND LIMITATIONS	4
□ RESPIRATORY COMPONENT DIAGRAM - NIOSH CAUTIONS & LIMITATIONS	6
□ AIR SOURCE, FITTINGS, AND PRESSURE	7
□ EMPLOYER RESPONSIBILITIES	8
□ PRODUCT USER SAFETY INSTRUCTIONS	10
□ BREATHING AIR PRESSURE TABLE	13
■ RESPIRATOR SETUP AND CARE	15
■ DONNING AND DOFFING	17
■ INSPECTION AND CLEANING	19
■ PARTS AND ACCESSORIES	20
■ WARRANTY AND LIABILITY STATEMENT	24

EXPLANATION OF SIGNAL WORDS AND SYMBOLS

The following signal word and safety symbols are used in this manual and product labeling:

 **WARNING** **WARNING** indicates a hazardous situation that, if not avoided, could result in death or serious injury.

 **DANGER** **DANGER** Indicates a hazardous situation that, if not avoided, will result in death or serious injury.



Read the Instruction Manual.

Additional copies of RPB[®] manuals can be found at www.rpbsafety.com.

RPB[®] Safety LLC is an ISO9001 certified company.

INTRODUCTION

The NOVA 2000® is a fully padded heavy industry respirator designed for abrasive blasting and other industrial applications. Additionally, the NOVA TALK™ in-helmet communication system allows for hands free radio communication. The NOVA 2000® can increase productivity with the advanced tear-off lens system and other innovative features. The NOVA 2000® is a NIOSH approved Type CE Supplied Air Respirator.

This product must be inspected and maintained in accordance with this instruction manual at all times.

See PROTECTION PROVIDED AND LIMITATIONS (page 4) for details.

RPB® SAFETY - GLOBAL HEADQUARTERS

2807 Samoset Rd, Royal Oak, MI 48073, USA.

T: +1-866-494-4599 F: +1-866-494-4509 E: sales.us@rpb-safety.com **rpb-safety.com**

RPB® SAFETY - APAC

1 Ivan Jamieson Place, Christchurch Airport, Christchurch 8053 New Zealand.

T: +64-3-357-1761 F: +64-3-357-1763 E: sales.nz@rpb-safety.com **rpb-safety.com**

RPB® SAFETY - EMEA

Unit 2, Teardrop Industrial Park, London Road, Swanley, BR8 8TS, United Kingdom

T: +44-800-689-5031 E: sales@rpb-safety.co.uk **rpb-safety.com**

Copyright ©2018 RPB Safety, LLC. All rights reserved. All materials contained on this website are protected by United States copyright law and may not be reproduced, distributed, transmitted, displayed, published or broadcast without the prior written permission of RPB Safety, LLC. You may not alter or remove any trademark, copyright or other notice from copies of the content.

All trademarks, service marks, and logos used in this publication, both registered and unregistered, are the trademarks, service marks, or logos of their respective owners. The green and gray color combination is a registered trademark of RPB Safety, LLC. All rights in the RPB Intellectual Property contained in this publication, including copyright, trademarks, service marks, trade secret, and patent rights are reserved. RPB Intellectual Property means any patent, patented articles, patent applications, designs, industrial designs, copyrights, software, source code, database rights, moral rights, inventions, techniques, technical data, trade secrets, know-how, brands, trademarks, trade names, slogans, logos, and any other common law and proprietary rights, whether registered or unregistered anywhere in the world, that are owned by, developed in whole or in part by, or licensed by RPB Safety, LLC.

For technical assistance contact our Customer Service Department at 1-866-494-4599 or email: customerservice@rpb-safety.com

Form #: 36

Rev: 9

IMPORTANT SAFETY INFORMATION

⚠ WARNING Improper selection, fit, use, or maintenance of this product can result in injury; life threatening delayed lung, skin or eye disease; or death.

This product is intended for occupational use in accordance with applicable standards or regulations for your location, industry, and activity (see Employer Responsibilities, page 8). Familiarity with standards and regulations related to the use of this protective equipment is recommended, even if they do not directly apply to you. If self-employed or if used in a non-occupational setting, refer to Employer Responsibilities and Product User Safety Instructions. Go to rpb.com/safety for helpful links to OSHA and other content.

Employers: Read this manual and the air supply device Instruction Manual and carry out the Employer Responsibilities (page 8).

Product users: Read this manual and the air supply device Instruction Manual and follow the Product User Safety Instructions (page 10).

PROTECTION PROVIDED AND LIMITATIONS

RESPIRATION

The RPB[®] NOVA 2000[®] is approved by NIOSH in the category as follows:

Supplied Air

The RPB[®] NOVA 2000[®] respirator, when properly fitted and used with all required components, including the Breathing Tube Assembly, Flow Control Device, and RPB[®] Breathing Air Line is a NIOSH approved Type CE respirator with an assigned protection factor of 1000. As such, it significantly reduces, but does not completely eliminate, the breathing of contaminants by the respirator wearer. Use with an airline filter, such as the O4-900 RPB[®] RADEX[®] Airline Filter. Specific protection depends on the setup of the airline filter (see the RPB[®] RADEX[®] Instruction Manual). The approved Flow Control Devices for this respirator are: NV2016 Flow Control Valve, 4000-01 Cold Air Tube, 4000-20 Hot Air Tube, or the O3-500 C40™ Climate Control Device, or the O3-106 Low Pressure Constant Flow Valve.

HAZARD LIMITATIONS

The RPB[®] NOVA 2000[®] Respirator is **NOT FOR USE** if:

- In atmospheres immediately dangerous to life or health (IDLH).
- Wearer cannot escape without the aid of the respirator.
- Atmosphere contains less than 19.5% oxygen.
- For protection against hazardous gases (e.g., carbon monoxide).
- Contaminants are in excess of regulations or recommendations.
- Contaminants or contaminant concentrations are unknown.
- Work area is poorly ventilated.
- The temperature is outside the range of 14°F to 140°F (-10°C to +60°C).

- A flammable or explosive atmosphere is present when used with systems including electrical parts that are not intrinsically safe, such as O9-900 NOVA TALK™.

FACE AND EYES:

- The NOVA 2000® respirator with Inner Lens meets ANSI/ISEA Z87.1 requirements and designed for abrasive blasting, grinding, and other industrial applications.
- The NOVA 2000® is not designed or tested to provide protection against molten metals or corrosive liquids.
- **Note:** Safety glasses may be required to be worn depending on the job hazard analysis. The NOVA 2000® does not protect against the potential transfer of impact to glasses worn underneath the Visor. It does not provide complete eye and face protection against severe impact and penetration and is not a substitute for good safety practices and engineering controls.

HEAD:

- The NOVA 2000® meets the ANSI/ISEA Z89.1 Type 1C requirements for physical head protection as a hard hat. The helmet is design to provide limited head protection by reducing the force of falling objects striking the top of the head. Ensure the helmet is adjusted to properly fit the user by adjusting the head harness and side pads.

HEARING:

- Hearing protection must be worn and properly fitted when exposed to noise levels that exceed the OSHA permissible exposure levels.

PLACE NIOSH APPROVAL LABEL HERE.

rpb[®] NOVA 2000[®]

RESPIRATOR COMPONENT CONCEPT

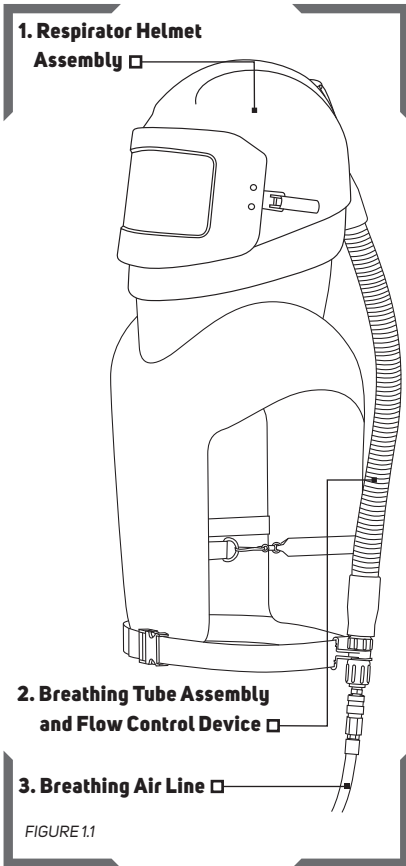

NIOSH - CAUTIONS AND LIMITATIONS

- A Not for use in atmospheres containing less than 19.5 percent oxygen.
- B Not for use in atmospheres immediately dangerous to life or health.
- C Do not exceed maximum use concentrations established by regulatory standards
- D Air-line respirators can be used only when the respirators are supplied with respirable air meeting the requirements of CGA G-7.1 Grade D or higher quality.
- E Use only the pressure ranges and hose lengths specified in the user's instructions
- J Failure to properly use and maintain this product could result in injury or death.
- M All approved respirators shall be selected, fitted, used and maintained in accordance with MSHA, OSHA, and other applicable regulations.
- N Never substitute, modify, add or omit parts. use only exact replacement parts in the configuration as specified by the manufacturer.
- O Refer to user's instructions, and/or maintenance manuals for information on use and maintenance of these respirators.
- S Special or critical user's instructions and/or specific limitations apply. Refer to user's Instruction pages 13-14 (Breathing Air Pressure Table) before donning.

AIR SOURCE, FITTINGS, AND PRESSURE

AIR SOURCE

Supplied Air

Locate the air source in a clean air environment, always use a filter on the inlet of your air source. Make sure the air source is somewhere that vehicles, forklifts, and other machinery are not running near the air inlet, as this will cause carbon monoxide to be drawn into your air supply. Always use suitable after coolers/dryers with filters and carbon monoxide alarms to ensure clean breathable air is supplied at all times. A Radex® Airline Filter (04-900) and a GX4® Gas Monitor (08-400) are recommended. The air should be regularly sampled to ensure that it meets Grade D requirements.

AIR QUALITY

This respirator must be supplied with clean breathable air at all times. Breathable air must at least meet the requirements for Type 1 gaseous air described in the Compressed Gas Association Commodity Specifications G-7.1 (Grade D or higher) and as specified by Federal Law 42 CFR 84, subpart J.84.141(b) and 29 CFR 1910.134 (i) the RPB® NOVA 2000® does not purify air or filter contaminants. A carbon monoxide monitor must be used at all times.



DANGER

Do not connect the respirator's air supply hose to nitrogen, toxic gases, inert gases or other non-breathable air sources. Check the air source before using the respirator. This apparatus is not designed for use with mobile air supply systems i.e. cylinders. Connecting the supply hose to a non-breathable air source will result in serious injury or death.

BREATHING AIR SUPPLY HOSES AND FITTINGS

RPB® breathing air supply hoses and fittings must be used between the point of attachment and the respirator breathing air connection at the wearer's belt. The hose sections must be within the correct length and the amount of sections must be within the number specified in the breathing air pressure table on pages 13-14.

BREATHING AIR PRESSURE

The air pressure must be continually monitored at the point of attachment. Air pressure must be read from a reliable pressure gauge whilst the respirator has air flowing through it.

EMPLOYER RESPONSIBILITIES

Your specific responsibilities may vary by location and industry, but in general RPB® expects that employers will:

■ **Follow all applicable standards and regulations for your location, industry, and activity.**

Depending on your location and industry, a number of standards and regulations may apply to your selection and use of respirators and other personal protective equipment. These may include such things as federal (e.g., OSHA, MSHA, Canadian Occupational Health and Safety), local (e.g., state, provincial), or military standards and regulations and consensus standards such as ANSI and CSA. There are also requirements specific to particular contaminants, e.g. silica (see rpb-safety.com/important-safety-information/ for more information), asbestos, organic pathogens, etc. Know which requirements apply to your location and industry.

■ **Have appropriate safety programs in place.**

Have and follow:

- A workplace safety program.
- A written respiratory protection program in accordance with applicable standards and regulations (e.g., OSHA 29 CFR 1910.134; ANSI/ASSE Z88.2; CSA Z94.4, etc.).

■ **In accordance with the above,**

- **Perform a hazard analysis and select appropriate equipment for each activity.** A hazard analysis should be performed by a qualified person. Controls should be in place as appropriate and a qualified person should determine what kind of respiratory, face and eye, head, and hearing protection is appropriate for the intended activities and environments of use. (For example, select a respirator appropriate to the specific airborne hazards, with consideration of workplace and user factors and with an Assigned Protection Factor (APF) that meets or exceeds the required level for employee protection, select welding face and eye protection appropriate to the type of welding to be done, etc.)

As applicable, check your workplace safety program, respiratory protection program, and standards and regulations for your activity or industry for related protection requirements, and see this manual (Protection Provided and Limitations, page 4) and the flow control device Instruction Manual for product specifications.

- **Be sure employees are medically qualified to use a respirator.**

Have a qualified physician or other licensed health care professional (PLHCP) perform medical evaluations using a medical questionnaire or an initial medical examination per OSHA 29 CFR 1910.134.

- **Train employees in the NOVA 2000®'s use, maintenance, and limitations.**

Appoint a qualified individual who is knowledgeable about the RPB® NOVA 2000® per ANSI/ASSE Z88.2 guidelines to provide training:

Section 8.1 Qualifications of the Respirator Trainer. Anyone providing respirator training shall:

- a) be knowledgeable in the application and use of the respirator(s);
- b) have practical knowledge in the selection and use of respirator(s) and work practices at the site;

- c) have an understanding of the site's respirator program; and
- d) be knowledgeable of applicable regulations.

Train each NOVA 2000® user in the product's use, application, inspection, maintenance, storage, fitting, and limitations in accordance with the content of this Instruction Manual and the approved flow control device instruction manual and standard or regulatory requirements. Ensure that each intended user reads both these manuals.

■ **Ensure that equipment is properly set up, used, and maintained.**

Make sure that equipment is properly set up, inspected, fitted, used, and maintained, including selection of the appropriate air filter cartridge and, when applicable, welding filter shade adjustments, for the application.

■ **Measure and monitor airborne contaminants in the work area.**

Measure and monitor airborne contaminant levels in the work area in accordance with applicable requirements. Make sure work area is well ventilated.

■ **Ensure abrasive is used that is suitable for abrasive blasting.**

Check the material safety data sheets for manufacturers warnings and recommendations and verify the blasting media conforms with applicable standards/regulations (e.g. regarding respirable silica). Refer to rpbsafety.com/importantsafetyinformation/ for links to websites that can provide regulatory guidance.

■ **If you have any questions, contact RPB®.**

■ Call Customer Service Department:

Tel: 1-866-494-4599

Email: customerservice@rpbsafety.com

Web: rpbsafety.com

PRODUCT USER SAFETY INSTRUCTIONS

BEFORE INITIAL USE - BE TRAINED AND MEDICALLY QUALIFIED

Do not use this respirator until you have read this manual and the flow control device Instruction Manual (additional copies available at www.rpbsafety.com/resources/) and been trained in the respirator's use, maintenance, and limitations by a qualified individual (appointed by your employer) who is knowledgeable about the RPB® NOVA 2000® respirator.

Do not wear this respirator until you have passed a medical evaluation using a medical questionnaire or an initial medical examination by a qualified physician or other licensed health care professional (PLHCP).

Allergens: No known common allergens are used in this product.

Some materials could cause an allergic reaction in susceptible individuals. If you have a known allergy or develop irritation, inform your employer. Irritation may occur from lack of cleaning. Following all cleaning and care instructions provided in the instruction manuals for this and any other RPB® products you are using.

MAKE SURE THE SYSTEM IS READY FOR USE

Make sure you have a complete system. Verify that you have all required components for the NOVA 2000® to serve as a complete NIOSH approved respirator:

- Respirator Helmet Assembly (NOVA 2000®)
- Breathing Tube Assembly
- Flow Control Device (Flow Control Valve, Cold Air Tube, Hot Air Tube, C40™ Climate Control Device, or Low Pressure Constant Flow Valve)
- Breathing Air Line

See *Respirator Component Diagram* (page 6). The RPB® NOVA 2000® is only approved to be used with the RPB® Flow Control Valve, RPB® Cold Air Tube, RPB® Hot Air Tube, or RPB® C40™ Climate Control Device, and RPB® Low Pressure Constant Flow Valve. Use only authentic RPB® brand parts and components that are part of the NIOSH approved respirator assembly. Using incomplete or inappropriate equipment, including the use of counterfeit or non-RPB® parts, can result in inadequate protection and will void the NIOSH approval of the entire respirator. Do not modify or alter any part of this product.

Inspect all components daily for signs of damage or wear and tear that may reduce the level of protection originally provided. Remove any damaged component or product, including any helmet or visor that has been subject to impact, from service until repaired or replaced. Scratched or damaged safety lenses or other components should be replaced with genuine RPB® brand replacement parts. When safety and impact lenses are replaced, make sure to remove any additional protective film from both sides of the lens. If the film is left in place, it could affect the optical clarity of the lens and cause eye strain. Inspect the inside of the respirator for respirable dust or other foreign objects. Keep the inside of the respirator clean at all times.

Make sure that the helmet is correctly assembled in the configuration that suits your application. Never use the respirator without all lenses in place. This includes the Inner and Outer Lenses. These

lenses, when installed properly, are part of the respiratory seal to prevent toxic or hazardous gases, liquids or dust from entering the helmet. An incomplete or improperly installed lens system could provide inadequate impact and respiratory protection. *See Respirator Setup and Care (page 15). See Donning (page 17) for fit information.*

VERIFY THAT YOU HAVE THE APPROPRIATE EQUIPMENT FOR YOUR ACTIVITY

Verify that the NOVA 2000® provides appropriate protection for your activity. As applicable, check your workplace safety program, respiratory protection program, and standards and regulations for your activity or industry. (See PROTECTION PROVIDED AND LIMITATIONS, page 4.)

BEFORE DONNING THE NOVA 2000®:

Verify airborne contaminants are within recommended limits for respirator use:

- Determine the type and level of contamination. Verify that airborne contaminant concentrations do not exceed those allowed by applicable OSHA, EPA, or NIOSH regulations and recommendations for powered air purifying respirators or supplied air respirators.

Filtering the breathing air:

- **Supplied Air Respirator:** Once the contamination levels have been confirmed, check to make sure the airline filter is working correctly. Follow the Radex® Airline Filter Instruction Manual.

Make sure the area is ventilated and monitored:

- Make sure that the area is well ventilated and that regular air samples are taken to confirm the atmosphere stays within the levels recommended by OSHA and other governing bodies. For Supplied Air, it is recommended to use a GX4® Gas Monitor. Follow the GX4® Gas Monitor Instruction Manual.

If you have any questions, ask your employer.

DO NOT ENTER THE WORK AREA if any of the following conditions exist:

- Atmosphere is immediately dangerous to life or health.
- You cannot escape without the aid of the respirator.
- Atmosphere contains less than 19.5% oxygen.
- A flammable or explosive atmosphere is present when used with systems including electrical parts that are not intrinsically safe, such as O9-900 NOVA TALK™.
- Contaminants are in excess of regulations or recommendations.
- Contaminants or contaminant concentrations are unknown.
- Work area is poorly ventilated.
- The work area is a confined space (unless proper measures are taken for confined spaces).
- The temperature is outside the range of 14°F to 140°F (-10°C to +60°C).

PRODUCT USER SAFETY INSTRUCTIONS CONTINUED

LEAVE THE WORK AREA IMMEDIATELY IF:

- Any product component becomes damaged.
- Vision is impaired.
- Airflow stops or slows down.
- Breathing becomes difficult.
- You become dizzy, nauseous, too hot, too cold, or ill.
- Your eyes, nose, or skin become irritated.
- You taste, smell, or see contaminants inside the helmet.
- You have any other reason to suspect that the respirator is not providing adequate protection.

PRODUCT CARE

Never place the helmet on hot surfaces. Do not apply paints, solvents, adhesives or self-adhesive labels except as instructed by RPB®. This product may be adversely affected by certain chemicals.

Clean and disinfect with mild detergent and a soft cloth or a disinfectant wipe. See the "Respirator Setup and Use" section for more specific cleaning instructions.

INSTRUCTIONS FOR SPECIFIC USES OR ENVIRONMENTS

Confined Spaces

If this respirator is used in confined spaces, ensure the area is well ventilated and that all contaminant concentrations are below those recommended for this respirator. Follow all procedures for confined space entry, operation, and exit as defined in applicable regulations and standards.

Abrasive Blasting

Do not use hazardous abrasives (e.g. those that violate applicable standards/regulations, such as abrasives containing more than trace amounts of silica, lead, arsenic, etc.) - these could result in serious injury or death. Consult your abrasive supplier and read the material safety data sheets for the abrasives to be used to determine suitability for blasting applications.

BREATHING AIR PRESSURE TABLE

S - SPECIAL OR CRITICAL USERS INSTRUCTIONS - SAR TABLE 1.1

This table lists Air pressure ranges needed to provide the RPB® NOVA 2000® with the volume of air that falls within the required range of 6 -15 cfm or 170 - 425 lts/min according to U.S. government regulations.

1. AIR SOURCE	2. AIR SUPPLY HOSE	3. NV2021 BREATHING TUBE ASSEMBLY AND FLOW CONTROL DEVICES	4. SUPPLY HOSE LENGTH (FT)	5. MAX NUMBER OF SECTIONS	6. PRESSURE RANGE (PSIG AIR)
Portable or Stationary Compressor	NV2028 (25ft) NV2029 (50ft) NV2027 (100ft) 04-352-25-RZ (25ft) 04-352-50-RZ (50ft) 04-352-100-RZ (100ft)	NV2016 Flow Control Valve Assembly	25	1	28 - 30
			50	1	28 - 30
			100	2	30 - 33
			150	3	33 - 36
			200	4	36 - 38
			250	5	38 - 39
		300	6	39 - 43	
		4000-01 Cold Air Tube Assembly	25	1	55 - 56
			50	1	56 - 57
			100	2	60 - 62
			150	3	65 - 67
			200	4	70 - 72
250	5		77 - 78		
300	6	80 - 82			
4000-20 Hot Air Tube Assembly	25	1	67 - 68		
	50	1	69 - 70		
	100	2	73 - 74		
	150	3	77 - 78		
	200	4	81 - 82		
	250	5	86 - 87		
300	6	91 - 92			
03-500 C40 Climate Control Assembly	25	1	50 - 80		
	50	1	55 - 85		
	100	2	60 - 95		
	150	3	65 - 95		
	200	4	70 - 100		
	250	5	75 - 100		
300	6	85 - 100			
Low Pressure Compressor or Air Pump	NV2035 (50ft) NV2036 (100ft)	03-106 Low Pressure Constant Flow Valve Assembly	50	1	7-8
			100	1	8-9
			150	2	10-11
			200	2	11-12
			250	3	12-13
			300	3	14-15

CONTINUED ON NEXT PAGE.

⚠ WARNING If the Breathing Air Lines and Flow Control Device have RZ™ fittings, they will only attach to other RZ™ fittings. They will not work with Universal Couplers. Do not modify air line fittings. RZ™ fittings prevent connection to unsafe air sources.

BREATHING AIR PRESSURE TABLE CONTINUED

1. AIR SOURCE	2. AIR SUPPLY HOSE	3. NV2021 BREATHING TUBE ASSEMBLY AND FLOW CONTROL DEVICES	4. SUPPLY HOSE LENGTH (FT)	5. MAX NUMBER OF SECTIONS	6. PRESSURE RANGE (PSIG AIR)
Portable or Stationary Compressor	04-342-25 (25ft) 04-342-50 (50ft) 04-342-100 (100ft)	NV2016 Flow Control Valve Assembly with Schrader fitting	25	1	28-30
			50	1	30-32
			100	2	33-35
			150	3	36-38
			200	4	40-42
			250	5	44-46
		300	6	48-50	
		4000-01 Cold Air Tube Assembly with Schrader fitting	25	1	60-65
			50	1	60-65
			100	2	65-70
			150	3	70-75
			200	4	75-80
			250	5	80-85
		300	6	85-90	
		4000-20 Hot Air Tube Assembly with Schrader fitting	25	1	70-75
			50	1	70-75
			100	2	75-80
			150	3	80-85
			200	4	85-90
			250	5	90-95
		300	6	95-100	
		03-500 C40 Climate Control Assembly with Schrader fitting	25	1	60-80
			50	1	65-85
			100	2	70-95
150	3		75-95		
200	4		80-100		
250	5		85-100		
300	6	95-100			

⚠ WARNING Make sure you understand the Breathing Air Pressure table before using this respirator.

1. Use the correct air source. Do not use an ambient air pump, as it does not supply enough pressure (column 1).
2. Confirm the part number of the air supply hose you are using (column 2) and the flow control device (column 3) you are using..
3. Check your RPB® Safety Air Supply Hose is within the correct length (column 4) and the correct number of hose sections (column 5).
4. Set the air pressure at the point of attachment within the range specified (column 6).

Make sure air is flowing through your respirator when setting the air pressure.

Failure to supply the minimum required air pressure at the point of attachment for the length of air supply hose will decrease the level of protection provided. In addition, could result in contaminants being inhaled as the pressure in the helmet may become negative due to peak inhalation flow when working at very high work rates. Low airflow will decrease the level of protection provided.

RESPIRATOR SETUP AND CARE

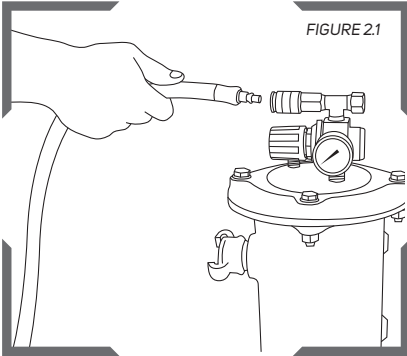

Connect the RPB® Safety NOVA 2000® Air Supply Hose to a breathing air source supplying Grade D or better quality air. Connect the respirator quick disconnect fitting onto the Air Supply Hose.

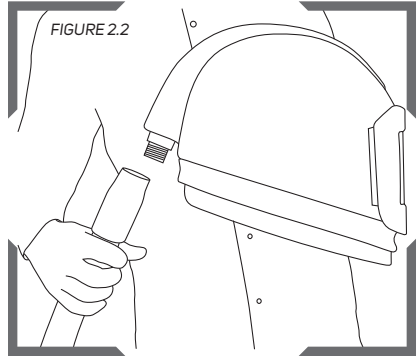

When attaching the breathing tube to the helmet, attach the fixed end of the breathing tube hose to the helmet fitting and the loose running nut to the flow control valve.

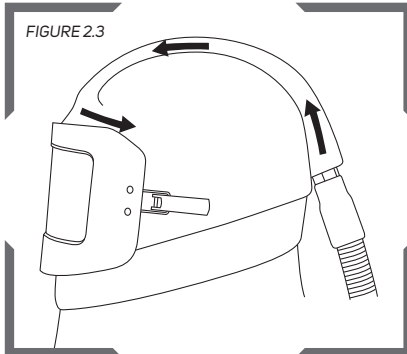

With air flowing through the respirator adjust the air pressure at the point of attachment to the recommended pressure as specified in the Breathing Air Pressure Table (pages 13-14).

NOTE:

Check the hose connections for any air leaks and tighten if necessary - replace any worn parts.



WARNING

The NOVA 2000® Supplied Air Respirator must be supplied with respirable air meeting the requirements of CGA G-7.1 Grade D or higher quality and meets OSHA or other governing body requirements.

RESPIRATOR SETUP AND CARE CONTINUED

LENSES

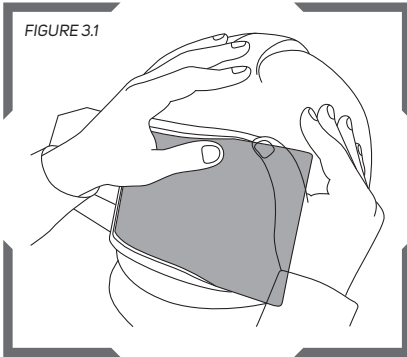

Make sure you have an RPB[®] inner lens securely fitted into the window frame gasket.

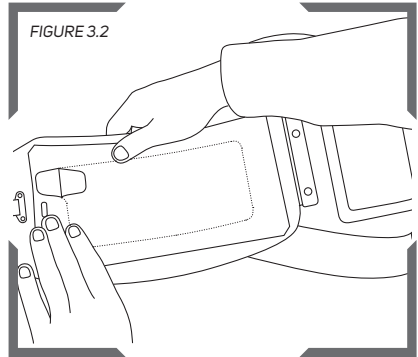

Fit an outer lens onto the tabs on the visor, fold the visor onto the helmet and secure it with latch, making sure there are no gaps between the visor and the window frame gasket.

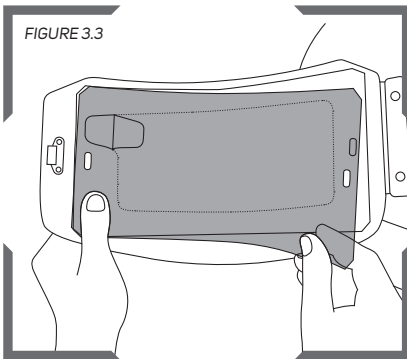

Optional tear-off lenses can be used with the outer lens. It is recommended to use 2-3 tear-off lenses and an outer lens for extra protection.

DONNING AND DOFFING



WARNING

Always check the interior of the respirator for contaminants before donning. Always don and doff the helmet while outside the work area, keeping the interior of the helmet clean and free of contaminants. Not doing these steps could expose you to hazardous materials and contaminants that could impair the function of the respirator.

DONNING YOUR HELMET

Once you have completed the set up, you are ready to fit your RPB® NOVA 2000®. Firstly check inside the helmet to ensure that it is free of dust, dirt or contaminants. Then open the bottom of the cape or face seal, with the air flowing from the air source, put the respirator onto your head. Pull the cape down or make sure the face seal is sealing around your face/neck. Make sure the visor is securely latched.

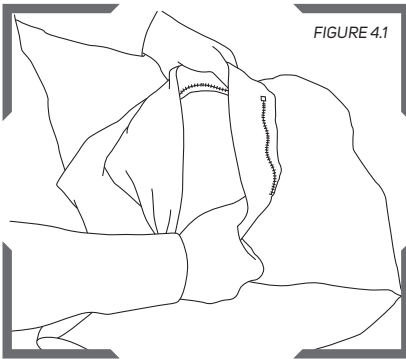

FIGURE 4.1

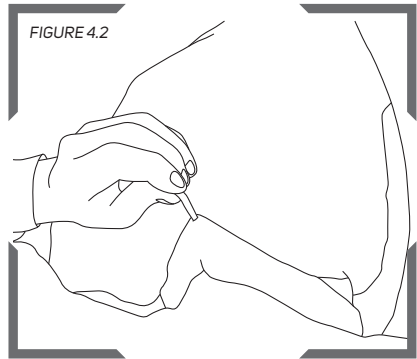
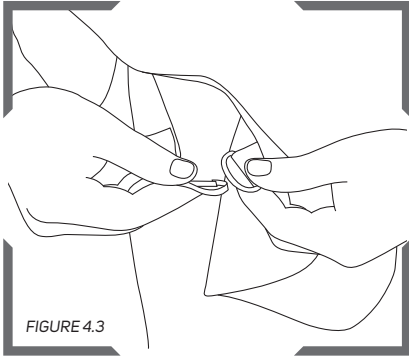

FIGURE 4.2

With air flowing into your respirator fold back the cape, open the inner bib and place your fingers on the inner bib and the side of the helmet at approximately ear position, lift the helmet and place onto your head.

Pull the inner bib around your neck and adjust the elastic cord to ensure a snug fit around your neck - this helps provide a barrier to airborne contaminants.

DONNING AND DOFFING CONTINUED



Regular Capes: Pull the respirator cape around your body and fasten the snap hooks on each side of the cape.

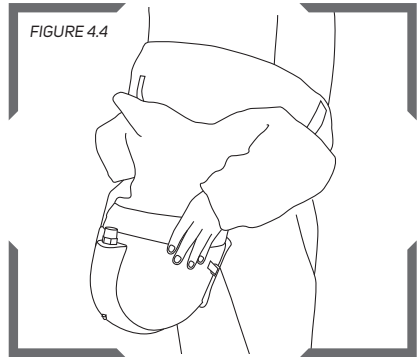

Blast Jackets (NV2002HB Series): Put your arms through the arm holes then pull the jacket down around your waist.

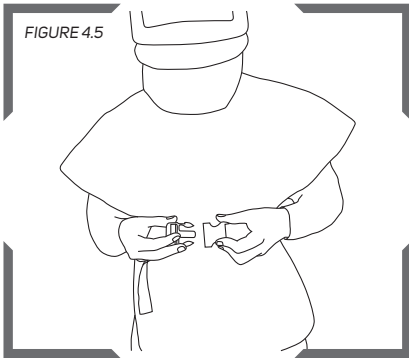

Fasten the belt at waist or hip level and adjust for comfort. Rotate the belt holder until it is in the hip pocket area.

DOFFING YOUR HELMET

When you have finished working leave the work area wearing the respirator with air still flowing into the helmet. Depending on the contaminants, it may be advisable to clean the exterior of the helmet and your work garments before removing the respirator. A workplace cleaning program may be necessary.

STORAGE

After use, clean the respirator according to your company's cleaning program or the directions in this manual. Then let it dry, and store the respirator by hanging it up in a clean, dry place, away from the work area. Do not tuck the cape into the helmet if it has not been thoroughly cleaned. Before storing the respirator for an extended period of time, clean the unit following the cleaning instructions in this instruction manual. It is recommended to store the respirator in a container or storage bag. Store in a cool dry place between -10°C to +45°C (14°F to 113°F) <90%rh.

INSPECTION AND CLEANING

HELMET AND LININGS

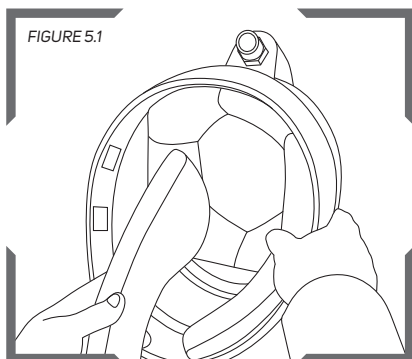

The helmet linings can be removed and sponged with warm water and a gentle detergent, then air dried before refitting into the helmet.

NOTE:

The leather cape must be cleaned with an approved leather cleaner.

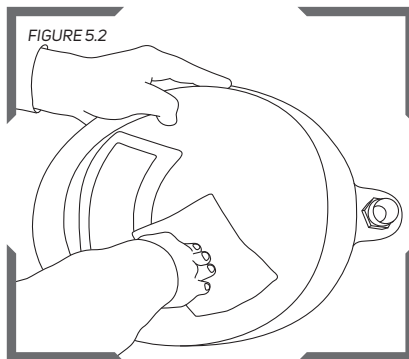

The helmet shell and window frame gasket can be sponged with warm water and a gentle detergent, rinsed and air dried.

BREATHING TUBE ASSEMBLY

Inspect the Breathing Tube NV2021 for splits or excessive wear. Check that the fittings are secured into the tube and are not allowing any air to escape. Replace the tube as soon as signs of damage or excessive wear become evident. Do not remove the foam that is inside the Breathing Tube as it reduces the noise level of the incoming air. The outside Breathing Tube can be cleaned with warm water and a mild detergent, rinsed and air dried. Do not run water through the Breathing Tube.

BREATHING AIR LINE

The air supply hose should be inspected for cuts, cracks, blisters and signs of abrasion. Make sure the fittings are firmly crimped to the hose and air cannot escape. Make sure the hose has not been crushed or kinked. Replace the hose immediately if there are any signs of damage. Do not run water through the inside of the hose. Clean the Quick Disconnect Couplings with an air blow gun to remove any media or dirt that may jam the coupler.

LENSES AND LENS GASKETS

Check Inner Lens Gasket (NV2003) for splits, cracks or wear and tear. Replace any damaged or worn parts immediately with RPB® genuine parts. The Inner Gasket can be cleaned with warm water and a mild detergent, rinsed and air dried.

PARTS AND ACCESSORIES

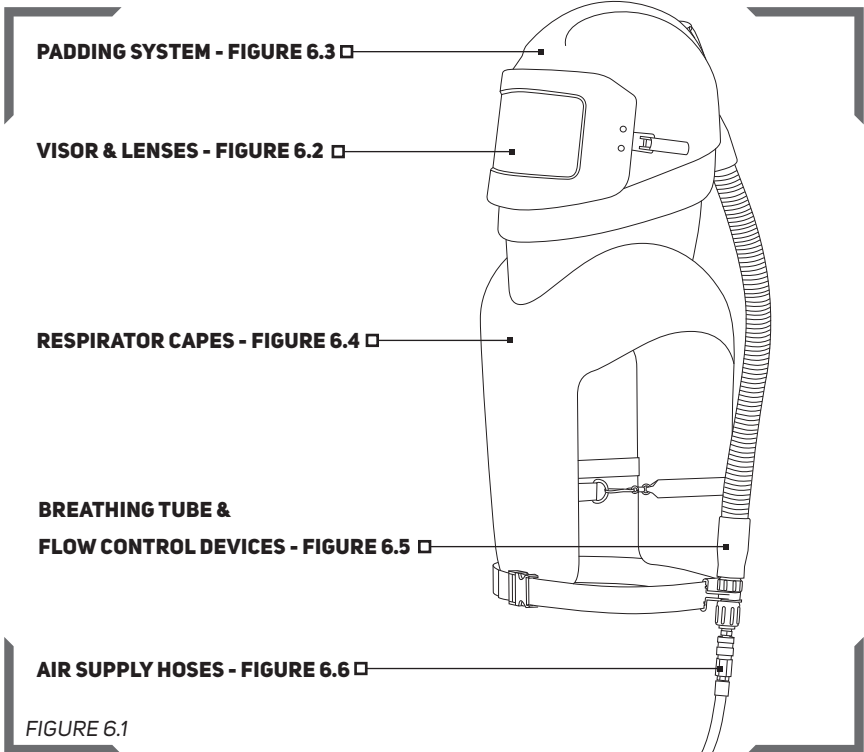

FIGURE 6.1



WARNING

Use only exact, authentic RPB[®] replacement parts (marked with the RPB[®] logo and part number), and only in the specified configuration. Using incomplete or inappropriate equipment, including the use of counterfeit or non-RPB[®] parts, can result in inadequate protection and will void the NIOSH approval of the entire respirator assembly.

VISOR AND LENSES *FIGURE 6.2*

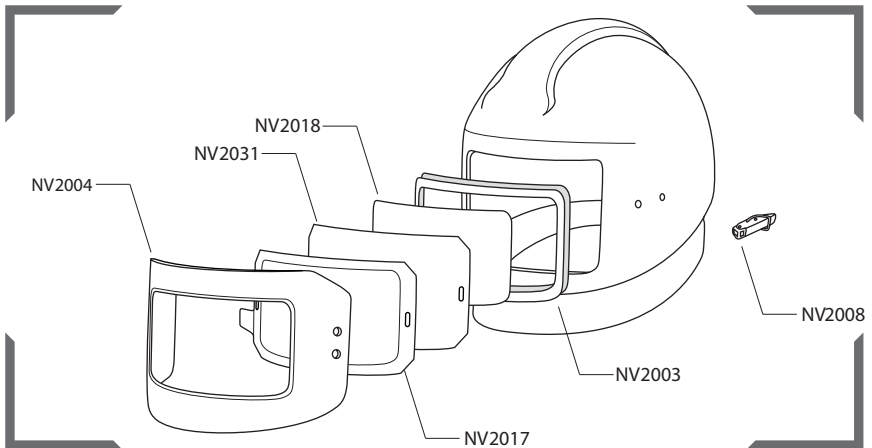

- NV2003 Window Frame Gasket
- NV2004 Visor with Hinge and Screws
- NV2017 Tearoff Lens Packet 50

- NV2018 Inner Lens Packet 10
- NV2031 Outer Lens Packet 50
- NV2008 Latch

PADDING SYSTEM *FIGURE 6.3*

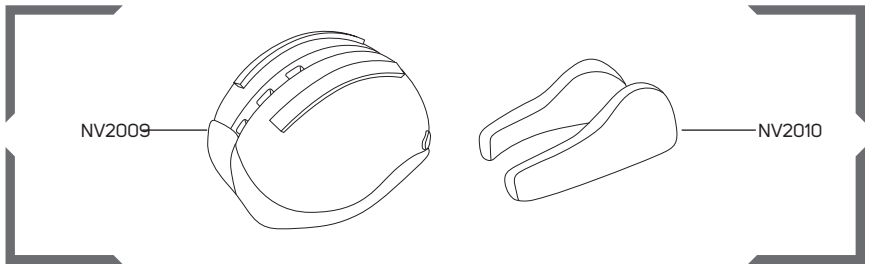

- NV2009 Polystyrene Helmet Liner (Sizes S, M & L)

- NV2010 Sidewings (Sizes S, M & L)

PARTS AND ACCESSORIES CONTINUED

RESPIRATOR CAPES FIGURE 6.4

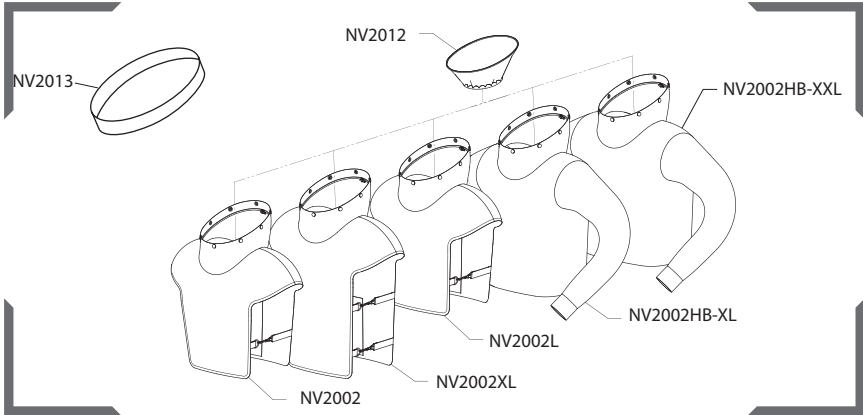





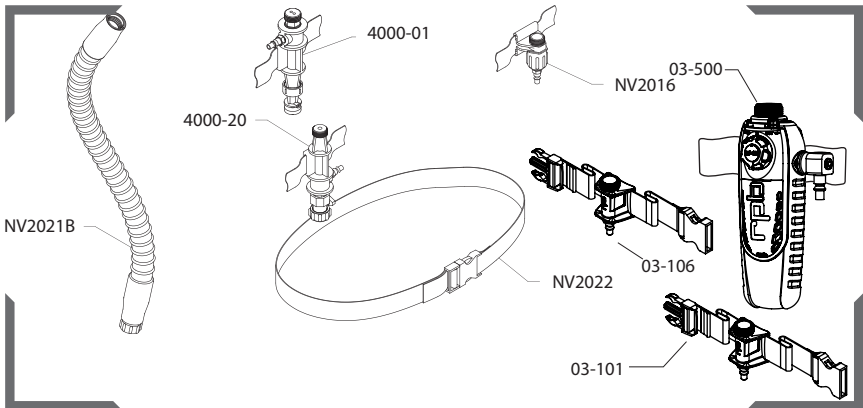

NV2002	28" Nylon Cape	NV2002HB-XXL	Blast Jacket Size XXL
NV2002XL	38" Nylon Cape	NV2012	Inner Bib
NV2002L	28" Leather Cape	NV2013	Cape Cover Band
NV2002HB-XL	Blast Jacket Size XL		

BREATHING TUBE & FLOW CONTROL DEVICES FIGURE 6.5



NV2021	Breathing Tube	4000-20	Hot Air Tube Assembly - Includes: Hot Air Tube, Belt
NV2022	Belt	03-500	Climate Control Assembly - Includes: 03-501, Belt
NV2016	Flow Control Valve Assembly - Includes: Flow Control Valve, Belt	03-106	Constant Flow Valve - Low Pressure
03-106	Constant Flow Valve - Low Pressure	03-101	Constant Flow Valve
4000-01	Cool Air Tube Assembly - Includes: Cool Air Tube, Belt		

AIR SUPPLY HOSES FIGURE 6.6

Series	1. Couplers	2. Plugs	3. Supplied-Air Hose Assemblies
RPB Quick Disconnect 	NV2025 1/4" FM NPT		NV2028 RPB 25ft 3/8" NV2029 RPB 50ft 3/8" NV2027 RPB 100ft 3/8"
Schrader Twist Lock 	03-042-CF 1/4" FM NPT	03-042-PM 1/4" M NPT 03-043-PM 3/8" M NPT 03-042-PMS 1/4" M NPT SWIVEL 	04-342-25 Schrader 25ft 04-342-50 Schrader 50ft 04-342-100 Schrader 100ft
RPB Low Pressure 	NV2037 3/8" Hose Barb	NV2034 3/8" Hose Barb 	NV2035 RPB 50ft NV2036 RPB 100ft
RPB RZ Quick Connect 	03-052-CB-RZ RZ Coupler	03-052-PB-RZ RZ Plug Hose Tail 03-052-PM-RZ RZ Plug 1/4" Male Thread 03-052-PMS-RZ RZ Swivel Plug 	04-352-25 RZ 25ft 04-352-50 RZ 50ft 04-352-100 RZ 100ft

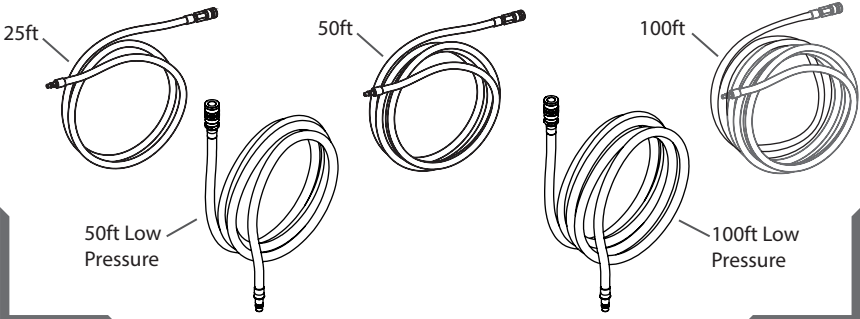

LIMITED WARRANTY

RPB® warrants that its Products will be free from defects in materials and workmanship for one (1) year, subject to the terms of this limited warranty. The Products are sold only for commercial use, and no consumer warranties apply to the Products. This limited warranty is for the benefit of the original Product purchaser, and cannot be transferred or assigned. This is the sole and exclusive warranty provided by RPB®, and ALL CONDITIONS AND IMPLIED WARRANTIES (INCLUDING ANY WARRANTY OF MERCHANTABILITY OR FITNESS FOR A PARTICULAR PURPOSE) ARE EXCLUDED AND DISCLAIMED FROM WARRANTY COVERAGE. RPB's® limited warranty coverage does not apply to damage resulting from accident, improper use or misuse of the Products, wear and tear resulting from the normal use of the Products, or the failure to properly maintain the Products.

RPB's® limited warranty coverage runs from the original date of purchase of the Products, and applies only to warranted defects which first manifest themselves and are reported to RPB® within the warranty period. RPB® retains the right to determine to its reasonable satisfaction whether any claimed defect is covered by this limited warranty.

If a warranted defect occurs, RPB® will repair or replace the defective Product (or a component of the Product), in its sole discretion. This "repair or replacement" remedy is the sole and exclusive remedy under this limited warranty, and under no circumstances shall RPB's® liability under this limited warranty exceed the original purchase price for the Products (or the applicable component). RPB® has no responsibility for incidental or consequential damages, including loss of use, maintenance and other costs, and ALL INCIDENTAL AND CONSEQUENTIAL DAMAGES ARE EXCLUDED AND DISCLAIMED from this limited warranty. Contact RPB® to obtain warranty service. Proof of purchase must be provided to obtain warranty service. All costs of returning the Products to RPB® for warranty service must be paid by the purchaser.

RPB® reserves the right to improve its Products through changes in design or materials without being obligated to purchasers of previously manufactured Products.

LIABILITY

RPB® Safety cannot accept any liability of whatsoever nature arising directly or indirectly from the use or misuse of RPB® Safety products, including purposes that the products are not designed for. RPB® Safety is not liable for damage, loss or expense resulting from the failure to give advice or information or the giving of incorrect advice or information, whether or not due to RPB® Safety's negligence or that of its employees, agents or subcontractors.

PROPOSITION 65 - CALIFORNIA RESIDENTS

WARNING: This product contains a chemical known to the State of California to cause cancer.

WARNING: This product contains a chemical known to the State of California to cause birth defects or other reproductive harm.

NOTES

A series of horizontal dotted lines for writing notes.

NOTES

A series of horizontal dotted lines for writing notes.

OTHER PRODUCTS

ISO9001
ACCREDITED COMPANY

RPB® C40™ CLIMATE CONTROL

Looking for an advanced climate control device that can heat and cool your supplied air just by the slide of a lever? Look no further than the RPB® C40™. From the searing heat of an Arizona summer to a severe Scandinavian winter the RPB® C40™ will keep you comfortable.



AIRLINE FILTRATION

The RPB® RADEX AIRLINE FILTER™ offers increased capacity, versatility and filtration. This optional equipment combines the versatility of either floor or wall mounting with increased filtration capacity, enabling customization to meet worker's needs and working environments.

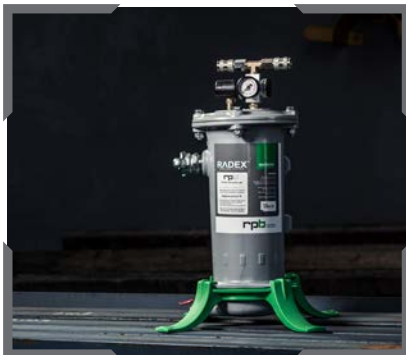

AIR QUALITY MONITORING

Do you need an intelligent gas monitor that can give you complete confidence in the air you and your employees are breathing? The RPB® GX4® Gas Monitor has the ability to detect up to 4 gases simultaneously, giving you total peace of mind.



1-866-494-4599
RPBSAFETY.COM

rpb®