

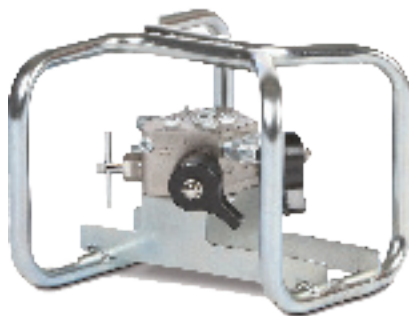

PLURAL COMPONENT SPRAYER ACCESSORIES



PART NUMBERS AND SCHEMATICS GUIDE

Company Profile

Since 1944, Marco has developed a strong tradition of providing innovative and reliable products and services to the surface preparation and protective coatings industries. We are the world's premier provider of Abrasives, Blasting Equipment, Coating Equipment, Engineered Systems, Rental Equipment, Safety Equipment, Service, and Repair.

Through innovative designs and a total commitment to quality, Marco manufactures products that increase production rates, create a safer workplace, and reduce maintenance costs. Marco's industry experience, manufacturing capabilities, legendary customer service, product availability, logistics services, and technology leadership is your assurance that we deliver high quality products and services, providing the best value to you, our customer.

The Marco Difference

- **Industry Experience** – With Marco on your team, you have access to expertise which can only come from decades of industry leadership. We have organized our engineering department, production specialists, customer operations, and safety support into a "Center of Competence." As a Marco customer, you have access to hundreds of years of cumulative experience related to your operations.
- **Manufacturing Excellence** – Marco is a U.S. based, ISO 9001:2008 certified manufacturer of equipment for the Surface Preparation and Protective Coatings industries. Marco's engineers benchmark the industry to ensure that we design and manufacture superior products that set the "Gold Standard" for performance, safety, and quality.
- **Legendary Customer Service** – Marco's legendary customer service team is staffed by friendly, highly-trained individuals who are focused on providing the highest level of product support, order accuracy, and customer satisfaction.
- **Product Availability** – We stock over 10,000 SKU's and have over 45 shipping locations to serve North American and International markets for all major brands of blasting and painting equipment. As the largest provider of surface preparation and protective coatings equipment in the world, our inventory levels and product availability are unmatched.
- **Logistics Services** – Marco's in-house logistics team is dedicated to moving your shipment anywhere in the world. We move over 14,000 truckloads every year, allowing you to save on freight costs by leveraging our buying power. Lower your process costs with a single invoice, which includes product and freight.
- **Technology Leadership** – Our website provides: Operator's Manuals, Part Numbers and Schematics Guides, MSDS information, and Features, Advantages, and Benefits Guides, providing access to information 24/7. Our Extranet application allows you to receive quotes and place orders online. Our Intranet maintains a complete record of your purchase history to assist with ongoing support of your existing equipment and future purchasing decisions.

Vision Statement

Marco is the world's premier provider of Abrasives, Blasting Equipment, Coating Equipment, Engineered Systems, Rental Equipment, Safety Equipment, Service, and Repair.

Mission Statement

Marco provides strong leadership and innovation to the surface preparation and protective coatings industries. We dedicate our efforts to the continuous improvement of our products, services, processes, people, and most importantly, the quality of our customer's experience.

Quality Policy

Marco is committed to providing superior quality in the design, manufacturing, distribution, rental, service, and repair of our products. Our ISO 9001:2008 certification extends throughout all operations in all locations. Continuous improvement of our processes and supply chain Integration comprise the core of our business strategy for delivering exceptional quality and value in all Marco products and services.

Management Philosophy

We are a company dedicated to the success of every customer and associate. We discuss, debate, challenge, measure, and test our ideas. We will be boundless and limitless in our passion to improve. Through sound leadership and dedicated associates, we will ensure a long term, profitable future for Marco, our associates, customers, and suppliers.

TABLE OF CONTENTS

Company Profile	2
Table of Contents	3
Plural Component Spray System	
Accessories	4-11
Heated Hose Bundles 7000 PSI.....	4-5
Heated Hose Bundles 5000 PSI.....	6-7
Water Heated Hose Bundles	8
Band Heaters	9
Powerblanket®	9
Powerblanket® Repair Kit	9
Drum Repair Kit	9
1000 Millileter Test Beaker	10
Jiffy Mixers	10
Reversible Drill	10
Static Mixers	11
Static Mixer Replacement Parts	11
Spiral Bell Mixers	11
Graco® Gun Splitter	12
Maintenance Notes	13-15

PART NUMBERS AND SCHEMATICS GUIDE

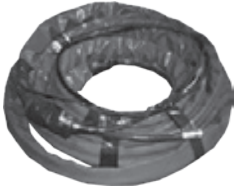
		NON-RECIRCULATION GENERAL PURPOSE 5000 PSI ELECTRIC HEATED HOSE BUNDLES							
		Length				1/2" Fluid Hose	3/8" Fluid Hose	1/4" Fluid Hose	1/4" Flush Hose
		50 Ft	100 Ft	150 Ft	200 Ft				
	Part Numbers								
	20000024	X				1	1	1	1
	20000025		X			1	1	1	1
	20100431			X		1	1	1	1
	20100432				X	1	1	1	1
20100982	X				2			1	

		RECIRCULATION GENERAL PURPOSE 5000 PSI ELECTRIC HEATED HOSE BUNDLES									
		Length				1/2" Fluid Hose	3/8" Fluid Hose	1/4" Fluid Hose	3/8" Fluid Recirculating Hoses	1/4" Moisture-Lock Hose	1/4" Flush Hose
		50 Ft	100 Ft	150 Ft	200 Ft						
	Part Numbers										
	20000052	X				1	1		2		1
	20000053		X			1	1	1	2		1
	20100433			X		1	1		2		1
	20100434				X	1	1	1	2		1
20101025		X			1			2	1	1	

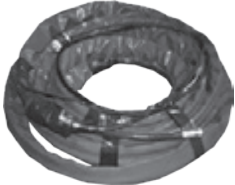
		MOISTURE-LOK 5000 PSI ELECTRIC HEATED HOSE BUNDLES						
		Length				3/8" Fluid Hose	1/4" Moisture-Lock Hose	1/4" Flush Hose
		50 Ft	100 Ft	150 Ft	200 Ft			
	Part Numbers							
	20000013		X			1	1	1
	20000015	X				1	1	1
	20100447			X		1	1	1
20100448				X	1	1	1	

PART NUMBERS AND SCHEMATICS GUIDE

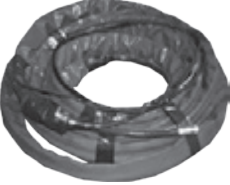
		NON-RECIRCULATION HAZARDOUS LOCATION 5000 PSI ELECTRIC HEATED HOSE BUNDLES							
		Length				1/2" Fluid Hose	3/8" Fluid Hose	1/4" Fluid Hose	1/4" Flush Hose
		50 Ft	100 Ft	150 Ft	200 Ft				
Part Numbers	50 Ft	100 Ft	150 Ft	200 Ft	1/2" Fluid Hose	3/8" Fluid Hose	1/4" Fluid Hose	1/4" Flush Hose	
	20100436	X				1	1	1	1
	20100437		X			1	1	1	1
	20100438			X		1	1	1	1
	20100439				X	1	1		1
	20101070	X					2		1

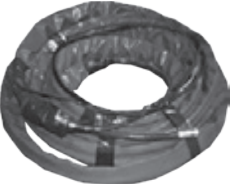
		RECIRCULATION HAZARDOUS LOCATION 5000 PSI ELECTRIC HEATED HOSE BUNDLES							
		Length				1/2" Fluid Hose	3/8" Fluid Hose	3/8" Fluid Recirculating Hoses	1/4" Flush Hose
		50 Ft	100 Ft	150 Ft	200 Ft				
Part Numbers	50 Ft	100 Ft	150 Ft	200 Ft	1/2" Fluid Hose	3/8" Fluid Hose	3/8" Fluid Recirculating Hoses	1/4" Flush Hose	
	20100440	X				1	1	2	1
	20100441		X			1	1	2	1
	20100442			X		1	1	6	1
	20100443				X	1	1	2	1

PART NUMBERS AND SCHEMATICS GUIDE

		NON-RECIRCULATION GENERAL PURPOSE 7000 PSI ELECTRIC HEATED HOSE BUNDLES							
		Length				1/2" Fluid Hose	3/8" Fluid Hose	1/4" Fluid Hose	1/4" Flush Hose
Part Numbers		50 Ft	100 Ft	150 Ft	200 Ft				
	20100226			X		1	1	1	1
	20100258		X			1	1	1	1
	20100272	X				1	1	1	1
	20100450				X	1	1	1	1
	20101043		X				1	1	1
	20101195		X			2			1

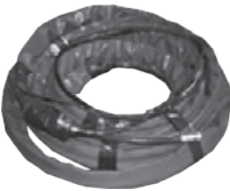
		RECIRCULATION GENERAL PURPOSE 7000 PSI ELECTRIC HEATED HOSE BUNDLES									
		Length				1/2" Fluid Hose	3/8" Fluid Hose	1/4" Fluid Hose	3/8" Fluid Recirculating Hoses	1/4" Flush Hose	
Part Numbers		50 Ft	100 Ft	150 Ft	200 Ft						
	20100451	X				1	1	1	2	1	
	20100452		X			1	1	1	2	1	
	20100453				X		1	1	1	2	1
	20100454					X	1	1	1	2	1
	20100747	X					1	1		2	1
	20100758			X			2			2	1

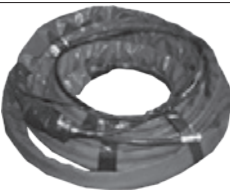
		MOISTURE-LOK 7000 PSI ELECTRIC HEATED HOSE BUNDLES						
		Length				3/8" Fluid Hose	1/4" Moisture-Lock Hose	1/4" Flush Hose
Part Numbers		50 Ft	100 Ft	150 Ft	200 Ft			
	20100466	X				1	1	1
	20100467		X			1	1	1
	20100468				X		1	1
	20100469					X	1	1

PART NUMBERS AND SCHEMATICS GUIDE

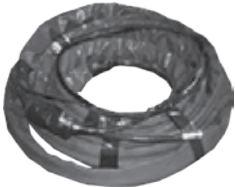
		NON-RECIRCULATION HAZARDOUS LOCATION 7000 PSI ELECTRIC HEATED HOSE BUNDLES							
		Length				1/2" Fluid Hose	3/8" Fluid Hose	1/4" Fluid Hose	1/4" Flush Hose
		50 Ft	100 Ft	150 Ft	200 Ft				
	Part Numbers								
	20100456	X				1	1	1	1
	20100457		X			1	1	1	1
	20100458			X		1	1	1	1
	20100459				X	1	1	1	1

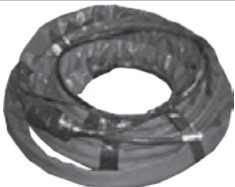
		RECIRCULATION HAZARDOUS LOCATION 7000 PSI ELECTRIC HEATED HOSE BUNDLES								
		Length				1/2" Fluid Hose	3/8" Fluid Hose	1/4" Fluid Hose	3/8" Fluid Recirculating Hoses	1/4" Flush Hose
		50 Ft	100 Ft	150 Ft	200 Ft					
	Part Numbers									
	20100073	X				1	1	1	2	1
	20100074		X			1	1	1	2	1
	20100460			X		1	1	1	2	1
	20100461				X	1	1	1	2	1

PART NUMBERS AND SCHEMATICS GUIDE

NON-RECIRCULATION GENERAL PURPOSE 5000 PSI WATER HEATED HOSE BUNDLES



	Part Numbers	Length				1/2" Fluid Hose	3/8" Fluid Hose	1/4" Fluid Hose	3/8" Fluid Recirculating Hoses	1/4" Flush Hose
		50 Ft	100 Ft	150 Ft	200 Ft					
			20100444	X						
	20100445		X			4		1	2	1
	20100446			X		1	1		2	1
	20100253				X	4			2	

NON-RECIRCULATION GENERAL PURPOSE 7000 PSI WATER HEATED HOSE BUNDLES

	Part Numbers	Length				1/2" Fluid Hose	3/8" Fluid Hose	1/4" Fluid Hose	3/8" Fluid Recirculating Hoses	1/4" Flush Hose
		50 Ft	100 Ft	150 Ft	200 Ft					
			20100462	X						
	20100463		X			1	1	1	2	1
	20100464			X		1	1	1	2	1
	20100465				X	1	1	1	2	1

PART NUMBERS AND SCHEMATICS GUIDE

		BAND HEATERS			
Part Numbers		Drum Size	Voltage	Diameter	Shipping Weight
	20EXTRX5HR110V	5 Gallon	120-Volt	11-1/4"	7 lbs.
	20EXTRX55HR240V	55 Gallon	240-Volt	22-1/2"	14 lbs.







		POWERBLANKET®				
Part Numbers		Size/Style	Voltage	Series	Thermostat	Shipping Weight
	2070021	55 Gallon	120-Volt	Standard	Preset to 100°F	13 lbs.
	2070022	55 Gallon	120-Volt	Pro	Adjustable up to 145°F	13 lbs.
	2070023	55 Gallon	240-Volt	Pro	Adjustable up to 145°F	13 lbs.
	2070024	5 Gallon	120-Volt	Standard	Preset to 100°F	4 lbs.
	2070025	Hot Box	120-Volt	Pro	Preset to 120°F	59 lbs.

		POWERBLANKET® REPAIR KIT
	2070026	Powerblanket® Surface Repair Kit

Part Numbers		DRUM VENT
		Description
	20100549	55-Gallon Desiccant Vent Kit For Drying Ambient Air in Drum During Storage

PART NUMBERS AND SCHEMATICS GUIDE



1000 MILLILITER TEST BEAKER		
	20BEAKER1000ML	1000 Milliliter Test Beaker



JIFFY MIXERS								
	Part Numbers	Container Size	Shaft Length	Shaft Diameter	Top Diameter	Bottom Diameter	Material of Construction	U.O.M.
	20JMHS2	1-2 Gallon	14-3/4"	1/4"	2-5/8"	2-5/8"	Stainless Steel	One Each
	20JHS3	1-2 Gallon	30"	1/4"	2-5/8"	2-5/8"	Stainless Steel	One Each
	20JMES210	2-5 Gallon	20-1/2"	3/8"	3-1/4"	3-3/4"	Stainless Steel	One Each
	20JMPS1	5-10 Gallon	20-1/2"	1/2"	3-1/4"	3-3/4"	Stainless Steel	One Each
	20JPS227	10-50 Gallon	27-1/2"	1/2"	4-5/8"	5-1/8"	Stainless Steel	One Each
	20JPS2	10-50 Gallon	40"	1/2"	4-5/8"	5-1/8"	Stainless Steel	One Each

REVERSIBLE DRILL		
	10HF936510VGA	1/2" Reversible Pneumatic Air Drill

PART NUMBERS AND SCHEMATICS GUIDE

		STATIC MIXERS					
Part Numbers		Diameter	Number of Mixing Elements	Length	PSI	Housing Material	Element Material
	20TAH100206	1/4"	6	3.75"	8500	Stainless Steel	Stainless Steel
	20TAH100212	1/4"	12	7"	8500	Stainless Steel	Stainless Steel
	20TAH100312	3/8"	12	9.5"	7250	Stainless Steel	Stainless Steel
	20TAH7700195	3/8"	30	13.12"	7250	Stainless Steel	Plastic
	20TAH100412	1/2"	12	11"	7250	Stainless Steel	Stainless Steel
	20TAH100612	3/4"	12	14.75"	6000	Stainless Steel	Stainless Steel

		STATIC MIXER REPLACEMENT PARTS	
Part Numbers		Description	Quantity
	20TAH090312	3/8" x 12 Stainless Steel Mixing Elements	One Each
	20G262478	1/2" x 5" Static Mix Housing	One Each
	20G248927	1/2" Plastic Mixing Element	25/Package

		SPIRAL BELL MIXER			
Part Numbers		Diameter	PSI	Length	Number of Mixing Elements
	20TAH7701028	1/2"	270	14"	30
	20TAH7701059	3/4"	580	17"	23

PART NUMBERS AND SCHEMATICS GUIDE

Figure 1: Graco® Gun Splitter

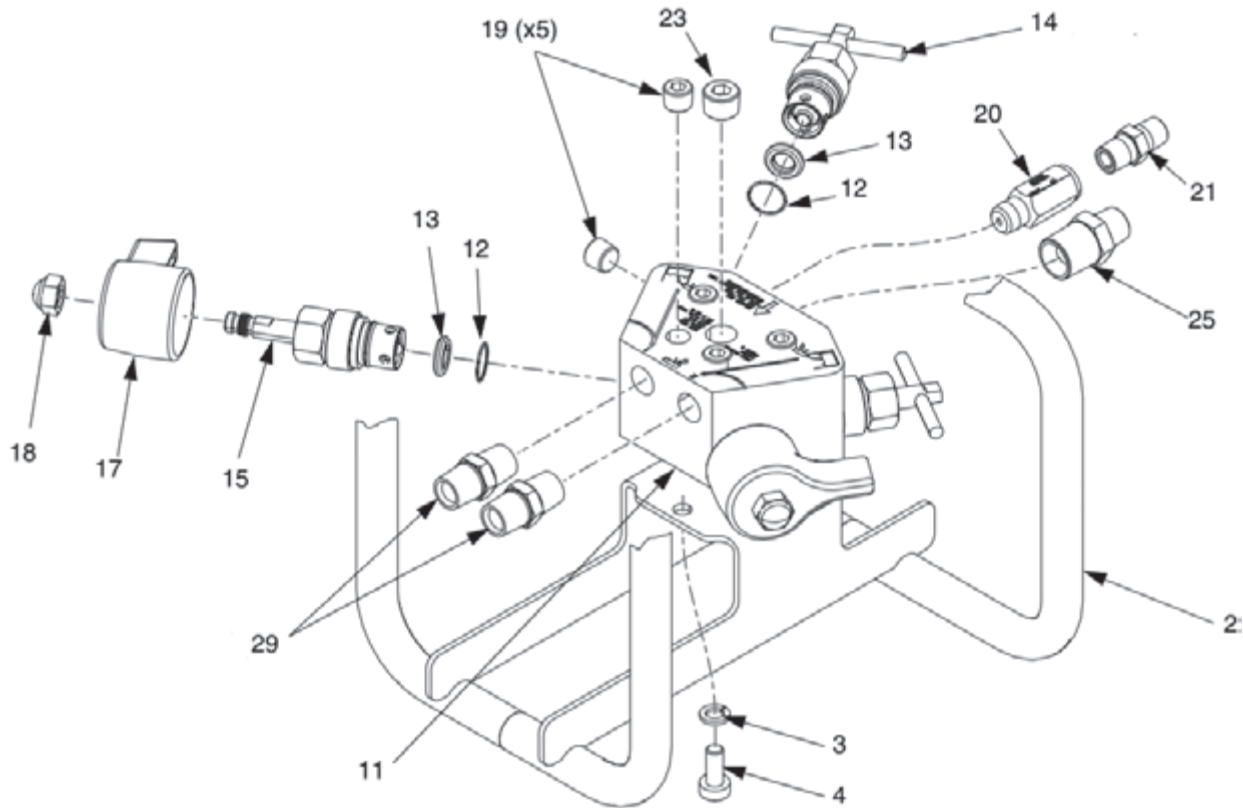

Item #	Part #	Description
Fig. 1		
—	20G262826	Graco® Gun Splitter – Complete
1	—	Valve Splitter <i>Includes Item #'s: 11-29</i>
2	20G262816	Remote Valve Carriage
3	20G100214	Lock Washer <i>(Three Required)</i>
4	20G558673	5/16-18 x 3/4" Screw <i>(Three Required)</i>
11	20G262822	Gun Splitter Body
12	20G195136	PTFE O-ring <i>(Four Required)</i>
13	20G195132	Carbide Seat <i>(Four Required)</i>
14	20G24M220	Solvent Cartridge Valve <i>(Two Required)</i>
15	20G24M219	Pain Cartridge Valve <i>(Two Required)</i>
17	20G15R381	Handle <i>(Two Required)</i>
18	20G117623	3/8-16 Cap Nut <i>(Two Required)</i>
19	20G100721	1/4" NPT Pipe Plug <i>(Five Required)</i>
20	20G563210	1/4" NPT Check Valve, 5000 PSI
21	20G156971	1/4" NPT Nipple
23	20G101754	3/8" NPT Pipe Plug
25	20G159239	Reducing Pipe Nipple <i>(Two Required)</i>
29	20G156849	3/8" NPT Pipe Nipple <i>(Two Required)</i>
—	20G24M213	Valve Seal Repair Kit <i>Includes Item #'s: 12 and 13</i>

GLOBAL HEADQUARTERS

- 3425 East Locust Street
Davenport, IA 52803

ph: 800.BLAST.IT (800.252.7848)

ph: 563.324.2519

fax: 563.324.6258

REGIONAL BRANCH OFFICES

- **Iowa**
Davenport
- **Louisiana**
Gonzales
Lafayette
- **Ohio**
Youngstown
- **Texas**
Beaumont
Corpus Christi
Deer Park

40+ NATIONWIDE SHIPPING LOCATIONS



★ Marco Regional Branch Offices
and Shipping Locations

● Direct Shipping Locations



ABRASIVES

BLASTING

COATING

DUST COLLECTORS

ENGINEERED SYSTEMS

RENTAL

SAFETY

SERVICE & REPAIR

VACUUMS

CONTACT MARCO

800.BLAST.IT

(800.252.7848)

563.324.2519

FAX: 563.324.6258

WWW.MARCO.US

SALES@MARCO.US