



# NORTH<sup>®</sup> CARTRIDGE-STYLE RESPIRATORS



**PART NUMBERS AND SCHEMATICS GUIDE**

## Company Profile

Since 1944, Marco has developed a strong tradition of providing innovative and reliable products and services to the surface preparation and protective coatings industries. We are the world's premier provider of Abrasives, Blasting Equipment, Coating and Painting Equipment, Engineered Systems, Rental Equipment, Safety Equipment, Service, and Repair.

Through innovative designs and a total commitment to quality, Marco manufactures products that increase production rates, create a safer workplace, and reduce maintenance costs. Marco's industry experience, manufacturing capabilities, legendary customer service, product availability, logistics services, and technology leadership is your assurance that we deliver high quality products and services, providing the best value to you, our customer.

## The Marco Difference

- **Industry Experience** – With Marco on your team, you have access to expertise which can only come from decades of industry leadership. We have organized our engineering department, production specialists, customer operations, and safety support into a “Center of Competence.” As a Marco customer, you have access to hundreds of years of cumulative experience related to your operations.
- **Manufacturing Excellence** – Marco is a U.S. based, ISO 9001:2008 certified manufacturer of equipment for the Surface Preparation and Protective Coatings industries. Marco's engineers benchmark the industry to ensure that we design and manufacture superior products that set the “Gold Standard” for performance, safety, and quality.
- **Legendary Customer Service** – Marco's legendary customer service team is staffed by friendly, highly-trained individuals who are focused on providing the highest level of product support, order accuracy, and customer satisfaction.
- **Product Availability** – We stock over 10,000 SKU's and have over 45 shipping locations to serve North American and International markets for all major brands of blasting and painting equipment. As the largest provider of surface preparation and protective coatings equipment in the world, our inventory levels and product availability are unmatched.
- **Logistics Services** – Marco's in-house logistics team is dedicated to moving your shipment anywhere in the world. We move over 14,000 truckloads every year, allowing you to save on freight costs by leveraging our buying power. Lower your process costs with a single invoice, which includes product and freight.
- **Technology Leadership** – Our website provides: Operator's Manuals, Part Numbers and Schematics Guides, MSDS information, and Features, Advantages, and Benefits Guides, providing access to information 24/7. Our Extranet application allows you to receive quotes and place orders online. Our Intranet maintains a complete record of your purchase history to assist with ongoing support of your existing equipment and future purchasing decisions.

## Vision Statement

Marco is the world's premier provider of Abrasives, Blasting Equipment, Coating and Painting Equipment, Engineered Systems, Rental Equipment, Safety Equipment, Service, and Repair.

## Mission Statement

Marco provides strong leadership and innovation to the surface preparation and protective coatings industries. We dedicate our efforts to the continuous improvement of our products, services, processes, people, and most importantly, the quality of our customer's experience.

## Quality Policy

Marco is committed to providing superior quality in the design, manufacturing, distribution, rental, service, and repair of our products. Our ISO 9001:2008 certification extends throughout all operations in all locations. Continuous improvement of our processes and supply chain Integration comprise the core of our business strategy for delivering exceptional quality and value in all Marco products and services.



## Management Philosophy

We are a company dedicated to the success of every customer and associate. We discuss, debate, challenge, measure, and test our ideas. We will be boundless and limitless in our passion to improve. Through sound leadership and dedicated associates, we will ensure a long term, profitable future for Marco, our associates, customers, and suppliers.

# TABLE OF CONTENTS

|   |              |
|---|--------------|
| <b>Company Profile</b> .....                            | <b>2</b>     |
| <b>Table of Contents</b> .....                          | <b>3</b>     |
| <b>Cartridge-Style Respirators</b> .....                | <b>4-11</b>  |
| <b>North® 7700 Series Half Face</b>                     |              |
| <b>Mask Respirators</b> .....                           | <b>4-5</b>   |
| Full Face Mask Part Numbers .....                       | 4            |
| Replacement Parts .....                                 | 5            |
| <b>North 5400 Series Full Face</b>                      |              |
| <b>Mask Respirators</b> .....                           | <b>6-7</b>   |
| Full Face Mask Part Numbers .....                       | 6            |
| Full Face Mask Assembly .....                           | 6-7          |
| <b>North 7600 Series Full Face</b>                      |              |
| <b>Mask Respirators</b> .....                           | <b>8-9</b>   |
| Full Face Mask Part Numbers .....                       | 8            |
| Full Face Mask Assembly .....                           | 8-9          |
| <b>North Respirators Cartridges &amp; Filters</b> ..... | <b>10</b>    |
| <b>Disposable Respirators &amp; Masks</b> .....         | <b>11</b>    |
| North Disposable Particulate Respirators .....          | 11           |
| <b>Optional Accessories</b> .....                       | <b>12-13</b> |
| <b>Maintenance Notes</b> .....                          | <b>14-15</b> |





## PART NUMBERS & SCHEMATICS GUIDE

|  |                  | <b>NORTH® 7700 SERIES HALF FACE RESPIRATORS</b> |             |               |
|--|------------------|---|-------------|---------------|
| <b>Part Numbers</b>  |                  | <b>Face Mask</b>                                | <b>Size</b> | <b>U.O.M.</b> |
|  | <b>30NR7700S</b> | Half  | Small       | One Each      |
|  | <b>30NR7700M</b> | Half  | Medium      | One Each      |
|  | <b>30NR7700L</b> | Half  | Large       | One Each      |



105V083 – Brochure – North Cartridge and Filter Reference Chart

109V083 – User Instructions – North 7700 Series Respirators

## PART NUMBERS & SCHEMATICS GUIDE

| <b>NORTH® 7700 SERIES RESPIRATORS<br/>REPLACEMENT PARTS</b>                       |                         |                     |               |
|---|-------------------------|---------------------|---------------|
|   | <b>Part<br/>Numbers</b> | <b>Description</b>  | <b>U.O.M.</b> |
|  | <b>30NR770011L</b>      | Large Facepiece     | One Each      |
|  | <b>30NR770016</b>       | Cartridge Connector | 2/Package     |
|  | <b>30NR770017</b>       | Inhalation Valve    | 6/Package     |
|  | <b>30NR770018</b>       | Exhalation Valve    | 4/Package     |
|  | <b>30NR770092</b>       | Cradle Suspension   | One Each      |

## PART NUMBERS & SCHEMATICS GUIDE

|   |            | NORTH® 5400 SERIES FULL FACE RESPIRATORS |              |          |
|---|------------|--|--------------|----------|
| Part Numbers  |            | Face Mask                                | Size         | U.O.M.   |
|  | 30NR54001S | Full                                     | Small        | One Each |
|  | 30NR54001  | Full                                     | Medium/Large | One Each |

### North® 5400 Series Full Face Respirator



| Item #        | Part #     | Description                                 |
|---------------|------------|---|
| <b>Fig. 1</b> |            |   |
| 2             | 30NR80798  | Upper and Lower Lens Clamps                 |
| 3             | 30NR80798  | Upper and Lower Lens Clamps                 |
| 4             | 30NR80843A | Lens Clamp Screw ( <i>Quantity of Two</i> ) |
| 5             | 30NR80844A | Lens Clamp Nut                              |
| 7             | 30NR54005  | Lens  |
| 8             | 30NR54006  | Oral/Nasal Cup                              |
| 9             | 30NR770017 | Inhalation Valve                            |
| 10            | 30NR80814A | Valve Seat for Oral/Nasal Cup               |
| 11            | 30NR770018 | Exhalation Valve                            |
| 12            | 30NR54007  | Exhalation Housing                          |
| 13            | 30NR54008  | Cover, Exhalation Housing                   |
| 14            | 30NR54003  | Gasket ( <i>Quantity of Five</i> )          |
| 15            | 30NR80871A | Inhalation Connector                        |
| 16            | 30NR770016 | Grommet                                     |

# PART NUMBERS & SCHEMATICS GUIDE

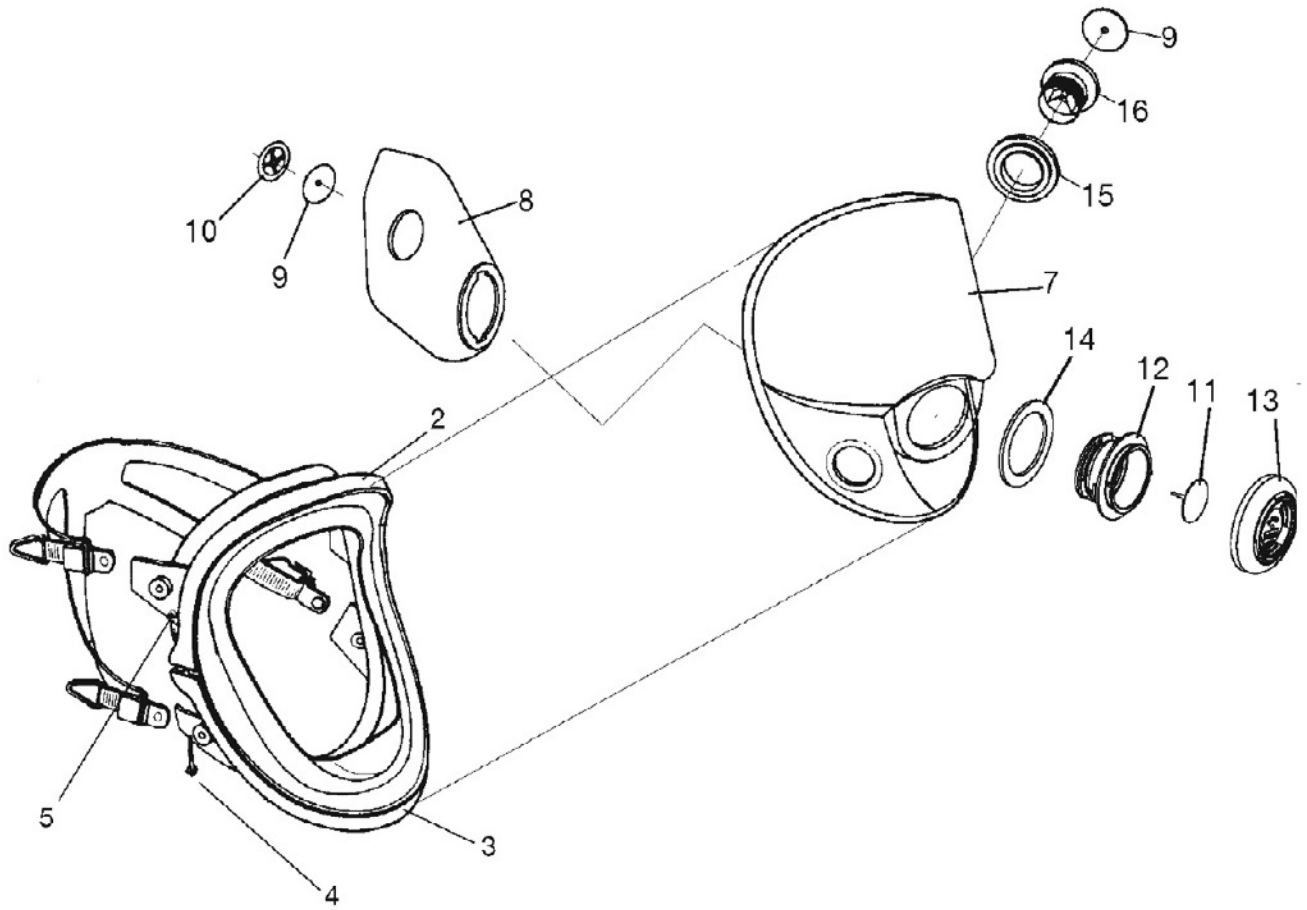
Figure 1: North® 5400 Series Full Face Respirator



## PART NUMBERS & SCHEMATICS GUIDE

|   |                    | <b>NORTH® 7600 SERIES FULL FACE RESPIRATORS</b> |              |               |
|---|--------------------|---|--------------|---------------|
| <b>Part Numbers</b>   |                    | <b>Face Mask</b>                                | <b>Size</b>  | <b>U.O.M.</b> |
|  | <b>30NR76008AS</b> | Full  | Small        | One Each      |
|  | <b>30NR76008A</b>  | Full  | Medium/Large | One Each      |
|  | <b>30NR76008AW</b> | Full WELDING                                    | Medium/Large | One Each      |

### North® 7600 Series Full Face Respirator

| Item #        | Part #     | Description  |
|---------------|------------|--|
| <b>Fig. 2</b> |            |  |
| 2             | 30NR80798  | Upper and Lower Lens Clamps                                |
| 3             | 30NR80798  | Upper and Lower Lens Clamps                                |
| 4             | 30NR80843A | Lens Clamp Screw ( <i>Quantity of Two</i> )                |
| 5             | 30NR80844A | Lens Clamp Nut   |
| 7             | 30NR80846A | Headstrap Latch ( <i>Quantity of Five</i> )                |
| 8             | 30NR80847A | Headstrap Bail, Metal ( <i>Quantity of Five</i> )          |
| 9             | 30NR80848  | Neckstrap Assembly   |
| 10            | 30NR80849  | Lens   |
| 11            | 30NR80852  | Flange   |
| 12            | 30NR80815  | Oral/Nasal Cup, Medium/Large                               |
| 13            | 30NR770017 | Inhalation Valve   |
| 14            | 30NR80814A | Valve Seat for Oral/Nasal Cup                              |
| 15            | 30NR80855  | Locking Ring   |
| 16            | 30NR80856  | Speaker Diaphragm  |
| 17            | 30NR80857A | O-Ring, Speaker Diaphragm                                  |
| 18            | 30NR80858  | Housing, Speaker Diaphragm                                 |
| 19            | 30NR80861A | O-Ring, Speaker Diaphragm Housing                          |
| 20            | 30NR80862  | Adapter Nut  |
| 21            | 30NR80863  | Exhalation Valve Seat                                      |
| 22            | 30NR770018 | Exhalation Valve   |
| 23            | 30NR80867  | Exhalation Valve Guard                                     |
| 24            | 30NR770016 | Cartridge Connector  |
| 25            | 30NR80871A | Inhalation Connector                                       |
| —             | 106V084    | Technical Data Sheet – North 7600 Series Respirators       |
| —             | 109V084    | Operator's Manual – North 5400 and 7600 Series Respirators |







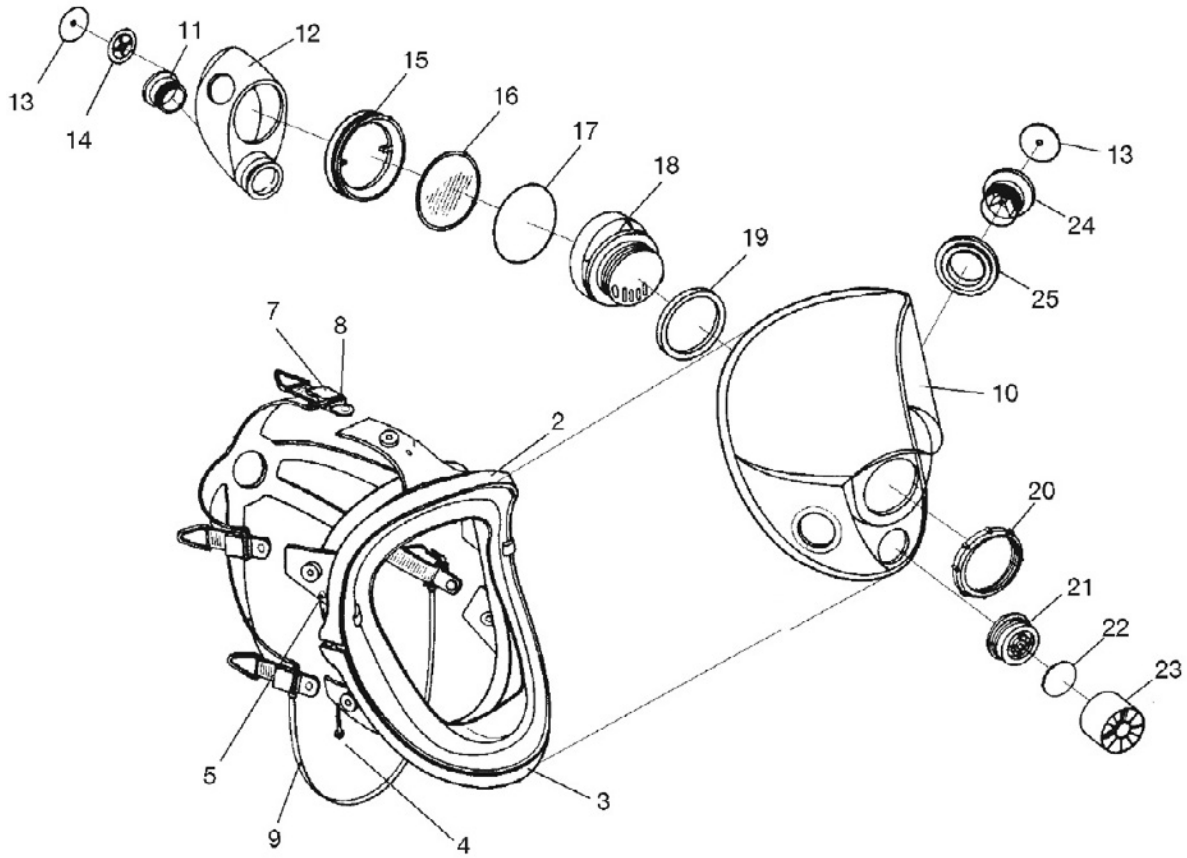





# PART NUMBERS & SCHEMATICS GUIDE

Figure 2: North® 7600 Series Full Face Respirator





## PART NUMBERS & SCHEMATICS GUIDE





| <b>NORTH® RESPIRATORS CARTRIDGES &amp; FILTERS</b>                                  |                     |  |                                |            |
|---|---------------------|--|--------------------------------|------------|
| <b>Part Numbers</b>   | <b>Description</b>  | <b>Color</b>   | <b>U.O.M.</b>                  |            |
|     | <b>30NR460550</b>   | Organic Vapor Cartridge  | Black Lid,<br>Black Label      | 2/Package  |
|     | <b>30NRN75002</b>   | Acid Gas and Formaldehyde Cartridge                            | Black Lid,<br>White Label      | 2/Package  |
|    | <b>30NR7581</b>     | Organic Vapor Cartridge With P100 Particulate Filter           | Pink Lid,<br>Black Label       | 2/Package  |
|    | <b>30NR460585</b>   | Organic Vapor Cartridge With P100 Particulate Filter           | Pink Lid,<br>Yellow Label      | 2/Package  |
|   | <b>30NR75SCP100</b> | Multi-Purpose Cartridge and P100 Particulate Filter            | Pink Lid,<br>Olive Green Label | 2/Package  |
|  | <b>30NR7584P100</b> | Ammonia and Methylamine Cartridge with P100 Particulate Filter | Pink Lid,<br>Green Label       | 2/Package  |
|   | <b>30NR460615</b>   | P100 Particulate Filter  | Pink                           | 2/Package  |
|   | <b>30NR7506N95</b>  | N95 Non-Oil Particulate Filter                                 | White with<br>Blue Text        | 10/Package |
|   | <b>30NR7506N99</b>  | N99 Particulate Non-Oil Filter                                 | White with<br>Black Text       | 10/Package |
|  | <b>30NR75FFP100</b> | Low Profile P100 Particulate Filter                            | Pink                           | 2/Package  |
|   | <b>30NRN750035</b>  | Adapter for 30NR75FFP100                                       | Black                          | One Each   |

105V083 – Brochure – North Cartridge and Filter Reference Chart





## PART NUMBERS & SCHEMATICS GUIDE

|   |                      | <b>NORTH® DISPOSABLE PARTICULATE RESPIRATORS</b> |                |             |               |
|---|----------------------|--|----------------|-------------|---------------|
| <b>Part Numbers</b>   |                      | <b>Style</b>                                     | <b>Filters</b> | <b>Size</b> | <b>U.O.M.</b> |
|  | <b>30NR7190N99</b>   | Metal Fumes from Welding Settings                | N99            | One Size    | 12/Case       |
|  | <b>30NR719009N99</b> | Replacement Filter Only                          | N99            | One Size    | 12/Case       |

## OPTIONAL ACCESSORIES

|   |                   | ALCOHOL WIPES  |             |                                       |               |
|---|-------------------|----------------|-------------|---------------------------------------|---------------|
| <b>Part Numbers</b>   |                   | <b>Brand</b>   | <b>Size</b> | <b>Description</b>                    | <b>U.O.M.</b> |
|  | <b>303M430071</b> | Big Ones       | 8" x 11"    | Individually wrapped                  | 50 Wipes/Box  |
|  | <b>303M430073</b> | Procare        | 5" x 8"     | Individually wrapped                  | 100 Wipes/Box |
|  | <b>303M504</b>    | 3M™            | 8" x 10"    | Individually wrapped,<br>Alcohol-Free | 100 Wipes/Box |
|  | <b>303M660034</b> | PDI® Sani-Dex® | 6" x 7.5"   | Individually wrapped                  | 100 Wipes/Box |

## OPTIONAL ACCESSORIES

| FIT TESTING  |                   |                          |          |                                       |                |
|--|-------------------|--------------------------|----------|---------------------------------------|----------------|
| Part Numbers   | Description       | Manufacturer             | Contents | U.O.M.                                |                |
|   | <b>303MFT10</b>   | Qualitative Fit Test Kit | 3M™      | FT-11, FT-12, FT-14, FT-15, FT-13 (2) | One Kit        |
|   | <b>303M430090</b> | Banana Oil               | Allegro  | 10 Glass Ampules Solution             | 10 Ampules/Box |
|   | <b>303M900601</b> | Fit Test Adapter         | 3M™      | Adapter, Connectors, Hose             | One Kit        |
|   | <b>303MFT12</b>   | Sweet Solution           | 3M™      | Solution                              | 6/Case         |
|  | <b>303MF11</b>    | Saccharin Solution       | 3M™      | Solution                              | 6/Case         |





## GLOBAL HEADQUARTERS

- 3425 East Locust Street  
Davenport, IA 52803

ph: 800.BLAST.IT (800.252.7848)

ph: 563.324.2519

fax: 563.324.6258

## GULF STATES HEADQUARTERS

- 701 East Boulevard  
Deer Park, TX 77536

ph: 800.BLAST.IT (800.252.7848)

ph: 281.930.0905

fax: 281.542.0736

## REGIONAL BRANCH OFFICES

- **Iowa**  
Davenport
- **Louisiana**  
Gonzales  
Lafayette
- **Ohio**  
Youngstown
- **Texas**  
Beaumont  
Corpus Christi  
Deer Park



ABRASIVES

BLASTING

COATING

DUST COLLECTORS

ENGINEERED SYSTEMS

RENTAL

SAFETY

SERVICE & REPAIR

VACUUMS

## 40+ NATIONWIDE SHIPPING LOCATIONS



★ Marco Regional Branch Offices  
and Shipping Locations

● Direct Shipping Locations

## CONTACT MARCO

800.BLAST.IT

(800.252.7848)

563.324.2519

FAX: 563.324.6258

WWW.MARCO.US

SALES@MARCO.US