



# GRACO® FTX™ AIRLESS SPRAY GUNS



PART NUMBERS AND SCHEMATIC GUIDE

## Company Profile

Allredi was formed in the early 2020, when two of the largest distributors in the blasting, coating, safety, and environmental industry, APE Companies and Marco Group International, joined forces. While the qualities both companies are known for have not changed, a lot about our business is new. New abilities. New agilities. New ways to help you win. This calls for a new name, Allredi.

This name exemplifies what we have become. It is completely oriented to the needs of our customers. To your needs. It says that when you call us for anything – products, service, expert advice, anything – you can consider it done. Or even better, Allredi done.

We are your right-now supplier. From skills to SKUs, we deliver the goods fast. So you can be more agile every minute, every day. This is who we are. This is what our new name means. Go ahead and expect excellence, because we're bringing it.

## Our Mission and Vision

To be the industry's preferred partner in surface preparation solutions through unrivaled technical expertise, customer experience, product availability, and tailored service offerings.



## The Allredi Difference



- **Industry Experience** – With Allredi on your team, you have access to expertise which can only come from decades of industry leadership. We have organized our engineering department, production specialists, customer operations, and safety support into a "Center of Competence." As an Allredi customer, you have access to hundreds of years of cumulative experience related to your operations.
- **Manufacturing Excellence** – Allredi is a U.S. based manufacturer of equipment for the Surface Preparation and Protective Coatings industries. Allredi's engineers benchmark the industry to ensure that we design and manufacture superior products that set the "Gold Standard" for performance, safety, and quality.
- **Legendary Customer Service** – Allredi's legendary customer service team is staffed by friendly, highly-trained individuals who are focused on providing the highest level of product support, order accuracy, and customer satisfaction.
- **Product Availability** – We stock over 10,000 SKU's and have over 45 shipping locations to serve North American and International markets for all major brands of blasting, coating, environmental, and safety equipment. Allredi is your right-now supplier, so you can keep your projects moving. From our foundation of strong relationships, we have built a nationwide network that puts vast inventory and ready service close to our customers. We provide advanced expertise, and we deliver the goods fast – so you can easily access the products and services you need to me more agile every minute, every day.
- **Technology Leadership** – Our website provides: Operator's Manuals, Part Numbers and Schematics Guides, SDS information, and key product features and specifications, providing access to information 24/7.

# TABLE OF CONTENTS







<b>Company Profile</b> .....	<b>2</b>
<b>Part Numbers</b> .....	<b>4</b>
Graco® FTx™ Airless Spray Guns .....	4
Tip Brushes .....	4
Tip Specification Summary .....	5
Tip Guard Summary .....	6
RAC® 5 Switchtip Specifications .....	7
RAC® X Fine Finish Switchtip™ Specifications .....	8
RAC® 5 Linelazer Switchtip™ Specifications .....	9
RAC® X Switchtip™ Specifications .....	10
Contractor™ Flat Tip Specifications .....	11
Fine Finish Flat Tip Specifications .....	12
Silver Flat Tip Specifications .....	13
Mesh Gun Filters .....	14
Tip Extensions .....	14
Tip Gaskets .....	15
Tip Filters .....	15
Tip Filter Housing .....	15
<b>Part Numbers And Schematics Guide</b> .....	<b>16</b>

## PART NUMBERS









		GRACO® FTx™ AIRLESS SPRAY GUNS			
Part Numbers		Trigger Style	Tip	Tip Guard	Maximum Working Pressure
	20G288429	2-Finger	RAC® X 515	RAC® X	3,600 psi
	20G288430	4-Finger	RAC® X 515	RAC® X	3,600 psi
	20G288431	4-Finger	RAC® 5 515	RAC® 5	3,600 psi

		TIP BRUSHES	
Part Numbers		Size	Bristle Material
	20G101891	3/8" x 2-1/4"	Nylon
	20G101892	5/8" x 2-1/4"	Nylon
	20G119799	3/8" x 1"	Nylon

# PART NUMBERS

		TIP SPECIFICATION SUMMARY				
Part Numbers	Tip Guard	Maximum Working Pressure	Color	Typical Applications	Typical Materials	
	RAC® 5 Switch Tip™ (20G286xxx)	RAC® 5 HandTite™ 20G243161 or 20G243263	4050 psi	Black	Residential, Commercial, or Industrial	Lacquers to Mastics, Latex Paints
	RAC® 5 SwitchTip™ LineLazer® (20GLL5xxx)	RAC® 5 HandTite™ 20G243161 or 20G243263	4050 psi	Yellow	Parking Lots, Roads, Warehouse Floors, Crosswalks, and Athletic Fields	Heavy Waterbase to thin Alkyd Traffic Paints
	RAC X™ Fine Finish Switch Tip™ (20GFFTxxx)	RAC X™ HandTite™ 20G246215	4050 psi	Green	Cabinetry, Woodworking, Metal and Fine Finish Surfaces	Lacquers, Varnishes, Urethanes
	RAC X™ Switch Tip™ (20GLTXxxx)	RAC X™ HandTite™ 20G246215 or 20G246437	4050 psi	Blue	Residential, Commercial, or Industrial	Lacquers to Mastics, Latex Paints
	Contractor Flat Tip (20G269xxx)	Flat 20G220255 or 20G220251	5000 psi	N/A	Residential, Commercial, or Industrial	Architectural Coatings
	Silver Flat Tip (20G163xxx)	Flat 20G220255 or 20G220251	5000 psi	N/A	Residential, Commercial, or Industrial	Dyes, Ink, Stains, Oils, Auto Finishes
	Fine Finish Flat Tip (20G163xxx)	Fine Finish 20G220249	4050 psi	N/A	Cabinetry, Woodworking, Metal and Fine Finish Surfaces	Lacquers, Varnishes, Urethanes, and other Fine Finish Materials

## PART NUMBERS

		TIP GUARD SUMMARY		
	Part Numbers	Tip Style	Thread Size	Color
	20G243161	RAC® 5 HandTite™	7/8"	Orange
	20G243263	RAC® 5 HandTite™	11/16"	Orange
	20G246215	RAC X™ HandTite™	7/8"	Blue
	20G246437	RAC X™ HandTite™	11/16"	Blue
	20G220251	Flat	7/8"	Orange
	20G220255	Flat	11/16"	Orange
	20G220247	Fine Finish Flat	7/8"	Orange
	20G220249	Fine Finish Flat	11/16"	Orange

# PART NUMBERS

		RAC® 5 SWITCHTIP SPECIFICATIONS				
Part Numbers		Tip Guard	Maximum Working Pressure	Color	Typical Applications	Typical Materials
	<b>RAC® 5 Switch Tip™ (20G286xxx)</b>	RAC® 5 HandTite™ 20G243161 or 20G243263	4050 psi	Black	Residential, Commercial, or Industrial	Lacquers to Mastics, Latex Paints

## RAC® 5 Switch Tip™ (20G286xxx)

		ORIFICE SIZE – INCHES																					
		.007	.009	.011	.013	.015	.017	.019	.021	.023	.025	.027	.029	.031	.033	.035	.039	.043	.045	.051	.055	.063	.065
FAN WIDTH	IN																						
	2-4		109	111	113	115		119	121														
	4-6	207	209	211	213	215	217	219	221	223	225					235							
	6-8	307	309	311	313	315	317	319	321	323	325	327		331									
	8-10		409	411	413	415	417	419	421	423	425	427	429		433	435	439	443		451	455		
	10-12		509	511	513	515	517	519	521	523	525	527	529	531	533	535		543		551	561	563	
	12-14		609	611	613	615	617	619	621	623	625	627	629	631	633	635		645		655			665
	14-16								721	723	725		729			735							
	16-18					815	817	819	821			827		831	833	835							
	18-20						917									935							
	Flow Rate (gpm)	.05	.09	.12	.18	.24	.31	.38	.47	.57	.67	.77	.90	1.03	1.17	1.31	1.63	1.98	2.17	2.79	3.25	4.26	4.53

## PART NUMBERS

### RAC® X FINE FINISH SWITCHTIP™ SPECIFICATIONS

	<b>Part Numbers</b>	<b>Tip Guard</b>	<b>Maximum Working Pressure</b>	<b>Color</b>	<b>Typical Applications</b>	<b>Typical Materials</b>
	<b>RAC X™ Fine Finish Switch Tip™ (20GFFTxxx)</b>	RAC X™ HandTite™ 20G246215	4050 psi	Green	Cabinetry, Woodworking, Metal and Fine Finish Surfaces	Lacquers, Varnishes, Urethanes

### RAC X™ Fine Finish Switch Tip™ (20GFFTxxx)

		ORIFICE SIZE – INCHES				
		IN	.008	.010	.012	.014
FAN WIDTH	2-4		108	110	112	
	4-6		208	210	212	214
	6-8		308	310	312	314
	8-10			410	412	414
	10-12			510	512	514
	12-14				612	614
	Flow Rate (gpm)		.07	.11	.15	.21



# PART NUMBERS

## RAC® 5 LINELAZER SWITCHTIP™ SPECIFICATIONS

	<b>Part Numbers</b>	<b>Tip Guard</b>	<b>Maximum Working Pressure</b>	<b>Color</b>	<b>Typical Applications</b>	<b>Typical Materials</b>
	<b>RAC® 5 Switch Tip™ LineLazer® (20GLL5xxx)</b>	RAC® 5 HandTite™ 20G243161 or 20G243263	4050 psi	Yellow	Parking Lots, Roads, Warehouse Floors, Crosswalks, and Athletic Fields	Heavy Waterbase to thin Alkyd Traffic Paints

### RAC® 5 LineLazer® Switch Tip™ (20GLL5xxx)

		ORIFICE SIZE – INCHES													
		.013	.015	.017	.019	.021	.023	.025	.027	.029	.031	.033	.035	.039	.055
FAN WIDTH	IN														
	2	213	215	217	219										
	4		315	317	319	321	323	325	327	329	331	333	335		355
	4-8			417	419	421	423	425	427	429	431		435		
	8-12					621	623	625	627	629	631		635	639	
	Flow Rate (gpm)	.18	.24	.31	.38	.47	.57	.67	.77	.90	1.03	1.17	1.31	1.63	3.25

# PART NUMBERS

## RAC® X SWITCHTIP™ SPECIFICATIONS

Part Numbers	Tip Guard	Maximum Working Pressure	Color	Typical Applications	Typical Materials
 <b>RAC X™ Switch Tip™ (20GLTXxxx)</b>	RAC® X HandTite™ 20G246215 or 20G246437	4050 psi	Blue	Residential, Commercial, or Industrial	Lacquers to Mastics, Latex Paints

### RAC X™ Switch Tip™ (20GLTXxxx)

		ORIFICE SIZE – INCHES													
		IN	.007	.009	.011	.013	.015	.017	.019	.021	.023	.025	.027	.029	.031
FAN WIDTH	2-4			109	111		115								
	4-6	207	209	211	213	215	217	219	221		225	227			231
	6-8		309	311	313	315	317	319	321	323	325	327	329	331	
	8-10		409	411	413	415	417	419	421	423	425	427	429	431	
	10-12		509	511	513	515	517	519	521	523	525	527	529	531	
	12-14			611	613	615	617	619	621	623	625	627	629	631	
	14-16								721	723			729		
	16-18						817	819	821			827		831	
	Flow Rate (gpm)		.05	.09	.12	.18	.24	.31	.38	.47	.57	.67	.77	.90	1.03

### RAC X™ Switch Tip™ (20GLTXxxx) continued

		ORIFICE SIZE – INCHES												
		IN	.033	.035	.037	.039	.041	.043	.045	.051	.055	.061	.065	.071
FAN WIDTH	2-4													
	4-6			235										
	6-8			335										
	8-10	433	435		439	441	443	445	451	455				
	10-12	533	535	537	539	541	543	545	551	555	561			
	12-14	633	635	637	639	641	643	645	651	655	661	665	671	
	14-16		735											
	16-18	833	835											
	Flow Rate (gpm)		1.17	1.31	1.47	1.63	1.8	1.98	2.17	2.79	3.25	4.0	4.53	5.41

# PART NUMBERS

## CONTRACTOR™ FLAT TIP SPECIFICATIONS

	<b>Part Numbers</b>	<b>Tip Guard</b>	<b>Maximum Working Pressure</b>	<b>Color</b>	<b>Typical Applications</b>	<b>Typical Materials</b>
	<b>Contractor Flat Tip (20G269xxx)</b>	Flat 20G220255 or 20G220251	5000 psi	N/A	Residential, Commercial, or Industrial	Architectural Coatings

### Contractor Flat Tips (20G269xxx)

		ORIFICE SIZE – INCHES												
		IN	.011	.013	.015	.017	.019	.021	.023	.025	.027	.029	.031	.035
FAN WIDTH	4-6	211	213	215	217	219			225	227				
	6-8	311	313	315	317	319	321	323	325	327				
	8-10	411	413	415	417	419	421	423	425	427				435
	10-12	511	513	515	517	519	521	523	525	527			531	
	12-14		613	615	617	619	621	623	625	627			631	635
	14-16			715	717	719	721		725					
	16-18			815		819	821			827	829	831		
	18-20								925					
	Flow Rate (gpm)		.12	.18	.24	.31	.38	.47	.57	.67	.74	.90	1.03	1.31

# PART NUMBERS

## FINE FINISH FLAT TIP SPECIFICATIONS

	<b>Part Numbers</b>	<b>Tip Guard</b>	<b>Maximum Working Pressure</b>	<b>Color</b>	<b>Typical Applications</b>	<b>Typical Materials</b>
	<b>Fine Finish Flat Tip (20G163xxx)</b>	Fine Finish 20G220249	4050 psi	N/A	Cabinetry, Woodworking, Metal and Fine Finish Surfaces	Lacquers, Varnishes, Urethanes, and other Fine Finish Materials

### Fine Finish Flat Tips (20G163xxx)

		ORIFICE SIZE – INCHES													
		IN	.008	.010	.021	.014	.016	.018	.020	.022	.024	.026	.028	.030	.032
FAN WIDTH	2-4	108	110												
	4-6	208	210	212	214	216	218				224				232
	6-8		310	312	314	316	318	320	322	324					
	8-10	408	410	412	414	416	418	420		424	426	428	430	432	
	10-12		510	512	514	516	518	520	522	524	526	528	530		
	12-14		610	612	614	616	618	620	622	624	626	628			
	14-16			712	714	716	718				726				
	16-18				814	816	818	820	822	824	826	828		832	
	18-20			912	914		918		922	924	926				
		Flow Rate (gpm)	.07	.11	.15	.21	.27	.35	.43	.52	.62	.73	.84	.97	1.1

# PART NUMBERS





## SILVER FLAT TIP SPECIFICATIONS





	<b>Part Numbers</b>	<b>Tip Guard</b>	<b>Maximum Working Pressure</b>	<b>Color</b>	<b>Typical Applications</b>	<b>Typical Materials</b>
	<b>Silver Flat Tip (20G163xxx)</b>	Flat 20G220255 or 20G220251	5000 psi	N/A	Residential, Commercial, or Industrial	Dyes, Ink, Stains, Oils, Auto Finishes

### Silver Fine Finish Flat Tips (20G163xxx)





		ORIFICE SIZE – INCHES												
		IN	.011	.013	.015	.017	.019	.021	.023	.025	.027	.029	.031	.035
FAN WIDTH	4-6		211	213	215	217	219			225	227			
	6-8		311	313	315	317	319	321	323	325	327			
	8-10		411	413	415	417	419	421	423	425	427			435
	10-12		511	513	515	517	519	521	523	525	527		531	
	12-14			613	615	617	619	621	623	625	627		631	635
	14-16				715	717	719	721		725				
	16-18				815		819	821			827	829	831	
	18-20									925				
	Flow Rate (gpm)		.12	.18	.24	.31	.38	.47	.57	.67	.74	.90	1.03	1.31



## PART NUMBERS

		MESH GUN FILTERS		
Part Numbers		Mesh Size	Color	Package Quantity
	20G287032	60 Mesh	Black	1/Package
	20G287033	100 Mesh	Blue	1/Package
	20G287034	60 Mesh and 100 Mesh	Black and Blue	1 Each/Package
	20G224455	100 Mesh	Silver	2/Package
	20G224456	50 Mesh	Silver	2/Package

		TIP EXTENSIONS	
Part Numbers		Description	Package Quantity
	20G246294	Heavy-Duty 10" Tip Extension	One Each
	20G246295	Heavy-Duty 15" Tip Extension	One Each
	20G246296	Heavy-Duty 18" Tip Extension	One Each
	20G246297	High Pressure 180° Swivel	One Each

## PART NUMBERS

		TIP GASKETS		
	Part Numbers	Description	Material	Package Quantity
	20G166969	1/16" Thin Tip Gasket	Nylon	One Each
	20G223373	1/16" Thin Tip Gaskets	Nylon	25
	20G162863	5/32" Thick Tip Gaskets	Nylon	One Each
	20G223374	5/32" Thick Tip Gaskets	Nylon	25

		TIP FILTERS	
	Part Numbers	Mesh Size	Package Quantity
	20G224453	60 Mesh	5/Package
	20G224454	100 Mesh	5/Package

		TIP FILTER HOUSING	
	Part Numbers	Description	Package Quantity
	20G164120	Tip Filter Housing	One Each

# PART NUMBERS AND SCHEMATICS GUIDE

## Graco® FTx™ Airless Spray Gun

Item#	Part#	Description
<b>Fig. 1</b>		
1	20G289914	Housing Assembly
5	20G287032	Filter, 60 Mesh
—	20G287033	Filter, 100 Mesh
—	20G287034	Filter, 60 and 100 Mesh Combo
6	20G120777	Packing, O-Ring
7	20G15J735	FTx™ Gun
8	20G288811	Swivel Assembly
9	20G120733	O-Ring, Urethane, Clear
10	20G15J706	Retainer, Guard, Trigger
11	20G15J698	Tube, Handle
12	20G120834	Screw, Set
13	20G15J769	Trigger, 4-Finger
14	20G117602	Screw, Shoulder Pan HD
15	20G288488	Kit, Needle Repair
15a	—	Needle Assembly
15b	—	Diffuser Assembly
16	20G15J696	Pin, trigger
17	20G105334	Nut, Lock Hex
19	20G15J464	Guard, Trigger
20	20G15J528	Guide, Spring
21	20G121093	Spring, Compression
22	20G15B549	Nut, End
31	20G119799	Brush, Cleaning
—	206M522	Part Numbers & Schematics Guide – Graco® FTx™ Airless Spray Guns
—	209V522	Operators Manual – Graco® FTx™ Airless Spray Guns

*\*Item not available for individual sale*



# PART NUMBERS AND SCHEMATICS GUIDE

Figure 1: Graco® FTx™ Airless Spray Gun

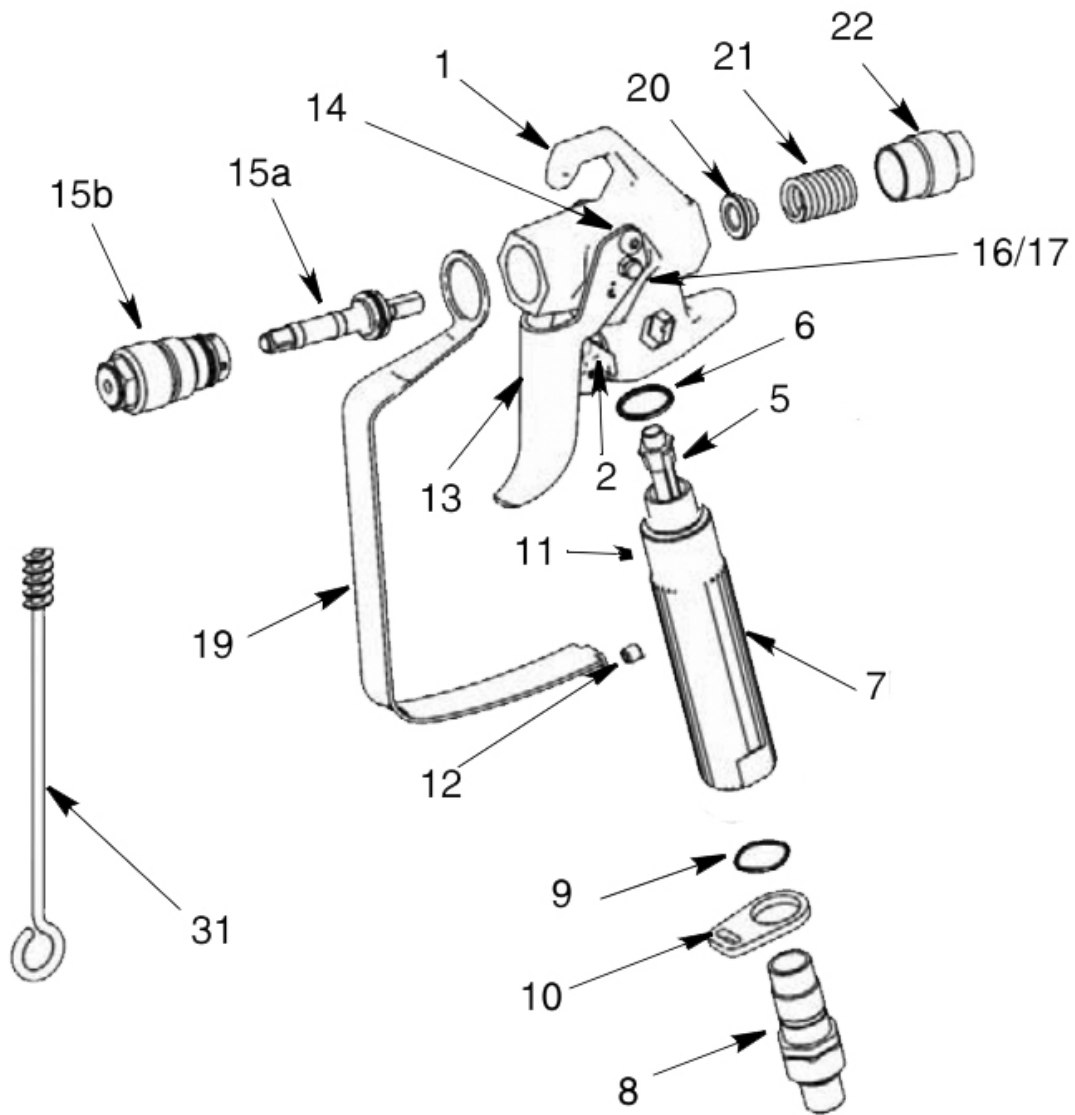





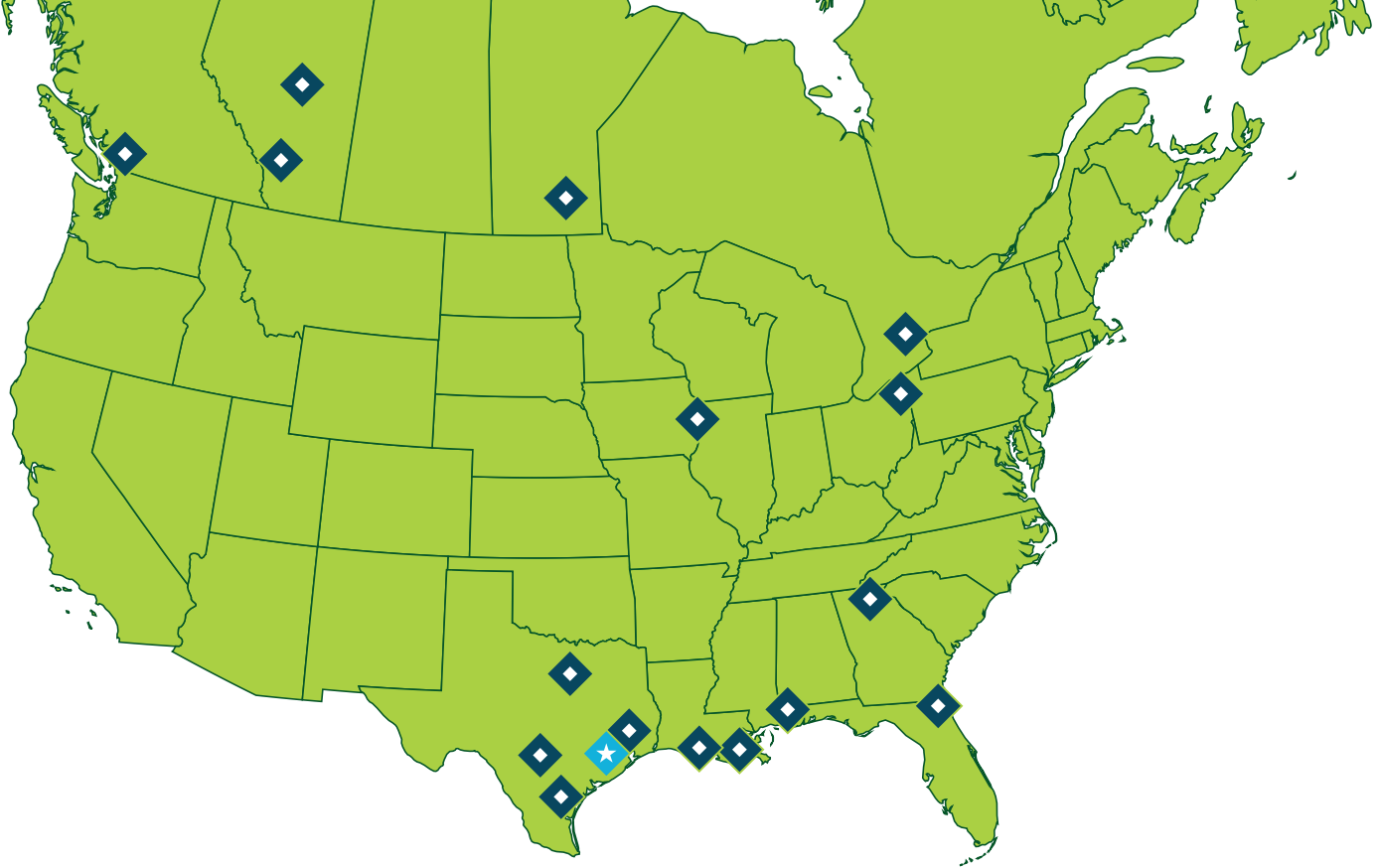

## ALLREDI THERE

Serving these industries: Bridge, Pipeline, Tank & Tower, Concrete Services, Rail, Shipyard & Marine, Pools & Fountains and Foundry

### UNITED STATES

#### Pasadena, TX (*Headquarters*)

844.361.7038

#### Beaumont, TX

409.722.1284

#### Bristol, PA

215.826.8080

#### Corpus Christi, TX

361.887.2038

#### Davenport, IA

563.324.2519

#### Deer Park, TX

(*Service & Rental Location*)

281.930.0905

#### Duluth, GA

800.535.4564

#### Gonzales, LA

225.647.7575

#### Harvey, LA

504.367.8090

#### Houma, LA

985.580.4273

#### Jacksonville, FL

904.262.2120

#### Lafayette, LA

337.267.1440

#### Theodore, AL

251.338.7525

#### Youngstown, OH

330.448.6267

### CANADA

#### Calgary, Alberta

403.279.1924

#### Coquitlam, BC

604.464.6979

#### Edmonton, Alberta

780.468.2588 (Manus)

780.425.5510 (Mod-U-Blast)

#### Hamilton, Ontario

905.527.6000 / 888.794.5665

#### Mississauga, Ontario

905.890.5837

#### Winnipeg, Manitoba

204.256.3324

**800-252-7848 / WWW.ALLREDI-US.COM**

Allredi™ and Marco® are registered trademarks of Allredi, LLC.

All other brand names or marks are used for identification purposes and are trademarks of their respective owners.

**ALLREDI**™

Literature #206M522\_8/24/22