



GRACO® FLEX PLUS™ AIRLESS SPRAY GUN



PART NUMBERS AND SCHEMATICS GUIDE

Company Profile

Since 1944, Marco has developed a strong tradition of providing innovative and reliable products and services to the surface preparation and protective coatings industries. We are the world's premier provider of Abrasives, Blasting Equipment, Coating Equipment, Engineered Systems, Rental Equipment, Safety Equipment, Service, and Repair.

Through innovative designs and a total commitment to quality, Marco manufactures products that increase production rates, create a safer workplace, and reduce maintenance costs. Marco's industry experience, manufacturing capabilities, legendary customer service, product availability, logistics services, and technology leadership is your assurance that we deliver high quality products and services, providing the best value to you, our customer.

The Marco Difference

- **Industry Experience** – With Marco on your team, you have access to expertise which can only come from decades of industry leadership. We have organized our engineering department, production specialists, customer operations, and safety support into a “Center of Competence.” As a Marco customer, you have access to hundreds of years of cumulative experience related to your operations.
- **Manufacturing Excellence** – Marco is a U.S. based, ISO 9001:2008 certified manufacturer of equipment for the Surface Preparation and Protective Coatings industries. Marco's engineers benchmark the industry to ensure that we design and manufacture superior products that set the “Gold Standard” for performance, safety, and quality.
- **Legendary Customer Service** – Marco's legendary customer service team is staffed by friendly, highly-trained individuals who are focused on providing the highest level of product support, order accuracy, and customer satisfaction.
- **Product Availability** – We stock over 10,000 SKU's and have over 45 shipping locations to serve North American and International markets for all major brands of blasting and painting equipment. As the largest provider of surface preparation and protective coatings equipment in the world, our inventory levels and product availability are unmatched.
- **Logistics Services** – Marco's in-house logistics team is dedicated to moving your shipment anywhere in the world. We move over 14,000 truckloads every year, allowing you to save on freight costs by leveraging our buying power. Lower your process costs with a single invoice, which includes product and freight.
- **Technology Leadership** – Our website provides: Operator's Manuals, Part Numbers and Schematics Guides, MSDS information, and Features and Specifications Guides, providing access to information 24/7. Our Extranet application allows you to receive quotes and place orders online. Our Intranet maintains a complete record of your purchase history to assist with ongoing support of your existing equipment and future purchasing decisions.

Vision Statement

Marco is the world's premier provider of Abrasives, Blasting Equipment, Coating Equipment, Engineered Systems, Rental Equipment, Safety Equipment, Service, and Repair.

Mission Statement

Marco provides strong leadership and innovation to the surface preparation and protective coatings industries. We dedicate our efforts to the continuous improvement of our products, services, processes, people, and most importantly, the quality of our customer's experience.

Quality Policy

Marco is committed to providing superior quality in the design, manufacturing, distribution, rental, service, and repair of our products. Our ISO 9001:2008 certification extends throughout all operations in all locations. Continuous improvement of our processes and supply chain Integration comprise the core of our business strategy for delivering exceptional quality and value in all Marco products and services.

Management Philosophy

We are a company dedicated to the success of every customer and associate. We discuss, debate, challenge, measure, and test our ideas. We will be boundless and limitless in our passion to improve. Through sound leadership and dedicated associates, we will ensure a long term, profitable future for Marco, our associates, customers, and suppliers.

TABLE OF CONTENTS

Company Profile	2
Table of Contents	3
Graco® Flex Plus™ Airless Spray Guns	4-9
Graco® Flex Plus™ Gun Part Numbers.....	4-5
Part Numbers and Schematics.....	6-7
Tip Specifications.....	8
Tip Guards.....	9
Graco® Tips Charts and Specifications	10-16
RAC® 5 Switch Tip™	10
RAC® 5 Switch Tip™ LineLazer®	11
RAC X™ Fine Finish Switch Tip™	12
RAC X™ Switch Tip™	13
RAC® XHD™ Switch Tip™	14
Fine Finish Flat Tip	15
Contractor Flat Tip	16
Optional Accessories	17-18
Tip Gaskets.....	17
OneSeal™	17
Solvent Seal Kits	17
Tip Filter Housing.....	18
Tip Filters.....	18
Tip Brushes.....	18
Maintenance Notes	19

PART NUMBERS AND SCHEMATICS GUIDE

GRACO® FLEX PLUS™ AIRLESS SPRAY GUNS				
Part Numbers	Maximum Working Pressure	Tip	Tip Guard	Trigger Style
20G246468	5,000 psi	RAC X™ 517 Switch Tip™	RAC X™ HandTite™	2-Finger
20G248157	5,000 psi	LineLazer® RAC® 5 Tip 319	RAC® 5 HandTite™	2-Finger
20G235458	5,000 psi	—	DripLess™ Tip Guard	2-Finger

PART NUMBERS AND SCHEMATICS GUIDE



PART NUMBERS AND SCHEMATICS GUIDE

Graco® Flex Plus™ Airless Spray Gun





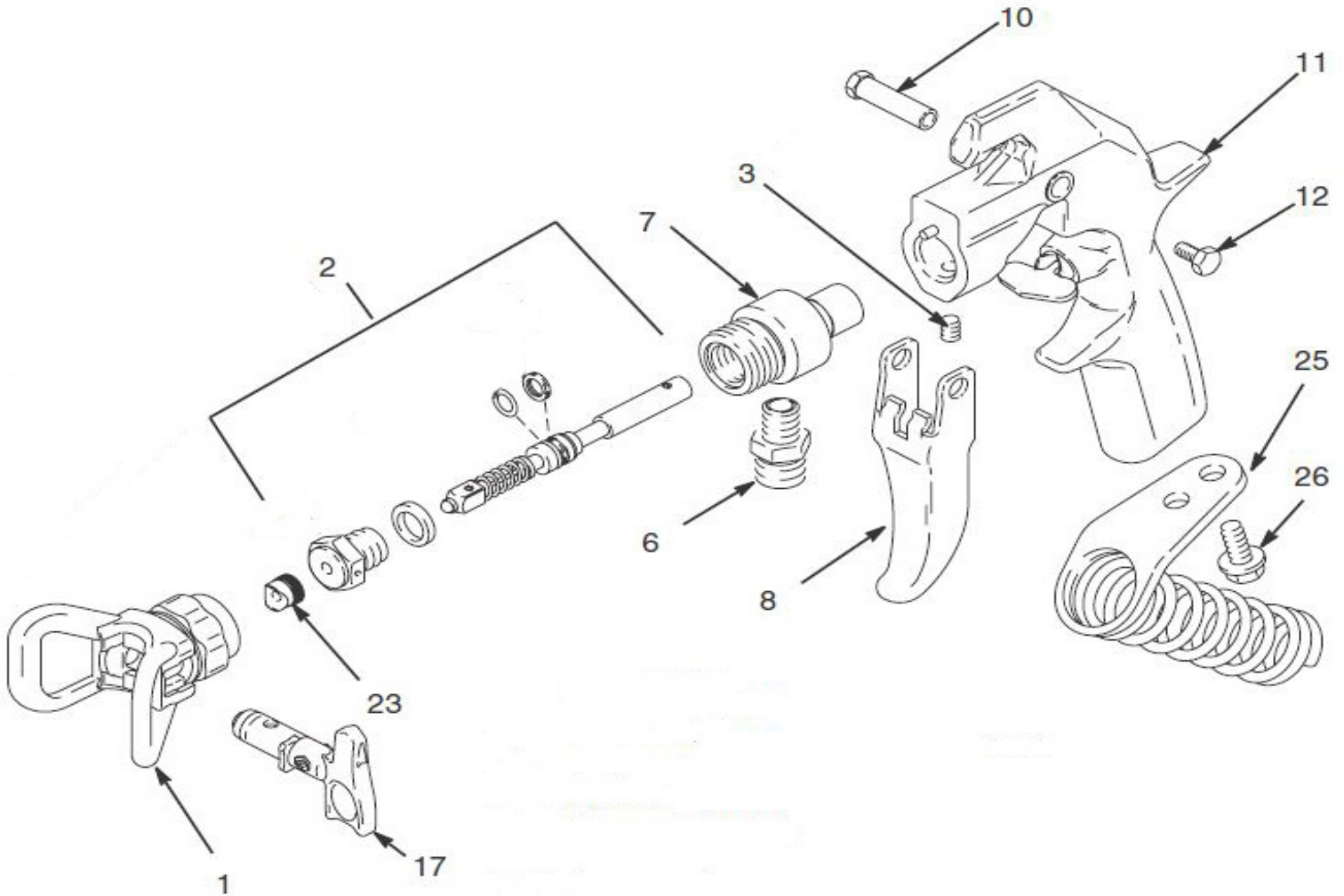

Item#	Part#	Description
Fig. 1		
1	20G220251	Flat Tip Guard (For use with 20G235458)
—	20G243263	HandTite™ Tip Guard, RAC® 5 (For use with 20G248157)
—	20G246215	HandTite™ Tip Guard, RAC X™ (For use with 20G246468)
2	20G235474	Needle Kit
3	20G102207	Setscrew 1/4-20
6	20G191872	1/4" x 1/8" Nipple
7	20G187972	Fluid Housing
8	20G187985	2-Finger Trigger
10	20G187965	Pivot Pin
11	20G235471	Gun Handle
12	20G203953	Screw Hex Washer HD
17	—	Spray Tip (<i>See Tip Specification Summary</i>)
23	—	(<i>See Optional Accessories</i>)
25	20G218139	Hose Holder
26	20G107257	Cap Screw
—	206M561	Part Numbers & Schematics Guide – Graco® Flex Plus™ Airless Spray Guns
—	209V561	Operator Manual – Graco® Flex Plus™ Airless Spray Guns
—	201V110	Graco® Airless Accessories – Brochure

PART NUMBERS AND SCHEMATICS GUIDE











Figure 1: Graco® Flex Plus™ Airless Spray Gun



PART NUMBERS AND SCHEMATICS GUIDE

	Part Numbers	TIP SPECIFICATION SUMMARY				
		Tip Guard	Typical Applications	Typical Materials	Maximum Working Pressure	Color
	RAC® 5 Switch Tip™ (20G286xxx)	RAC® 5 HandTite™ 20G243161 or 20G243263	Residential, Commercial, or Industrial	Lacquers to Mastics, Latex Paints	4050 psi	Black
	RAC® 5 Switch Tip™ LineLazer® (20GLL5xxx)	RAC® 5 HandTite™ 20G243161 or 20G243263	Parking Lots, Roads, Warehouse Floors, Crosswalks, and Athletic Fields	Heavy Water-base to thin Alkyd Traffic Paints	4050 psi	Yellow
	RAC X™ Fine Finish Switch Tip™ (20GFFTxxx)	RAC X™ HandTite™ 20G246215 or 20G246237	Cabinetry, Woodworking, Metal and Fine Finish Surfaces	Lacquers, Varnishes, Urethanes	4050 psi	Green
	RAC X™ Switch Tip™ (20GLTXxxx)	RAC X™ HandTite™ 20G246215 or 20G246437	Residential, Commercial, or Industrial	Lacquers to Mastics, Latex Paints	4050 psi	Blue
	XHD™ RAC® Switch Tip™ (20GXHDxxx)	XHD™ RAC® 20GXHD001, 20GXHD003, or 20GXHD005	Bridges, Tanks, Farms, Structural Steel, or Roofing	Virtually all Paints and Coatings – Solvent and Water-base	7250 psi	Gray
	Fine Finish Flat Tip (20G163xxx)	Fine Finish 20G220249	Cabinetry, Woodworking, Metal and Fine Finish Surfaces	Lacquers, Varnishes, Urethanes, and other Fine Finish Materials	4050 psi	N/A
	Contractor Flat Tip (20G269xxx)	Flat 20G220255 or 20G220251	Residential, Commercial, or Industrial	Architectural Coatings	5000 psi	N/A

PART NUMBERS AND SCHEMATICS GUIDE

		TIP GUARD SUMMARY		
	Part Numbers	Tip Style	Thread Size	Color
	20G243161	RAC® 5	7/8"	Orange
	20G243263	RAC® 5	11/16"	Orange
	20G246215	RAC X™	7/8"	Blue
	20G246437	RAC X™	11/16"	Blue
	20GXHD001	XHD™ RAC®	7/8"	Gray
	20GXHD003	XHD™ RAC®	7/8" (Stainless Steel)	Gray
	20GXHD005	XHD™ RAC®	11/16"	Gray
	20G220247	Fine Finish Flat	7/8"	Orange
	20G220249	Fine Finish Flat	11/16"	Orange
	20G220251	Flat	7/8"	Orange
	20G220255	Flat	11/16"	Orange

PART NUMBERS AND SCHEMATICS GUIDE

RAC® 5 SWITCH TIP™ SPECIFICATIONS

	Part Numbers	RAC® 5 SWITCH TIP™ SPECIFICATIONS				
		Color	Maximum Working Pressure	Tip Guard	Typical Applications	Typical Materials
	RAC® 5 Switch Tip™ (20G286xxx)	Black	4050 psi	RAC® 5 HandTite™ 20G243161 or 20G243263	Residential, Commercial, or Industrial	Lacquers to Mastics, Latex Paints

RAC® 5 Switch Tip™ (20G286xxx)

		ORIFICE SIZE – INCHES																					
		.007	.009	.011	.013	.015	.017	.019	.021	.023	.025	.027	.029	.031	.033	.035	.039	.043	.045	.051	.055	.063	.065
FAN WIDTH	IN																						
	2-4		109	111	113	115		119	121														
	4-6	207	209	211	213	215	217	219	221	223	225					235							
	6-8	307	309	311	313	315	317	319	321	323	325	327		331									
	8-10		409	411	413	415	417	419	421	423	425	427	429		433	435	439	443		451	455		
	10-12		509	511	513	515	517	519	521	523	525	527	529	531	533	535		543		551	561	563	
	12-14		609	611	613	615	617	619	621	623	625	627	629	631	633	635			645		655		665
	14-16									721	723	725		729		735							
	16-18					815	817	819	821				827		831	833	835						
	18-20						917									935							
	Flow Rate (gpm)	.05	.09	.12	.18	.24	.31	.38	.47	.57	.67	.77	.90	1.03	1.17	1.31	1.63	1.98	2.17	2.79	3.25	4.26	4.53

PART NUMBERS AND SCHEMATICS GUIDE

		RAC® 5 SWITCH TIP™ LINELAZER® SPECIFICATIONS				
Part Numbers		Color	Maximum Working Pressure	Tip Guard	Typical Applications	Typical Materials
	RAC® 5 LineLazer® Switch Tip™ (20GLL5xxx)	Yellow	4050 psi	RAC® 5 HandTite™ 20G243161 or 20G243263	Parking Lots, Roads, Warehouse Floors, Crosswalks, and Athletic Fields	Heavy Water-base to thin Alkyd Traffic Paints

RAC® 5 LineLazer® Switch Tip™ (20GLL5xxx)

		ORIFICE SIZE – INCHES													
IN		.013	.015	.017	.019	.021	.023	.025	.027	.029	.031	.033	.035	.039	.055
FAN WIDTH	2	213	215	217	219										
	4		315	317	319	321	323	325	327	329	331	333	335		355
	4-8			417	419	421	423	425	427	429	431		435		
	8-12					621	623	625	627	629	631		635	639	
	Flow Rate (gpm)	.18	.24	.31	.38	.47	.57	.67	.77	.90	1.03	1.17	1.31	1.63	3.25

PART NUMBERS AND SCHEMATICS GUIDE

RAC X™ FINE FINISH SWITCH TIP™ SPECIFICATIONS						
Part Numbers	Color	Maximum Working Pressure	Tip Guard	Typical Applications	Typical Materials	
	RAC X™ Fine Finish Switch Tip™ (20GFFTxxx)	Green	4050 psi	RAC X™ HandTite™ 20G246215 or 20G246237	Cabinetry, Woodworking, Metal and Fine Finish Surfaces	Lacquers, Varnishes, Urethanes

RAC X™ Fine Finish Switch Tip™ (20GFFTxxx)

		ORIFICE SIZE – INCHES			
		.008	.010	.012	.014
FAN WIDTH	IN				
	2-4	108	110	112	
	4-6	208	210	212	214
	6-8	308	310	312	314
	8-10		410	412	414
	10-12		510	512	514
	12-14			612	614
	Flow Rate (gpm)	.07	.11	.15	.21

PART NUMBERS AND SCHEMATICS GUIDE

RAC X™ SWITCH TIP™ SPECIFICATIONS

	Part Numbers	Color	Maximum Working Pressure	Tip Guard	Typical Applications	Typical Materials

RAC X™ Switch Tip™ (20GLTXxxx)

		ORIFICE SIZE – INCHES													
		IN	.007	.009	.011	.013	.015	.017	.019	.021	.023	.025	.027	.029	.031
FAN WIDTH	2-4			109	111		115								
	4-6		207	209	211	213	215	217	219	221		225	227		231
	6-8			309	311	313	315	317	319	321	323	325	327	329	331
	8-10			409	411	413	415	417	419	421	423	425	427	429	431
	10-12			509	511	513	515	517	519	521	523	525	527	529	531
	12-14				611	613	615	617	619	621	623	625	627	629	631
	14-16									721	723			729	
	16-18							817	819	821			827		831
	Flow Rate (gpm)		.05	.09	.12	.18	.24	.31	.38	.47	.57	.67	.77	.90	1.03

RAC X™ Switch Tip™ (20GLTXxxx) continued

		ORIFICE SIZE – INCHES												
		IN	.033	.035	.037	.039	.041	.043	.045	.051	.055	.061	.065	.071
FAN WIDTH	2-4													
	4-6			235										
	6-8			335										
	8-10		433	435		439	441	443	445	451	455			
	10-12		533	535	537	539	541	543	545	551	555	561		
	12-14		633	635	637	639	641	643	645	651	655	661	665	671
	14-16			735										
	16-18		833	835										
	Flow Rate (gpm)		1.17	1.31	1.47	1.63	1.8	1.98	2.17	2.79	3.25	4.0	4.53	5.41

PART NUMBERS AND SCHEMATICS GUIDE

RAC® XHD™ SWITCH TIP™ SPECIFICATIONS						
Part Numbers	Color	Maximum Working Pressure	Tip Guard	Typical Applications	Typical Materials	
 RAC® XHD™ Switch Tip™ (20GXHDxxx)	Gray	7250 psi	RAC® XHD™ 20GXHD001, 20GXHD003, or 20GXHD005	Bridges, Tanks, Farms, Structural Steel, or Roofing	Virtually all Paints and Coatings – Solvent and Water-base	

RAC® XHD™ Switch Tip™ (20GXHDxxx)

		ORIFICE SIZE – INCHES																	
FAN WIDTH	IN	.007	.009	.011	.013	.015	.017	.019	.021	.023	.025	.027	.029	.031	.033	.035	.037	.039	.041
	2-4	107	109	111	113	115	117	119	121									139	
	4-6		209	211	213	215	217	219	221		225	227	229	231		235		239	
	6-8	307	309	311	313	315	317	319	321	323	325	327	329	331	333	335	337	339	341
	8-10		409	411	413	415	417	419	421	423	425	427	429	431	433	435	437	439	441
	10-12		509	511	513	515	517	519	521	523	525	527	529	531	533	535	537	539	541
	12-14		609	611	613	615	617	619	621	623	625	627	629	631	633	635	637	639	641
	14-16			711	713	715	717	719	721	723	725	727	729	731	733	735	737	739	741
	16-18				813	815	817	819	821	823	825	827	829	831	833	835	837	839	841
	18-20									923		927		931	933	935	937	939	
	Flow Rate (gpm)	.05	.09	.12	.18	.24	.31	.38	.47	.57	.67	.77	.90	1.03	1.17	1.31	1.47	1.63	1.8

RAC® XHD™ Switch Tip™ (20GXHDxxx) continued

		ORIFICE SIZE – INCHES																	
FAN WIDTH	IN	.043	.045	.047	.047	.051	.053	.055	.057	.059	.061	.063	.065	.067	.069	.071	.075	.081	
	2-4																		
	4-6																		
	6-8	343	345	347		351		355											
	8-10	443	445	447	449	451		455		459	461	463	465	467		471	475	481	
	10-12	543	545	547	549	551	553	555	557		561		565	567		571	575		
	12-14	643	645	647	649	651		655	657	659	661	663	665	667	669	671	675		
	14-16	743		747	749	751	753	755			761			767		771			
	16-18	843		847		851		855			861	863		867					
	18-20																		
	Flow Rate (gpm)	1.98	2.17	2.37	2.58	2.79	3.05	3.25	3.49	3.74	4.0	4.26	4.53	4.82	5.11	5.41	6.04	7.04	

PART NUMBERS AND SCHEMATICS GUIDE

		FINE FINISH FLAT TIP SPECIFICATIONS				
Part Numbers		Color	Maximum Working Pressure	Tip Guard	Typical Applications	Typical Materials
	Fine Finish Flat Tip (20G163xxx)	N/A	4050 psi	Fine Finish 20G220249	Cabinetry, Woodworking, Metal and Fine Finish Surfaces	Lacquers, Varnishes, Urethanes, and other Fine Finish Materials

Fine Finish Flat Tips (20G163xxx)

		ORIFICE SIZE – INCHES												
IN		.008	.010	.021	.014	.016	.018	.020	.022	.024	.026	.028	.030	.032
FAN WIDTH	2-4	108	110											
	4-6	208	210	212	214	216	218			224				232
	6-8		310	312	314	316	318	320	322	324				
	8-10	408	410	412	414	416	418	420		424	426	428	430	432
	10-12		510	512	514	516	518	520	522	524	526	528	530	
	12-14		610	612	614	616	618	620	622	624	626	628		
	14-16			712	714	716	718				726			
	16-18				814	816	818	820	822	824	826	828		832
	18-20			912	914		918		922	924	926			
	Flow Rate (gpm)		.07	.11	.15	.21	.27	.35	.43	.52	.62	.73	.84	.97





PART NUMBERS AND SCHEMATICS GUIDE



		CONTRACTOR FLAT TIP SPECIFICATIONS				
Part Numbers		Color	Maximum Working Pressure	Tip Guard	Typical Applications	Typical Materials
	Contractor Flat Tip (20G269xxx)	N/A	5000 psi	Flat 20G220255 or 20G220251	Residential, Commercial, or Industrial	Architectural Coatings



Contractor Flat Tips (20G269xxx)

		ORIFICE SIZE – INCHES											
		.011	.013	.015	.017	.019	.021	.023	.025	.027	.029	.031	.035
FAN WIDTH	IN												
	4-6	211	213	215	217	219			225	227			
	6-8	311	313	315	317	319	321	323	325	327			
	8-10	411	413	415	417	419	421	423	425	427			435
	10-12	511	513	515	517	519	521	523	525	527		531	
	12-14		613	615	617	619	621	623	625	627		631	635
	14-16			715	717	719	721		725				
	16-18			815		819	821			827	829	831	
	18-20								925				
Flow Rate (gpm)		.12	.18	.24	.31	.38	.47	.57	.67	.74	.90	1.03	1.31

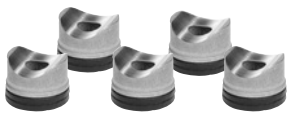
OPTIONAL ACCESSORIES

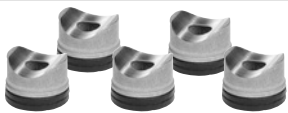

		TIP GASKETS		
	Part Numbers	Description	Material	Package Quantity
	20G166969	1/16" Thin Tip Gasket	Nylon	One Each
	20G223373	1/16" Thin Tip Gaskets	Nylon	25
	20G162863	5/32" Thick Tip Gaskets	Nylon	One Each
	20G223374	5/32" Thick Tip Gaskets	Nylon	25



		ONESEAL™		
	Part Numbers	Description		Package Quantity
	20G243281	RAC® 5 OneSeal™		Five
	20G246453	RAC X™ OneSeal™		Five

		SOLVENT SEAL KITS		
	Part Numbers	Description		Package Quantity
	20G224081	RAC® 5 Solvent Seal Kit		Five
	20G248936	RAC X™ Solvent Seal Kit		Five

OPTIONAL ACCESSORIES

TIP FILTER HOUSING			
	Part Numbers	Description	Package Quantity
	20G164120	Tip Filter Housing	One Each

TIP FILTERS			
	Part Numbers	Mesh Size	Package Quantity
	20G224454	60 Mesh	Five
	20G224453	100 Mesh	Five

TIP BRUSHES			
	Part Numbers	Size	Bristle Material
	20G101891	3/8" x 2-1/4"	Nylon
	20G101892	5/8" x 2-1/4"	Nylon
	20G119799	3/8" x 1"	Nylon

MAINTENANCE NOTES

DATE	TYPE OF SERVICE	PART NUMBER

GLOBAL HEADQUARTERS

- 3425 East Locust Street
Davenport, IA 52803

ph: 800.BLAST.IT (800.252.7848)

ph: 563.324.2519

fax: 563.324.6258

GULF STATES HEADQUARTERS

- 701 East Boulevard
Deer Park, TX 77536

ph: 800.BLAST.IT (800.252.7848)

ph: 281.930.0905

fax: 281.542.0736

REGIONAL BRANCH OFFICES

- **Iowa**
Davenport
- **Louisiana**
Gonzales
Lafayette
- **Ohio**
Youngstown
- **Texas**
Beaumont
Corpus Christi
Deer Park



ABRASIVES

BLASTING

COATING

DUST COLLECTORS

ENGINEERED SYSTEMS

RENTAL

SAFETY

SERVICE & REPAIR

VACUUMS

40+ NATIONWIDE SHIPPING LOCATIONS



★ Marco Regional Branch Offices
and Shipping Locations

● Direct Shipping Locations

CONTACT MARCO

800.BLAST.IT

(800.252.7848)

563.324.2519

FAX: 563.324.6258

WWW.MARCO.US

SALES@MARCO.US