

83C PRESSURE TANK Small Tank - Up To 2.8 Gallons

IMPORTANT: Read and follow all instructions and SAFETY PRECAUTIONS before using this equipment. Retain for future reference.

CA PROP
65

PROP 65 WARNING

WARNING: This product contains chemicals known to the State of California to cause cancer and birth defects or other reproductive harm.

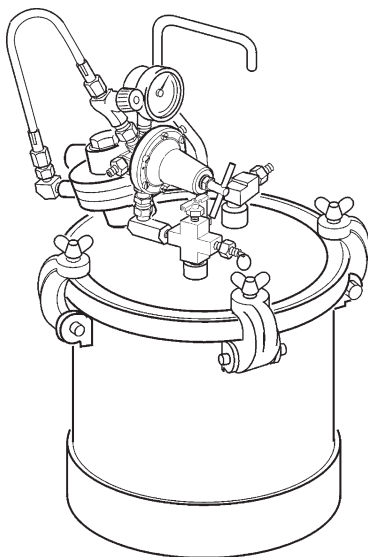

DESCRIPTION

The 83C pressure tanks are designed as a pressure container to supply liquid material at a constant preset pressure up to a maximum of 80 PSI. All models a polyethylene liner and are for light to medium duty use only.

Models:

83C-210: Single regulation (fluid), air inlet/outlet, fluid outlet, safety valve

83C-220: Dual regulation (air and fluid), otherwise same as 83C-210

83C-211: Single regulation (fluid), air driven agitator assembly, fluid outlet, safety valve

83C-221: Dual regulation (air and fluid), otherwise same as 83C-211

WARNING

Halogenated hydrocarbon solvents - for example: 1,1,1, - trichloroethane and methylene chloride - can chemically react with aluminum parts and components and cause an explosion hazard. These solvents will also corrode the galvanized tank coating. Read the label or data sheet for the material. Do not use materials containing these solvents with these pressure tanks.

CAUTION

Refer to specifications chart to ensure that fluids and solvents being used are chemically compatible with the tank wetted parts. Before placing fluids or solvents in tank, always read accompanying manufacturer's literature.

WARNING

Air pressure loads that are higher than design loads, or changes to the pressure feed tank can cause the tank to rupture or explode.

- A safety valve protects the tank from over pressurization. During each use pull the ring on the safety valve to make sure it operates freely and relieves air pressure. If the valve is stuck, does not operate freely, or does not relieve air pressure, it must be replaced. Do not eliminate, make adjustments or substitutions to this valve.

- Changes to the air tank will weaken it. Never drill into, weld or change the tank in any way.

- The maximum working pressure of this tank is 80 psi.

WARNING

Static electricity is created by the flow of fluid through the pressure tank and hose. If all parts are not properly grounded, sparking may occur. Sparks can ignite vapors from solvents and the fluid being sprayed.

If static sparking, or slight shock, is experienced while using this equipment, stop spraying immediately.

Ground the pressure tank by connecting one end of a 12 gauge minimum ground wire to the pressure tank and the other end to a true earth ground. Local codes may have additional grounding requirements.

See illustration, page 4, for grounding and grounding hardware required.

WARNING

Pressure Relief Procedure

High pressure can cause a serious injury. Pressure is maintained in a pressure tank after the system has been shut down. Before attempting removal of fill plug or cover, pressure must be relieved using the following steps:

1. Turn off the main air supply to the tank.
2. Shut off regulator or remove air supply line from tank.
3. Bleed off air in the tank by turning the air relief valve thumb screw counterclockwise. Wait until all the air has escaped through the valve before removing the pressure tank cover or fill plug.
4. Leave the air relief valve open until you have reinstalled the cover or fill plug.

SAFETY PRECAUTIONS

This manual contains information that is important for you to know and understand. This information relates to USER SAFETY and PREVENTING EQUIPMENT PROBLEMS. To help you recognize this information, we use the following symbols. Please pay particular attention to these sections.



Important information that tells how to prevent damage to equipment, or how to avoid a situation that may cause minor injury.







Important safety information – A hazard that may cause serious injury or loss of life.

Note

Information that you should pay special attention to.



The following hazards may occur during the normal use of this equipment. Please read the following chart.

HAZARD	CAUSE	SAFEGUARDS
<p>Fire</p> 	<p>Solvents and coatings can be highly flammable or combustible, especially when sprayed.</p>	<ol style="list-style-type: none"> 1. Adequate exhaust must be provided to keep the air free of accumulations of flammable vapors. 2. Smoking must never be allowed in the spray area. 3. Fire extinguishing equipment must be present in the spray area.
<p>Fire - Pressure Tank</p> 	<p>Vapors from flammable liquids can catch fire or explode.</p>	<ol style="list-style-type: none"> 1. Keep tank at least 10 feet away from sources of ignition. Ignition sources include hot objects, mechanical sparks, and arcing (non-explosion proof) electrical equipment.
<p>Inhaling Toxic Substances</p> 	<p>Certain materials may be harmful if inhaled, or if there is contact with the skin.</p>	<ol style="list-style-type: none"> 1. Follow the requirements of the Material Safety Data Sheet supplied by your coating material manufacturer. 2. Adequate exhaust must be provided to keep the air free of accumulations of toxic materials. 3. Use a mask or respirator whenever there is a chance of inhaling sprayed materials. The mask must be compatible with the material being sprayed and its concentration. Equipment must be as prescribed by an industrial hygienist or safety expert, and be NIOSH approved.
<p>Explosion, Pressure Tank - Rupture</p> 	<p>Making changes to pressure tank will weaken it.</p>	<ol style="list-style-type: none"> 1. Never drill into, weld, or modify tank in any way. 2. Do not adjust, remove, or tamper with the safety valve. If replacement is necessary, use the same type and rating of valve.
<p>General Safety</p>	<p>Improper operation or maintenance may create a hazard.</p>	<p>Operators should be given adequate training in the safe use and maintenance of the equipment (in accordance with the requirements of NFPA-33, Chapter 15 in U.S.). Users must comply with all local and national codes of practice and insurance company requirements governing ventilation, fire precautions, operation, maintenance and housekeeping (in the U.S., these are OSHA Sections 1910.94 and 1910.107, and NFPA-33).</p>

SPECIFICATIONS

Tank Size:	2.8 gal.
Height:	9-9/16", (10-1/2" to top of lid)
Maximum Working Pressure (MWP):	80 psi
Air Motor Consumption:	3-6 CFM at 60 psi
Maximum Agitator Air Inlet Pressure:	100 psi
Air Inlet Size:	1/4" NPS (M)
Fluid Outlet Size:	3/8" NPS (M)
Tank Net Weight:	
83C-210	28-1/4 lbs.
83C-220	29-3/4 lbs.
83C-211	32-3/4 lbs.
83C-221	34-1/4 lbs.

MATERIALS OF CONSTRUCTION

Zinc plated carbon steel tank, lid, fluid tube, lid bushing and outlet elbow fitting. Agitator shaft (agitated models); molded nylon propeller (agitated models); polyethylene liner.

PT-418 AIR MOTOR DRIVEN AGITATOR

The agitator utilizes an air driven motor to turn the agitator shaft to which a propeller is attached. The rotation of the propeller mixes materials which have a tendency to separate or settle quickly. Material agitation may be performed at the same time material is being sprayed without any adverse effect. The air motor is powerful and smooth running. An air adjusting valve is included to control the speed of the agitator. The air motor requires low air consumption, approximately 3-6 C.F.M. at 60 P.S.I. (Max. input air pressure 100 P.S.I.)

INSTALLATION

Mix and prepare material to be used according to manufacturer's instructions. Strain material through a fine mesh screen (60 or 90 mesh) to remove all foreign matter which is likely to enter and clog material passages.

1. Always relieve all air pressure in the tank. Turn thumbscrew on air pressure relief valve. Wait until pressure bleeds down.
2. Loosen thumb screws, tip lid clamps back and remove lid assembly.
3. Pour material into the tank. See accessories for strainers and disposable tank liners. A one gallon container may also be used by cutting 3/16" off end of fluid tube at an angle.
4. Replace the lid assembly and tighten clamps and thumb screws securely.
5. If possible, the air supply line should pass through an air filter/regulator to filter dirt from air and remove entrained water and oil. See **Accessories** for filters available. Connect the air supply hose to the air inlet fitting on tank regulator.
6. Connect the atomization air hose to the air outlet fitting which is directly opposite air inlet fitting.
7. Connect material hose to the fluid outlet fitting.
8. See Figure 1 for a typical hookup.

Figure 1

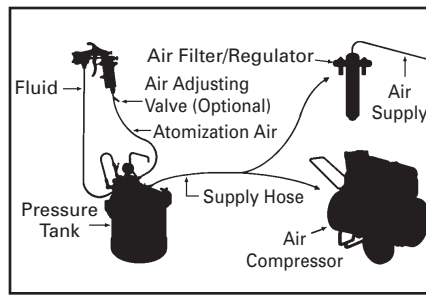

OPERATION

1. Turn on the air supply.
2. Turn T-Handle adjusting screw clockwise on the tank regulator to increase material pressure: turn it counter clockwise to decrease pressure. Maximum tank pressure is 80 PSI.
3. For tank with air motor agitator, turn the knob of the air adjusting valve (8) counterclockwise to set the desired agitator speed. Operate the agitator at the minimum speed required to keep the material thoroughly mixed. Do not over-agitate the material, causing a poor finish.
4. Atomization air for the spray gun can be adjusted at the gun by means of an air adjusting valve or, with the additional air regulator provided with "dual regulation" tank models (83C-220 or 83C-221).
5. See Spray Gun instructions for operation of the gun.

CAUTION

If using an air quick disconnect (Q.D.) at the inlet to the regulator at the pressure tank, do not disconnect the Q.D. while the tank is pressurized. Doing so will allow tank pressure to quickly relieve, and can potentially pull paint back through the air regulator and air motor, depending upon the liquid level in the tank. Tank pressure should always be relieved by turning the regulator fully counterclockwise or turning thumb screw on air relief valve.

REPLACEMENT OF PARTS (Air Motor Assembly, See Page 5)

Do not pry front plate (40) or end plate (46) from air motor body (43) with a screwdriver; this will dent the surface of the plates and body causing leaks. A puller tool should be used to remove the plate from the motor body while maintaining the position of the shaft. Holes must be drilled for dowel pins (42) after assembling front plate (40) on new body (43) for alignment of parts. Always install new end plate gaskets (41) when reassembling air motor.

**TO PREVENT SHIPPING DAMAGE,
AIR REGULATORS ARE SHIPPED
UNASSEMBLED; SOME ASSEMBLY
IS REQUIRED**

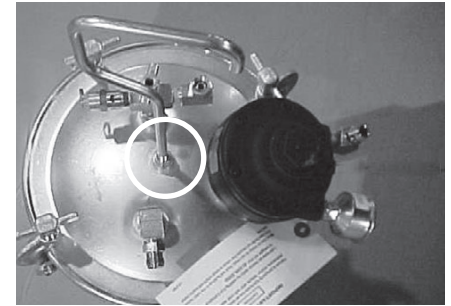

Assemble handle into tank and secure with a 9/16 wrench.

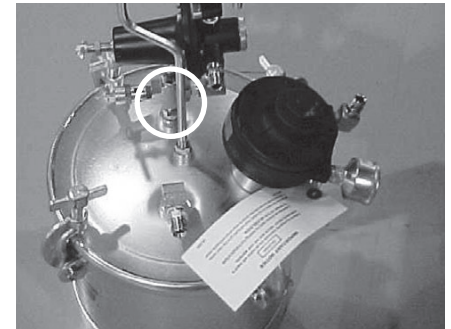

Assemble either single or double regulator to manifold with 11/16 wrench.

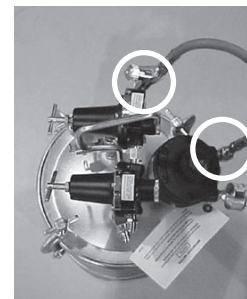

Assemble valve end of hose assembly to regulator using a 5/8 wrench. Assemble other end of hose to air motor with same wrench.

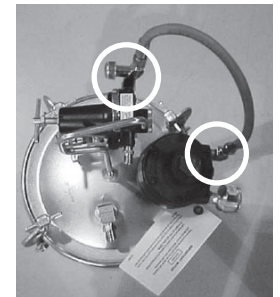

Ref. No.	Replacement Part No.	Description	Individual Parts Req.
1	PT-423	Tank Assy. Kit (Includes Ref. Nos. 1A, 18, 19, 20 & 21)	1
1A	PT-420	Tank Shell	1
2	PT-33-1	Lid Gasket, Santoprene	1
3	PT-425	Lid, Zinc Plated (Agitator)	1
4	PT-418	Air Motor/Adapter Assy. (See Pg. 5 for Breakdown)	1
*5	----	Street Elbow 1/4" NPT (F) x 1/4" NPT (M)	1
6	H-2008	Nipple 1/4" NPT(M) (83C-210 & 83C-220) x 1/4"NPS(M) (83C-211 & 83C-221)	2
7	HA-57011	Hose Assembly	1
8	HAV-500	Air Adjusting Valve 1/4" NPS (F) x 1/4" NPS (M)	1
9	83-2727	Gauge (83C-210, 83C-211)	1
		Gauge (83C-220, 83C-221)	2
*9A	----	Pipe Plug 1/4" NPT(M)(Supplied/Reg)	1
10	HAR-511	Regulator (All regulated models)	1
10A	HAR-507	Regulator (83C-220 & 83C-221)	1
11	SSP-30-ZN	90° Swivel Adapter 1/4" NPS (F) x 1/4" NPT (M)	1
*12	----	Cross 1/4" NPT (F)	1
13	TIA-4080	Safety Valve - 80 PSI	1
14	PT-32	Handle	1
*15	----	Hex Nut 3/8"-16	1
16	AD-11	Nipple 3/8" NPT (M) x 3/8" NPT (M) S.S.	1
*17	SSP-1939	Street Elbow 3/8" NPT (F) x 3/8" NPT (M) S.S.	1
18	----	Thumb Screw	4
19	----	Yoke Assembly	4
20	----	Cotter Pin, 3/32 x 1"	4
21	----	Hinge Pin	4
22	PT-31	Fluid Tube, Galv.	1
23	PT-78-K10 or PT-78-K60	Tank Liner (Kit of 10 or 60)	1
24	PT-426	Lid, Zinc Plated	1
25	SSP-462-ZN	Hex Nipple 1/4" NPT(M)	1
26	SS-2707	Air Relief Valve	1
27	83-4233	D. M. Nipple (Universal Pipe Thread) (83C-210, 83C-211)	2
		(83C-220, 83C-221)	3
63	KK-5057	Clamp, Pin & Screw Kit (Includes 1 Ea. Ref. Nos. 18, 19, 20 & 21)	1
65	KK-5076	Safety Valve & Drain Valve Kit (Includes 1 Ea. Ref. Nos. 13 & 26)	1

* Purchase locally.
 Suffixes -K2, K5, K10 designate kits of multiple parts.

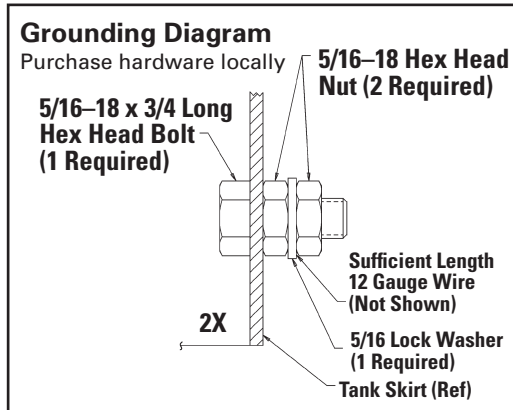

83C-210 PRESSURE TANK
 (Includes Ref. No. 1, 2 and 18 thru 23)

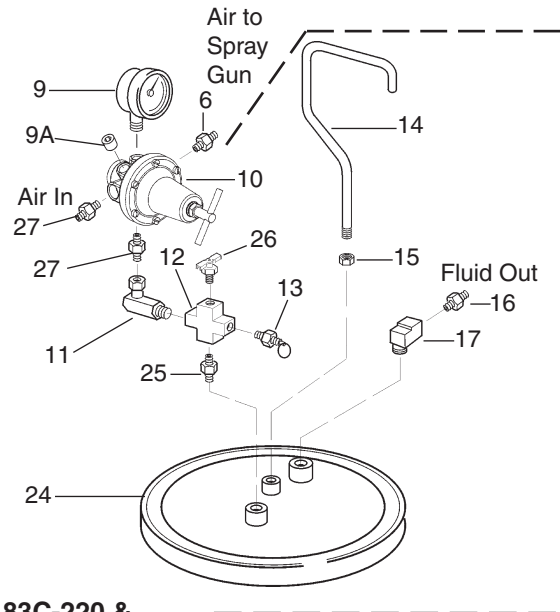

83C-220 & 83C-221 PRESSURE TANK (Dual Regulation included with these models)

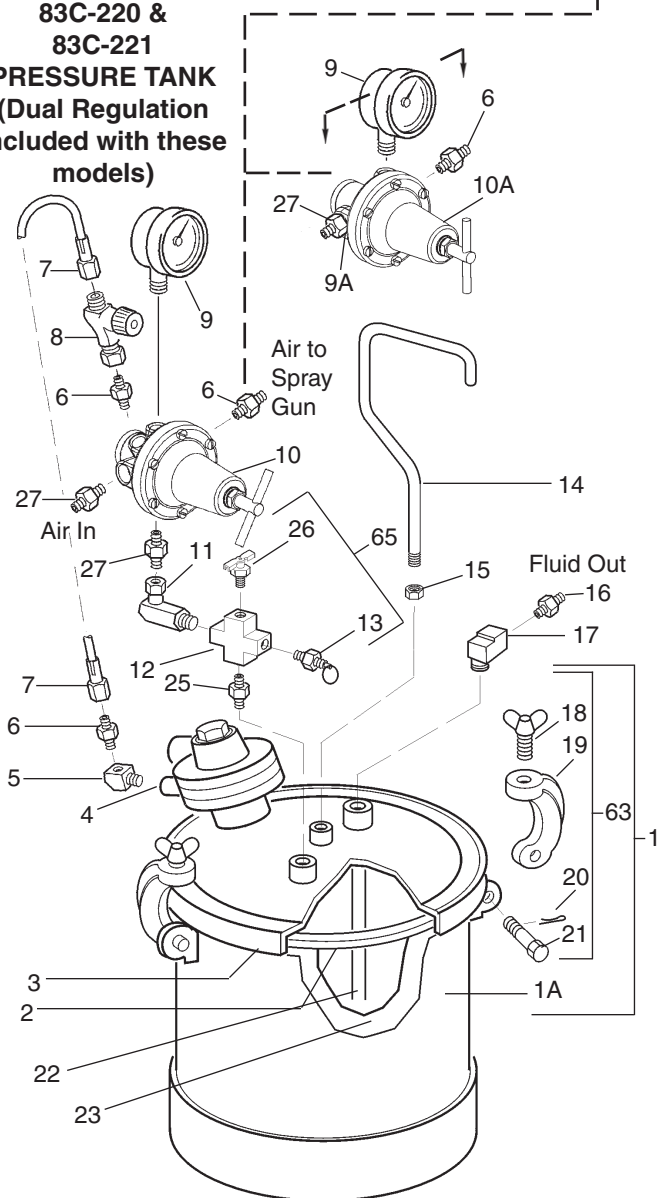

83C-211 PRESSURE TANK WITH AGITATOR

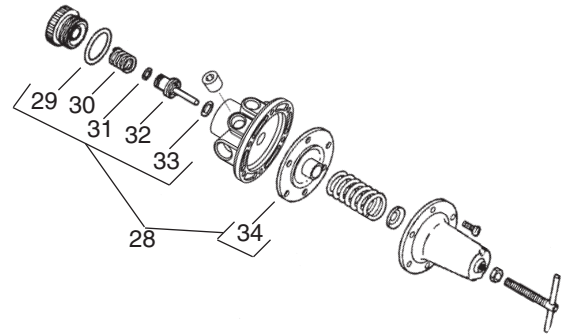
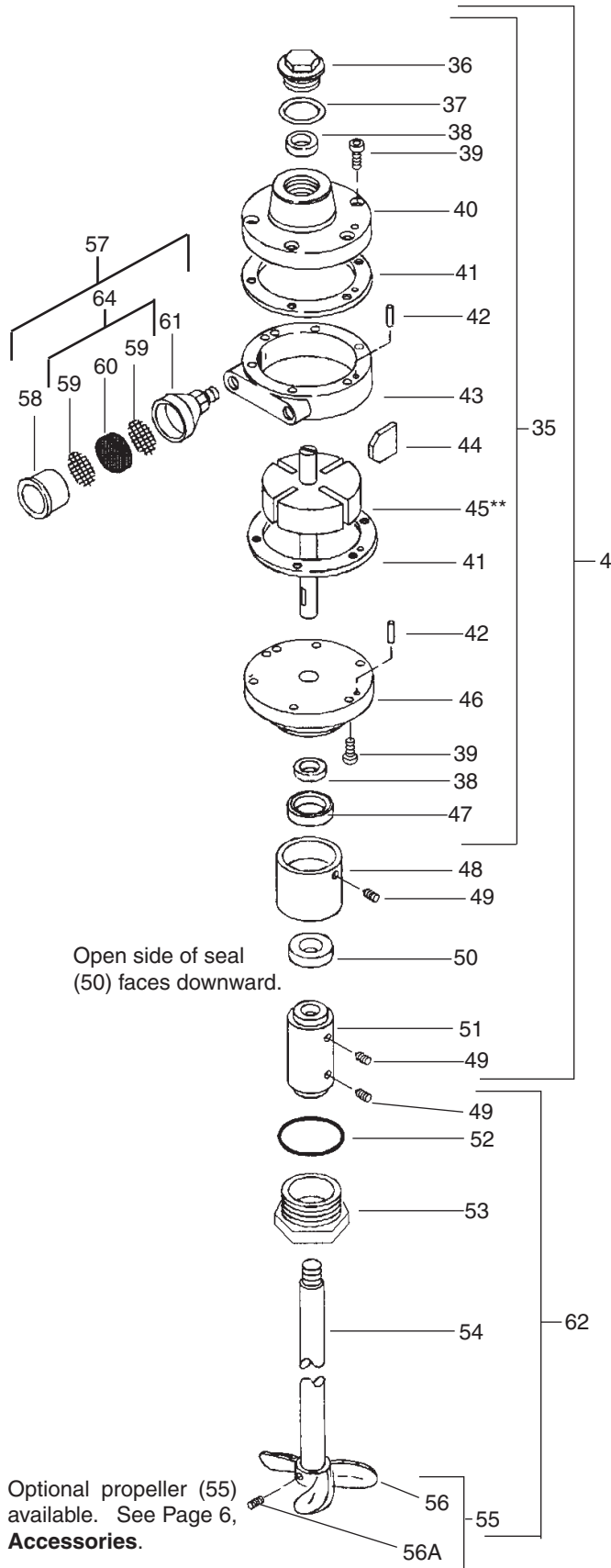

**HAR-507 (Ref. No. 10A) & HAR-511 (Ref. No. 10)
REGULATOR ASSEMBLIES (HAR-511 shown)**

Ref. No.	Replacement Part No.	Description	Individual Parts Req.
28	KK-4977	Repair Kit	1
29	---	"O" Ring	1
30	---	Spring	1
31	---	"O" Ring	1
32	---	Valve	1
33	---	"O" Ring	1
34	---	Diaphragm Assembly	1
35	PT-410	Air Motor Assembly	1
36	QS-190	End Cap	1
* 37	---	End Cap Gasket	1
38	PT-58	Bearing	2
39	Purchase locally	Screw (1/4"-28 x 1/2")	12
40	---	Front Plate	1
* 41	PT-59-1-K10	End Plate Spacer	2
42	QS-189-1-K10	Dowel Pin (Kit of 10)	4
43	---	Body	1
* 44	---	Vane	4
45	---	Rotor Assembly	1
46	---	End Plate	1
47	37-90	Shaft Seal	1
+ 48	PT-50	Air Motor Adapter	1
+ 49	Purchase locally	Set Screw (1/4"-20 x 1/4")	4
+ 50	KK-5041	Seal Assembly	1
• 51	QMG-441	Shaft Coupling Kit (Includes #49)	1
+ 52	SSG-8096-K5	"O" Ring (Kit of 5)	1
+ 53	PT-70	Adapter Nut	1
• 54	QMG-56	Shaft	1
• 55	QMS-448	Propeller Assy.	1
56	---	Propeller	1
56A	Purchase locally	Set Screw (1/4"-20 x 3/8" S.S.)	1
57	350-401	Muffler Assembly	1
58	---	Body	1
59	---	Screen	2
* 60	---	Felt	1
61	---	Cap	1
62	PT-428	Agitator Shaft Assembly (Includes 1 Ea. Ref. Nos. 49, 52, 53, 54 & 55)	1
64	KK-5006	Strainer Screen & Felt Kit (Includes 2 Ea. Ref. No. 59 & 4 Ea. Ref. No. 60)	1

PT-418 Air Motor/Adapter Ass'y (Ref. No. 4)
Includes Ref. Nos. 35, 48, 49, 50, & 51.

* Parts included in KK-5001-1 Air Motor Repair Kit.
+ Parts included in KK-5074 Air Motor Adapter Kit.
• Parts included in KK-5075 Agitator Shaft Assembly.
(KK-5074 & KK-5075 Sold by ITW Automotive Refinishing only.)

SERVICE CHECKS

Condition	Cause	Correction
Air escaping from port on regulator cap.	Broken or damaged diaphragm.	Replace diaphragm.
Pressure creepage registered on gauge.	Dirty or worn valve seat in regulator.	Clean or replace valve seat.
Material tends to settle out rapidly.	Not enough agitation of material.	Increase agitation.
Air bubbles form in material.	Material being over-agitated.	Slow down agitator speed. Optional QMS-79 propeller (see Accessories) can be used to reduce the amount of agitation.
Air leakage at agitator seal assembly.	Defective seal assembly (50).	Replace (50).
Paint getting into bearing assembly of agitator.	Paint level in tank too high. Paint being over-agitated. Defective seal assembly (50).	Fill tank 2-3" below rim. Slow down agitator speed. Replace (50).
Fluid or air leak at lid gasket.	Defective lid gasket Thumb screws not tight.	Replace. Tighten.
Air motor seized. A. If agitator shaft does not turn by hand. B. If agitator shaft turns freely, check air motor.	Damaged seal assembly (50). Vaness (44) blackened/chipped at outer edges due to lack of oil.	Replace (50). Replace with Repair Kit KK-5001-1 and refer to air motor agitator lubrication instructions.

Note: Occasionally check gauge (9). The needle should return to zero with no pressure on the gauge.

PREVENTIVE MAINTENANCE**To Clean Equipment:**

1. If tank is equipped with agitator, turn off air to agitator first. This will prevent the possibility of paint contamination of the agitator air motor.
2. Turn off the main air supply to the tank.
3. Turn T-handle adjusting screw on tank regulator counterclockwise until no spring tension is felt.
4. Turn thumbscrew on air relief valve. Wait until pressure bleeds down.
5. Loosen thumb screws, tip clamps back and tip tank lid to one side.
6. Loosen spray gun air cap retaining ring about three turns.
7. Turn on the air supply to spray gun.
8. Place cloth over air cap on the gun and pull trigger. This will force material back through the hose, into the tank. Binks Solvent Saver 83GZ-5200 can be used to clean hoses and gun fluid passage.
9. Empty and clean tank and parts which come in contact with material. Use a suitable cleaning material.
10. Pour cleaning material into the tank.
11. Replace lid and tighten thumb screws and clamps.
12. Spray until clean solution appears.
13. Repeat steps 5 through 8.

Keep the safety valve clean at all times.

Air Motor Assembly

CAUTION

Failure to properly lubricate the air motor will result in premature motor failure and will void warranty.

Lubricate air motor daily by adding 4 or 5 drops of SAE 10 weight oil into air inlet fitting.

Clean the agitator shaft (54, Pg. 5) and the propeller (56) at the end of each day. Occasionally remove and clean the muffler strainer felt (60) or replace, if necessary.

NOTES

ACCESSORIES

PROSPECTOR™ PRESSURE TANK STRAINERS FOR 2 GALLON TANKS

Prospector™ strainers are an economical way to remove foreign material from paint, stain, lacquer and coatings.



Inner Diameter 8.75" (222.25mm)
 Outer Diameter 10.625" (269.87mm)
 Height/Depth 2.625" (66.67mm)
 Case Qty 20

PTS-2Gal-K20-200 200 micron
 (approx. 65 wire mesh)

PTS-2Gal-K20-400 400 micron
 (approx. 37 wire mesh)

PTS-2Gal-K20-600 600 micron
 (approx. 28 wire mesh)

SCRUBS® HAND CLEANER TOWELS

Scrubs® are a pre-moistened hand cleaner towel for painters. No water is needed.

29-3100
 ITW Industrial Finishing
 192218
 ITW Automotive Refinishing



PT-78-K10 & PT-78-K60 LINER

A molded polyethylene tank liner to reduce tank clean up time. The liner is made of tough, durable, leakproof polyethylene and can be re-used. May be used with all materials that are compatible with polyethylene. (Available in packages of 10 and 80 only.)



QMS-79 OPTIONAL PROPELLER

Used with light viscosity or waterborne materials where over-agitation may be a problem.



PT-413 AIR REGULATOR KIT

Used to convert single regulated tanks (fluid only), to dual regulation (fluid and air). Used with portable air compressors or with air lines when no other means (air transformers or regulators) of air pressure regulation is available.

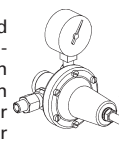

Ball Valves. VA-542 air inlet shut-off valve. To install, replace the 83-4233 D.M. nipple with a bushing – 3/8(m) x 1/4(f) – purchased locally. Attach ball valve.



VA-540 fluid outlet shut-off valve. To install, remove the AD-11 adapter. Using these valves will simplify attachment of air and fluid hoses.

WARRANTY

This product is covered by Binks' 1 Year Limited Warranty.

Binks Sales and Service: www.binks.com

Binks

Binks has authorized distributors throughout the world. For technical assistance or the distributor nearest you, see listing below.

U.S.A./Canada Customer Service Office:

195 Internationale Blvd., Glendale Heights, IL 60139
 Toll-Free Telephone: 1-800-992-4657 (U.S.A. and Canada only)
 Toll-Free Fax: 1-888-246-5732

DeVilbiss Automotive Refinishing

Binks has authorized distributors throughout the world. For equipment, parts and service, check the Yellow Pages under "Automotive Body Shop Equipment and Supplies." For technical assistance, see listing below.

U.S.A./Canada Customer Service Office:

11360 S. Airfield Road, Swanton, OH 43558
 Toll-Free Telephone: 1-800-445-3988 (U.S.A. and Canada only)
 Toll-Free Fax: 1-800-445-6643

