

Operating Instructions

The New Elcometer 456 Coating Thickness Gauge



The Elcometer 456 is available in 4 models. This User Guide is written for the Model T. Where applicable the Model E, Model B and Model S are referenced.



The Elcometer 456 Models S & T meet the Radio and Telecommunications Terminal Equipment Directive. The Models E & B meet the Electromagnetic Compatibility Directive. This product is Class B, Group 1 ISM equipment according to CISPR 11. Class B product: Suitable for use in domestic establishments and in establishments directly connected to a low voltage power supply network which supplies buildings used for domestic purposes. Group 1 ISM product: A product in which there is intentionally generated and/or used conductively coupled radio-frequency energy which is necessary for the internal functioning of the equipment itself.



This device complies with Part 15 of the FCC Rules. Operation is subject to the following two conditions: (1) this device may not cause harmful interference, and (2) this device must accept any interference received, including interference that may cause undesired operation.

Elcometer 456 Models S & T: The Giteki mark, its ordinance number and the FCC ID can be accessed via: Menu/About/Legal/Regulatory

NOTE: This equipment has been tested and found to comply with the limits for a Class B digital device, pursuant to Part 15 of the FCC Rules. These limits are designed to provide reasonable protection against harmful interference in a residential installation. This equipment generates, uses and can radiate radio frequency energy and, if not installed and used in accordance with the instructions, may cause harmful interference to radio communications. However, there is no guarantee that interference will not occur in a particular installation. If this equipment does cause harmful interference to radio or television reception, which can be determined by turning the equipment off and on, the user is encouraged to try to correct the interference by one or more of the following measures:

- Reorient or relocate the receiving antenna.
- Increase the separation between the equipment and receiver.
- Connect the equipment into an outlet on a circuit different from that to which the receiver is connected.
- Consult the dealer or an experienced radio/TV technician for help.

Modifications not expressly approved by Elcometer Limited could void the user's authority to operate the equipment under FCC rules.

This Class B digital apparatus complies with Canadian ICES-003

elcometer® is a registered trademark of Elcometer Limited, Edge Lane, Manchester, United Kingdom

 **Bluetooth®** are trademarks owned by Bluetooth SIG Inc and licensed to Elcometer Limited.
Bluetooth SIG QDID = B014393

All other trademarks acknowledged.

Gauge dimensions: 141 x 73 x 37mm (5.55 x 2.87 x 1.46").

Gauge Weight: Integral: 156g (5.5oz) including batteries; Separate: 161g (5.68oz) including batteries.

Applicable patents:

US6243661; US5886522; US6762603; US7606671; GB2306009; GB2367135; GB2342450; DE10131827

© Elcometer Limited 2011-12. All rights reserved. No part of this document may be reproduced, transmitted, transcribed, stored (in a retrieval system or otherwise) or translated into any language, in any form or by any means (electronic, mechanical, magnetic, optical, manual or otherwise) without the prior written permission of Elcometer Limited.

CONTENTS

Section	Page
1 GAUGE OVERVIEW AND BOX CONTENTS.....	4
2 GETTING STARTED.....	5
3 TAKING A READING.....	7
4 CALIBRATING THE GAUGE.....	8
5 THE DISPLAY.....	9
6 THE GAUGE FEATURES.....	12
7 MEASUREMENT MODES (ST).....	25
8 BATCHING (ST).....	26
9 DOWNLOADING DATA USING ELCOMASTER 2.0 (BST).....	35
10 ELCOMASTER FOR ANDROID (ST).....	55
11 CLOUD COMPUTING USING ELCOMASTER (ST).....	56
12 GETTING THE MOST OUT OF ELCOMASTER.....	58
13 CALIBRATING THE ELCOMETER 456 (EBST).....	60
14 CHANGING THE WELCOME SCREEN (BST).....	64
15 GAUGE FIRMWARE UPDATES (BST).....	65
16 GAUGE ICONS & ERROR CODES (EBST).....	66
17 GAUGE MENU STRUCTURES (EBST).....	70
18 ABOUT IMO PSPC (ST).....	74
19 GAUGE TECHNICAL SPECIFICATIONS (EBST).....	75
20 PROBE TECHNICAL SPECIFICATIONS (EBST).....	76
21 GAUGE & PROBE ACCESSORIES (EBST).....	80
22 ADDITIONAL REFERENCE INFORMATION.....	82
23 INDEX.....	82

Thank you for your purchase of this Elcometer 456 Coating Thickness Gauge. Welcome to Elcometer.

Elcometer are world leaders in the design, manufacture and supply of coatings inspection equipment. Our products cover all aspects of coating inspection, from development through application to post application inspection.

The Elcometer 456 Coating Thickness Gauge is a world beating product. With the purchase of this gauge you now have access to the worldwide service and support network of Elcometer.

For more information visit www.elcometer.com

ABOUT YOUR GAUGE

The Elcometer 456 Coating Thickness Gauge is a handheld gauge for fast and accurate measurement of the thickness of coatings on metal substrates.

The gauge is available in four models; Model E, B, S and T.

This manual describes the operation of all the Elcometer 456 models and indicates, where necessary, which specific model(s) the feature is available on in brackets after the feature.

All versions of the gauge feature an easy-to-use menu driven graphical interface which guides the user through tasks such as gauge configuration and calibration adjustment.

The gauge is available either with a built-in integral probe or as a separate probe version. A wide range of probes is available to suit requirements.

CONVENTIONS IN THESE INSTRUCTIONS

The Elcometer 456 is operated using a simple menu structure which helps you get the most from your gauge.

As an example, the Languages option is located within Setup which is under the Menu softkey and is shown in these instructions as:

Menu/Setup/Language

1 GAUGE OVERVIEW AND BOX CONTENTS



Gauge Overview

- 1 LED Indicators - Red (left), Green (right)
- 2 Colour Screen
- 3 Multifunction Softkeys
- 4 On/Off Key
- 5 Internal Probe / Separate Probe Connection
- 6 USB Data Output Socket (below cover)
- 7 Battery Compartment (¼ turn open/close)
- 8 Wrist Strap Connection

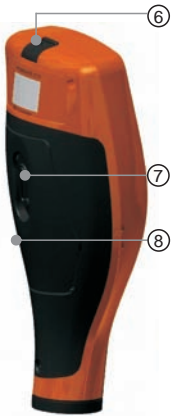

Box Contents

- Elcometer 456 Coating Thickness Gauge
- Calibration Foils (Integral gauges)
- Test Certificate
- Wrist Harness
- Protective Case (B, S & T models)
- Transit Case (T model)
- 1 x Screen Protector (S & T models)
- 2 x AA Batteries
- USB Cable & ElcoMaster™ 2.0 Software (S & T models)
- User Guide

Packaging

The gauge is packed in cardboard packaging. Please ensure that this packaging is disposed of in an environmentally sensitive manner. Please Consult your Local Environmental Authority for further guidance.

en 2 GETTING STARTED

Fitting the batteries

Your gauge is supplied with batteries ready to fit. To insert or replace the batteries:

1. Lift the latch at the back of the gauge and rotate anticlockwise.
2. Remove the battery compartment cover.
3. Insert 2 batteries (type LR6/AA) taking care to ensure correct battery polarity.
4. Replace battery compartment cover and rotate the latch clockwise to close.

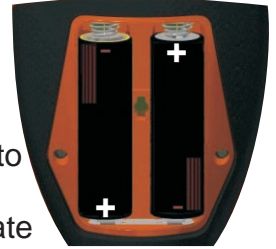

The battery condition is indicated by a symbol in the top right of the display:

- Full symbol (orange) = batteries at full capacity
- Empty symbol (red, flashing) = batteries at lowest sustainable level

To maximise battery life, ensure that Auto Screen Brightness is selected, or the screen brightness is low via **Menu/Setup/Screen Settings/Screen Brightness** and the Bluetooth is disabled (if you are not using it) via **Menu/Bluetooth** and uncheck the **Enable Bluetooth** radio button.

Connecting the probe (separate gauges only)

1. Rotate the probe plug to align the pins
2. Screw in the collar - clockwise



Fitting the wrist harness

A wrist harness is supplied with each gauge. This can be fitted into the right hand side of the gauge using the wrist strap connection. To fit the harness, pass the harness loop through the wrist strap connection, pass the main wrist harness through the loop and pull.

Switching the gauge on/off

- To switch on, press on/off key for more than 0.5 seconds.
- To switch off, press and hold on/off key until the screen blanks.

The gauge will switch off automatically after 5 minutes of inactivity. To switch off this feature, press **Menu/Setup** and uncheck the **Gauge Auto Off** radio button.

Selecting a language

When the gauge is switched on for the first time after dispatch from the Elcometer factory the display will show the language selection screen:

1. Select your language using the **↑↓** softkeys
2. Follow the on screen menus

To access the language menu when in a foreign language:

1. Switch the gauge OFF
2. Press and hold the left softkey and switch the gauge ON
3. Select your language using the **↑↓** softkeys

The language can also be changed via **Menu/Setup/Language**

Selecting units

The Elcometer 456 can display readings in both metric and imperial measurement units (microns, millimetres, mils or inches).

The appropriate measurement unit can be changed via **Menu/Setup/Units**

Adjusting the beep volume

Each time a measurement is taken, the gauge will beep. The beep volume can be adjusted and can even be switched off via **Menu/Setup/Beep Volume**

er 3 TAKING A READING

1. Hold the gauge (integral) or the probe by its sleeve (separate gauge)
2. To take a reading, bring the probe down onto the surface whilst holding it perpendicular
3. For subsequent readings, lift the probe off and then replace it onto the coated surface

✓ DO

- Hold the probe by the probe sleeve
- Gently place the probe onto the surface
- Allow the sleeve to make contact with the surface - to improve accuracy

× DO NOT

- Drag the probe over the coated surface
- Bang the probe down hard onto the surface
- Allow the probe to hover over the surface as this could result in a false reading

4 CALIBRATING THE GAUGE

Calibration adjustment is the process of setting the gauge to known values of thickness to ensure accuracy on different substrate types, shapes and surface finishes.

The calibration of the gauge can be adjusted using several different methods for use in accordance with National and International Standards and the calibration adjustment method chosen depends on the condition of the substrate to be measured.

1. Press the Cal softkey
2. For alternative calibration methods, select **Cal/Cal Method**
3. Select Calibrate and follow the on-screen instructions
4. When prompted place the probe on the centre of the foil(s) or on the uncoated metal substrate

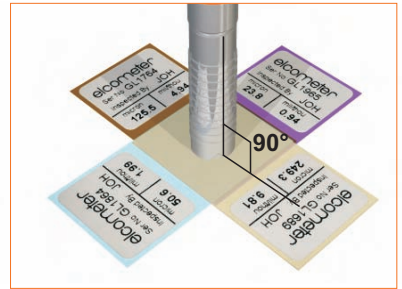

Foils can also be stacked to increase the thickness value.

The calibration method is indicated on the screen by a symbol - see Multiple Calibration Methods on page 18.

Not all calibration methods are available for all gauge types. For a comprehensive guide to each calibration method and the calibration adjustment process see Multiple Calibration Methods on page 18.

When using an FNF probe it must be calibrated in both the ferrous mode and in the non-ferrous mode to ensure accuracy of reading.

When using an Ultra/Scan probe in **Scan Mode** or **Auto Repeat Mode** (see Measurement Modes on page 25), it must be calibrated using either the **Smooth** or **Rough/2 Point** calibration method - see Multiple Calibration Methods on page 18.

For more information on calibrating the Elcometer 456, see page 60.

en 5 THE DISPLAY

The Elcometer 456 gauge has a colour display:

- White characters: All measurement and statistical values.
- Orange characters: All menu items, statistical parameters and symbols.
- Red: A measurement value which is outside set limits; a limit symbol when the limit value has been exceeded (Model S & T).
- - - - indicates reading outside range of probe.

If you see the **Cal** softkey flashing, the gauge should be calibrated.

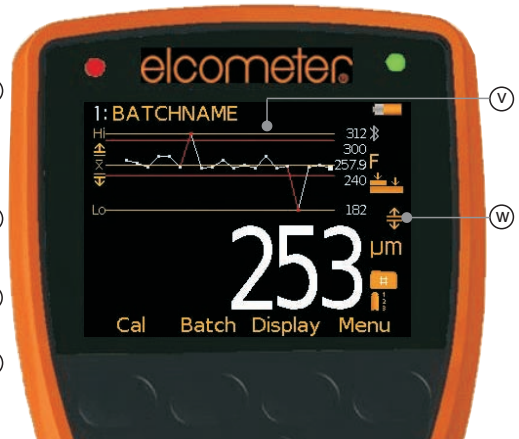
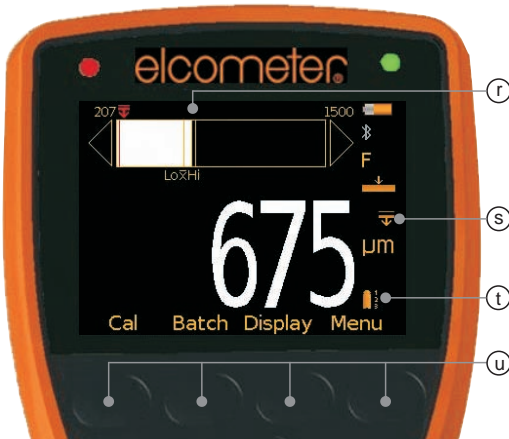

	<u>Model</u>
a Green LED	EBST
b Battery Life Indicator	EBST
c Bluetooth On	ST
d Substrate Type - F, N, FNF	EBST
e Calibration Method	BST
f Reading Outside Calibration Warning On	T
g Upper Limit On	ST
h Units of Measurement - µm, mils, mm, inch	EBST
i Batch Type - normal, counted average, IMO	ST
j Menu Softkey	EBST
k Display Softkey	BST
l Red LED - Reading outside limit/ IMO Fail	ST
m Batch Name (when in batching) Date & Time (when not in batching)	T ST
n User Selectable Statistics - 4 rows	BST
o Reading Value	EBST
p Calibration Softkey	EBST
q Batch / Data Softkey	BST
r Bar Graph - highest, lowest & average reading	BST
s Lower Limit On	ST
t Measurement Mode - Standard, Auto Repeat, Scan	T
u Softkeys	EBST
v Run Chart - last 20 readings	ST
w Upper & Lower Limits On	ST

For a complete list of icons, see “Gauge Icons” on page 66 - 68

en Reading display size (BST)

The character size of the measurement value on the display increases or decreases depending on the number of statistics that are displayed; or if a graph is displayed on the measurement screen . To maximise the reading size, either:

- reduce the number of statistical values that are displayed via **Display/Statistics/Select Statistics**, or
- display the reading only by checking the **Display/Readings Only** radio button.

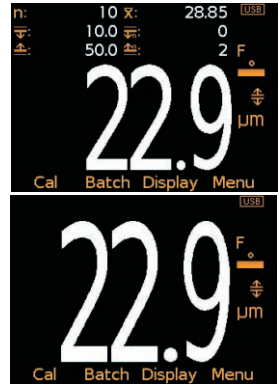

6 THE GAUGE FEATURES

The Elcometer 456 coating thickness gauge has a number of easy to use features and functions to help the user be more efficient. These include:

Fast reading rate (EBST)

The Elcometer 456 is capable of taking greater than 70 accurate, repeatable and reproducible measurements every minute.

Easy to use menu structure in more than 30 languages (EBST)

Designed to be intuitive, the Elcometer 456 menus and calibration instructions are available in multiple languages via **Menu/Setup/Language**.

Bright colour screen (EBST)

Each gauge is supplied with a scratch and solvent resistant 2.4" (60mm) TFT colour screen which clearly displays the reading. The screen brightness can be adjusted manually (EBST) - via **Menu/Setup/Screen Settings/Screen Brightness/Manual** or automatically (BST) using the gauge's ambient light sensor which can be switched on via **Menu/Setup/Screen Settings/Screen Brightness/Auto**.

Battery or USB Powered (EBST)

Each gauge can be powered either using 2 x AA lithium, alkaline or rechargeable batteries or by connecting the Elcometer 456 to your PC via a USB cable.

Two year gauge warranty (EBST)

The Elcometer 456 gauge is supplied with a 1 year warranty against manufacturing defects. To extend this warranty to 2 years, simply register your gauge via the elcometer.com website.

Emergency light mode (BST)

If all the lighting fails during an inspection in dark environments, the gauge is fitted with an emergency light feature - once selected (**Menu/Emergency Light**), the display turns bright white. To switch off this function either press and hold the **Esc** softkey or power off the gauge.

en Automatic rotating display (BST)

Using the internal accelerometer, the gauge will automatically rotate the display to allow you to easily read the thickness value in any orientation - 0°, 90°, 180° & 270°.

This function can be switched off by un-checking **Menu/Setup/Screen Settings/Auto Display Rotation**



Gauge firmware updates (BST)

Using Elcometer's free data management software, ElcoMaster 2.0, users can receive prompts when there is a gauge firmware update available for their model version.

When the Elcometer 456 is connected (via USB), to any computer with an internet connection and with ElcoMaster 2.0 installed, ElcoMaster 2.0 highlights the availability of a firmware update, identifies to the user the new features and guides the user through the gauge firmware update process.

Caution, before upgrading your gauge firmware, ensure that you have downloaded all inspection readings from the gauge. For more information regarding ElcoMaster 2.0 see page 35 Downloading Data.

Bluetooth™ (ST) and USB Data output (BST)

Elcometer 456 gauges have the ability to transfer data via USB (BST) to a computer or wirelessly via Bluetooth™ (ST) technology to PC's, PDA's or mobile phones which are Bluetooth™ enabled using ElcoMaster 2.0 or ElcoMaster™ for Android™ respectively.

Bluetooth™ data output can be switched on via **Menu/Bluetooth/Enable Bluetooth**. For more information regarding ElcoMaster 2.0 see page 35 Downloading Data.

ElcoMaster 2.0 Data output (BST)

Users can download data from any Elcometer gauge directly into ElcoMaster 2.0 by connecting the gauge to the PC and following the on screen prompts.

Once the data has been transferred to the computer, the user can produce professional reports in seconds. Data can also be transferred into programs, such as Excel®, in a similar manner.

For more information regarding ElcoMaster 2.0 see page 35 Downloading Data.

Counted Average (BST)

Users can define the number of individual gauge readings to be taken within a spot or measurement area using the Counted Average function. The gauge stores the average of the individual readings into memory. The individual readings within the counted average are not saved. Select **Display/Statistics/Counted Average**.

Counted Average is also available when in Batching (ST) - see BatchTypes on page 32.





On Screen Statistics (BST)

User selectable statistical and general measurement information can be displayed on the gauge. The information to be displayed can be selected and managed by selecting the **Display** softkey.

- Up to 8 statistics can be selected to be displayed on the reading screen via **Display/Statistics/Select Statistics**
- Ensure that **Display/Readings & Selected Stats** is also checked.
- To view all statistics select **Display/Statistics/View All**

The following statistical and general information can be displayed on your gauge:

Symbol / icon	Model	Description
ç	BST	The number of readings taken
\bar{x}	BST	Mean (average)
ó	BST	Standard deviation
Hi	BST	Highest reading taken
Lo	BST	Lowest reading taken
cv%	BST	Coefficient of variation; The COV is defined as the ratio of the standard deviation to the mean and is a normalised measure of dispersion - when comparing batches with widely different means, one should use the coefficient of variation for comparison instead of standard deviation (ó).

Symbol / icon	Model	Description
EIV	BST	Elcometer index value; Used to assess a coating's overall quality. Ideal for use in the automotive refinishing industry. USA patent number US7606671.
NDFT	ST	Nominal dry film thickness; The target or specified dry film coating thickness value.
IMO PSPC	ST	International Maritime Organisation's Performance Standard for Protective Coatings clearly defines the acceptance criteria for a coating. The Elcometer 456 can be quickly set up to display these parameters:
$\% \geq N$	ST	The percentage of readings greater than or equal to the Nominal Dry Film Thickness Value.
$\% \frac{90}{100}$	ST	The percentage of readings between $0.9 \times \text{NDFT}$ and the NDFT.
90:10	ST	Displays either pass (✓) or fail (X) To pass the IMO PSPC 90/10 rule: <ul style="list-style-type: none"> • At least 90% of all dry film thickness readings shall be greater than or equal to the NDFT value, and • none of the remaining measurements shall be below $0.9 \times \text{NDFT}$
X!	ST	If all the measurements taken at any point are greater than $0.9 \times \text{NDFT}$, but less than 90% of the readings are greater than or equal to the NDFT, were the inspection to stop, then the IMO PSPC condition would be a fail. Statistically, however, were more measurements to be taken which were all greater than or equal to the NDFT, then there would come a time when the IMO PSPC condition returns to a pass. This is depicted by the "failing" icon - X!. For more information on the IMO PSPC see About IMO PSPC on page 74.
	ST	Low Limit
	ST	High Limit
	ST	Number of readings below the low limit
	ST	Number of readings above the high limit
		User definable warning limits can be set. Once the reading exceeds the limit the gauge notifies the user by turning the reading and relevant limit icon red, flashing the red LED, and sounding the alarm beep. For more information see Limits on page 23.

Analogue Bar Graph (BST)

By selecting **Display/Readings & Bar Graph** the user can view an analogue representation of the current thickness value together with the highest (Hi), lowest (Lo) and average (\bar{x}) reading. The graph is updated automatically when each reading is taken.

The values on the top left and right of the bar signify the measurement range using the thin calibration foil value less 10% and the thick calibration foil value plus 10%. If calibrated using the factory calibration, the probe scale range $\pm 10\%$ is used. If limits are set, the limit values $\pm 10\%$ are used and the relevant limit icon is displayed above the bar in the appropriate position.

With Limits: The current measurement is displayed as a white or red bar; white if within set limits, and red if outside set limits.

If below the lower limit, the left arrow head is also filled red and if above the upper limit, the right arrow head is filled red.

If the next measurement taken is within set limits, the left or right arrow outline will remain red to signify that the previous reading was outside set limits.

Without Limits: The current measurement is displayed as a white bar.

If outside the measurement range, the left or white arrow head is also filled white.

If the next measurement taken is within range, the left or right arrow outline will remain white to signify that the previous reading was outside range.

- ▶ Users can choose to show **Readings & Selected Stats (ST)** - see On Screen Statistics on page 14, **Readings & Run Chart (ST)** - see Run Chart on page 17, **Readings & Bar Graph (BST)** or **Readings Only (BST)**. **Readings & Run Chart** is only available when in Batching, it is not available in Standard (Immediate) Mode.

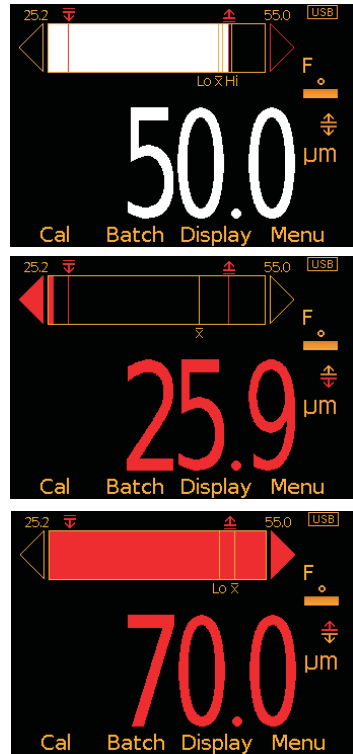

en Run Chart (ST)

By selecting **Display/Readings & Run Chart** the user can view a line trend graph of the last 20 measurements. The graph is updated automatically when each reading is taken.

Up to five horizontal axes are displayed representing different values / statistics as follows:

- Highest reading in the batch “Hi”
- Lowest reading in the batch “Lo”
(for batches of more than one reading)
- Mean of readings in the batch “ \bar{x} ”
(for batches of more than one reading)
- High limit for the batch “ \pm ” (when enabled)
- Low limit for the batch “ \mp ” (when enabled)

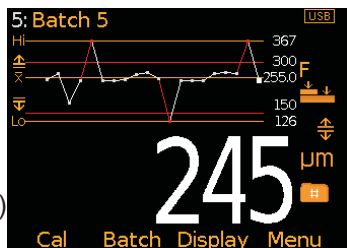

The readings are displayed as white or red points; white if a reading is within limits (or no limits have been set), and red if outside set limits.

When in **Scan Mode** (T) - see Measurement Modes on page 25, the Analogue Bar Graph is displayed on screen whilst scanning. This is replaced by the Run Chart when the scan is completed.

The highest and lowest reading for each scan is displayed on the run chart above and below the average value together with either a white or red vertical line; white if within set limits, and red if outside set limits.

The highest, average and lowest reading values for the last scan are also displayed under the run chart.

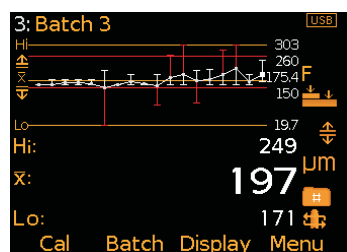

- ▶ Users can choose to show **Readings & Selected Stats** (ST) - see On Screen Statistics on page 14, **Readings & Run Chart** (ST), **Readings & Bar Graph** (BST) - see Analogue Bar Graph on page 16 or **Readings Only** (BST). **Readings & Run Chart** is only available when in Batching, it is not available in Standard (Immediate) Mode.

Time and date (ST)

Once the appropriate time and date has been set (**Menu/Setup/Time and Date**), the user can display the time and date at the top of the Elcometer 456 display via **Menu/Setup/Time and Date/Display Time and Date**.

- The time format can be set to either the 12 hour or 24 hour clock via **Menu/Setup/Time and Date/Set Format/Set Time Format**
- The date format can be set to either dd/mm/yyyy, mm/dd/yyyy or yyyy/mm/dd via **Menu/Setup/Time and Date/Set Format/Set Date Format**

Please note that the time and date is replaced by the batch name when the gauge is in Batch mode.

When a batch is created, re-opened (or when the gauge is switched on whilst in batch mode) and when each reading is taken, the time and date details are stored within the batch - allowing the user to have an accurate record of when the measurements were taken. The time and date stamp for each reading is displayed on ElcoMaster 2.0.

Multiple calibration methods (EBST)

Calibration adjustment is the process of setting the gauge to known values of thickness to ensure accuracy on different substrate types, shapes and surface finishes and is often referred to as simply the “calibration”.





The calibration of the gauge can be adjusted using several different methods for use in accordance with National and International Standards and the calibration adjustment method chosen depends on the condition of the substrate to be measured.

The calibration method is indicated on the screen by a symbol.

When using an FNF probe it must be calibrated in both the ferrous mode and in the non-ferrous mode to ensure accuracy of reading.

When using an Ultra/Scan probe in **Scan Mode** or **Auto Repeat Mode** (see Measurement Modes on page 25), it must be calibrated using either the **Smooth** or **Rough/2 Point** calibration method.

When switching between the Scale 1 and Scale 2 functions of the scale 2 probes (**Menu/Setup/Probe**) the Elcometer 456 should be re-calibrated to ensure accuracy across the appropriate measurement range.

Method	Description	Icon	Model								
Zero	A simple method for calibrating on smooth substrates. Simply place the probe on the uncoated metal and the gauge will adjust the calibration accordingly. Also known as the single point calibration method.		BST								
Smooth	This is a more accurate method of calibrating the gauge than the Zero method as it requires the user to calibrate the gauge using a foil and the un-coated substrate. The gauge's on-screen calibration instructions will guide the user through the calibration routine. When selecting the foil value, the user should choose a thickness that is close to but greater than the expected dry film thickness value.		BST								
Rough / 2 Point	Ideal for calibrating the gauge on both profiled metal substrates (when the uncoated surface is accessible) and substrates where there are significant differences in the magnetic (F) or electrical (N) properties of the substrate. For example cast iron, high carbon steel or some non-magnetic stainless steel alloys. The calibration requires 2 foil values - one above the expected dry film thickness, and one below. The gauge will guide the user through the process with on screen instructions.		EBST								
Zero Offset	This is the ISO 19840 method for coatings on steel surfaces roughened by blast cleaning or when the substrate profile is unknown, or not accessible. The calibration uses the smooth surface technique, and a correction value (zero offset) is applied to each reading to account for the effect of the roughened surface; the value of the offset depends on the initial surface profile and is described in ISO 19840 as follows: <table border="1" data-bbox="311 1264 845 1428"> <thead> <tr> <th>Profile according to ISO 8503-1</th> <th>Correction Offset Value μm (mils*)</th> </tr> </thead> <tbody> <tr> <td>Fine</td> <td>10 (0.4)</td> </tr> <tr> <td>Medium</td> <td>25 (1.0)</td> </tr> <tr> <td>Coarse</td> <td>40 (1.6)</td> </tr> </tbody> </table>	Profile according to ISO 8503-1	Correction Offset Value μm (mils*)	Fine	10 (0.4)	Medium	25 (1.0)	Coarse	40 (1.6)		ST
Profile according to ISO 8503-1	Correction Offset Value μm (mils*)										
Fine	10 (0.4)										
Medium	25 (1.0)										
Coarse	40 (1.6)										

* mils values are calculated and for reference as ISO 19840 indicates metric units only

Method	Description	Icon Model
Auto	<p>This is a calibration method unique to the Elcometer 456 and has been designed to simplify and speed up the calibration process for those users who are calibrating their gauge using the same foil values each time.</p> <p>When the Auto calibration method is selected, the user is asked to pre-program the high and low foil values. The low foil value can be set to 0.0µm (0.0mils) for un-coated substrates.</p> <p>Once these foil values have been set up, selecting the calibrate routine allows the user to simply place the probe on the high foil three times, followed by the low foil three times and the gauge is automatically calibrated - returning the user to the main reading screen - automatically.</p>	ST
Factory	<p>By selecting this calibration method the Elcometer 456 returns the calibration to the gauge's factory calibration settings.</p> <p>The factory calibration method should only be used if there is no other means of calibration (e.g. lost foils, lack of access to substrate, etc.).</p>	 EBST

Pre-defined Calibration Methods (ST)

In addition to the standard calibration methods described on pages 16 - 18, the Elcometer 456 has a four pre-defined calibration methods which follow relevant standards.

These pre-defined calibration methods not only define the calibration routine to be used, but also set up the data collection method, as defined by the appropriate standard.

For this reason, pre-defined calibration methods can only be selected whilst the gauge is in batching mode. For more information on batching or data collection methods, see Batching on page 26.

Method	Description	Icon	Model
ISO	Sets the calibration method to Zero Offset and sets the Counted Average to 5 - in accordance with ISO19840.	ISO	ST
SSPC PA2	Sets the calibration method to Rough/2 Point and sets the Counted Average to 3 - in accordance with SSPC PA2.	SSPC	ST
Swedish	Sets the calibration method to Rough/2 Point and sets the Counted Average to 5 - in accordance with Swedish standards.	SWE	ST
Australian	Sets the calibration method to Zero Offset, and sets the Counted Average to 5 - in accordance with AS standards.	AS	ST

For more information on how to calibrate the gauge, see *Calibrating the Elcometer 456* on page 60.

User-programmable calibration memories (T)

The Elcometer 456 Model T allows users to store into memory up to three calibrations. Once a calibration memory has been saved, the user can select the calibration memory - without the need to re-calibrate the gauge.

Calibration memories are ideal for users who are inspecting coatings on various curvatures, blast profiles or coating thicknesses.

Using the gauge’s alpha-numeric function, users can re-name the calibration memory to suit the calibration setting.

For example:

- A user who is inspecting coatings on two blast profiles - shot and grit could store calibrations into Cal Memory 1 and Cal Memory 2 and re-name them ‘Shot’ and ‘Grit’ respectively
- A user measuring on flat and curved surfaces could store the calibrations into ‘Flat cal’ and ‘Curved cal’.
- Thick and thin coating thickness calibrations can also be saved and renamed ‘320µm’ and ‘120µm’

For more information on re-naming calibration memories, see *Alpha-numeric naming of batches and cal memories* on page 27.

Outside calibration warning (T)

In order to achieve the most accurate reading the gauge should be calibrated to the substrate type, shape and profile using the appropriate calibration method together with foil values that are slightly above the target dry film thickness.

When using the gauge's calibration memories, or batching (see Batching on page 26) different calibration foil values may be used in each calibration.

Once the Outside calibration warning function **Cal/Calibration Check** has been switched on, if a coating thickness reading is taken which is more than 10% above the foil value (and 10% below the lower foil

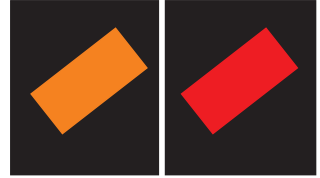

value if using Rough/ 2 point) the gauge reading alarm sounds a triple beep and the Calibration Check icon (located above the units symbol) turns red. This feature does not amend or tag any reading, it is a real time warning feature only.

Calibration lock (BST)

To avoid accidental amendments to the calibration settings switching on the **Cal/Calibration Lock** feature 'locks' the user from undertaking any changes to the calibration without first un-checking the **Cal/Calibration Lock** feature.

When the Calibration Lock is enabled, users can still test the calibration via **Cal/Test Calibration** but will be unable to validate or re-calibrate the gauge.

The calibration can also be locked using a PIN Code, see page 63 for more information.

en Gauge Memory (BST)

The Elcometer 456 versions are supplied with a varying level of memory:

Model E: No memory

Model B: The Model B gauge's 'rolling statistics' provides accurate statistical values for all measurements taken since the statistics were last cleared (**Display/Clear Statistics**). The last 5 readings, however, can be displayed by pressing the **Data** softkey.

Model S: 1,500 readings can be stored into the gauge's memory

Model T: A total of 150,000 readings can be stored into the gauge's memory either in a single batch or in up to 2,500 batches (see **Batching** on page 26). Each batch can be individually named and can have its own unique calibration.



Limits (ST)

During the inspection process coatings can often have specified minimum and/or maximum thickness values.

For example, coatings that have been applied too thinly over a surface profile can lead to rust spots appearing on the peaks of the profile. Similarly too thick a coating can also lead to premature coating failures.

Users can program upper and/or lower warning limits into the Elcometer 456 gauge by selecting **Menu/Set Limits/Set Upper** or **Menu/Set Limits/Set Lower**.

To switch the limits on, the user should ensure that the **Enable Limits** radio button is checked.

- When an Upper Limit has been set up and enabled the “” icon is displayed.
- When a Lower Limit has been set up and enabled the “” icon is displayed.
- If both Upper and Lower limits have been set up and enabled then the two icons are displayed together as “”.

When the Elcometer 456 gauge takes a reading which is outside the set limits the following occurs:

- The Red LED flashes
- The reading is displayed in red
- The alarm beeps 3 times
- The associated limit icon turns red



In addition, the number of readings above limit (or below limit as applicable) statistic is incremented. In Batching, the reading is tagged with either the high or low icon as appropriate. For more information see Batching on page 26.

To switch off a particular limit go to **Menu/Set Limits/Set Upper** or **Menu/Set Limits/Set Lower** and set the limit value to Off using the up and down soft keys.

The programmed limit values can be displayed on the reading screen via **Display/Statistics/Select Statistics** and checking the appropriate radio button. The maximum number of statistics that can be displayed on the reading screen at the same time is 8.

If a low limit has been set up, the upper limit value cannot be lower than the pre-set lower limit.

Individual limits can also be set up for each batch on Model T gauges. For more information see Batching on page 26.

Gauge Welcome Screen (BST)

Users can adjust the start up screen on their Elcometer 456 gauges via the ElcoMaster 2.0 software - see page 64 for more information.

7 MEASUREMENT MODES (ST)

The Elcometer 456 gauges have four measurement modes:

Standard (Immediate) Mode (ST): Where readings are taken, rolling statistics calculated (and displayed), but individual values are not stored in the memory.

Scan Mode (T): Specifically designed for use with Elcometer 456 Ultra/Scan Probes - see page 79, when Scan Mode is selected, the user can slide the Ultra/Scan Probe over the entire surface area. As the probe is lifted off the surface the average (\bar{x}), lowest (Lo) and highest (Hi) coating thickness values are displayed. When Batching, each set of three readings can be shown on a Run Chart - see page 17 and stored into memory.

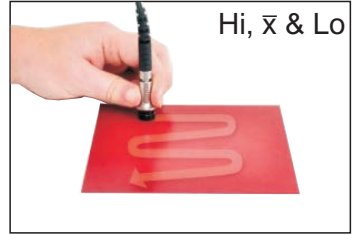

Scan Mode with Hold (T): As above but allows the probe to be lifted off the surface for a maximum of 1.5 seconds and replaced without starting a new set of readings - allowing the user to avoid holes, weld seams, etc. in the substrate without affecting the measurement results.

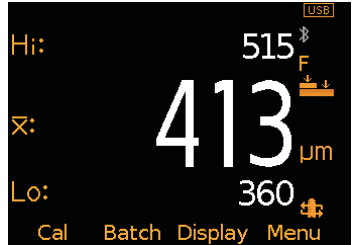

Auto Repeat Mode (T): When the probe is placed onto the coated substrate in Auto Repeat Mode, the gauge automatically takes readings at a rate of 140 per minute until the probe is removed from the substrate. When Batching, each individual reading is stored into the memory.

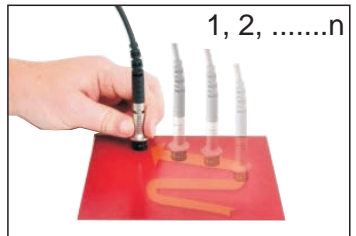

- ▶ Scan and Auto Repeat Modes are only available on Elcometer 456 Model T separate gauges. The probe end cap **must be** fitted to the Ultra/Scan Probe when used in these modes to avoid damage to the probe tip. Use in these modes without the cap will invalidate the probe warranty.

8 BATCHING (ST)

Readings can be stored into memory in batches. Batches allow the user to collate readings for easier analysis of large structures or complex assemblies. Elcometer 456 Model T gauges can store a total of 150,000 readings in up to 2,500 batches, the Model S has one batch of up to 1,500 readings.

The Elcometer 456 has the following batching functions:

- Create a new batch (ST); **Batch/New Batch**
- Open an existing batch (ST); **Batch/Open Existing Batch**
- Rename an existing batch (T); **Batch/Edit Batch/Rename Batch**
- Copy a batch - including all calibration and limit setups (T); **Batch/Copy Batch**
- Clear all the readings within the batch - but leaving all calibration and limit setups (ST); **Batch/Edit Batch/Clear Batch**
- Review the readings, statistics, calibration, batch information (ST) and a graph of the readings (T); **Batch/Review Batch**
- Delete a Batch (ST), or all batches (T), entirely from the gauge; **Batch/Edit Batch/Delete Batch**
- Delete the last reading entirely or delete the reading, but mark the reading as deleted in the batch memory (ST) - **Batch/Deleted Reading/Delete With Tag** and **Batch/Deleted Reading/Delete Without Tag** respectively.

Creating a new batch (T)

When using batching for the first time, or when you wish to open a new batch, press **Batch/New Batch**. The user can now:

- Open the batch and take readings; **Batch/New Batch/Open Batch 1**
- Rename the batch - before opening it via **Batch/New Batch/Rename Batch 1**. (See Alpha numeric naming Batches & Cal Memories on page 27)

- Select the appropriate calibration method - **Batch/New Batch/ Batch Calibration** (see Multiple calibration methods on page 18)
- Choose the type of batch (normal, counted average or IMO PSPC) before opening it via **Batch/New Batch/Batch Type** (see Batch Types on page 32)
- Set up specific batch limits via **Batch/New Batch/Batch Limits** (see Limits on page 23)
- Set up a fixed batch size via **Batch/New Batch/Fixed Batch Size** (see Fixed Batch Size on page 33)

Once all the batch settings have been created, press **Batch/New Batch/Open Batch 1** - where 'Batch 1' may now be a re-named as required.

Alpha numeric naming batches & cal memories (T)

When in batching - or setting up a calibration memory (see Calibration Memories on page 21) - the user can rename the batch or cal memory to a more appropriate name.

When a new batch is created, the gauge automatically names it 'Batch n' - where 'n' is the next unused batch number; e.g. Batch 1, Batch 2, Batch 3, etc.

To rename a batch either:

- when creating a new batch press **Batch/New Batch/Rename Batch 1**; or
- press **Batch/Edit Batch/Rename Batch** and select the Batch to be renamed from the list of existing batches

To rename a calibration memory:

- press **Cal/Cal Memory 1**; **Cal/Cal Memory 2** or **Cal/Cal Memory 3**
- then select **Rename Cal Memory n** (where n=1, 2 or 3)

This then opens up the renaming procedure to enable the user to rename the batch or cal memory.

The current name of the batch (or cal memory) is in white in the middle of the display with a yellow ‘cursor’ icon to the right of the name.

Using the left arrow, right arrow and Select softkeys, the user can rename the batch or cal memory as required.

The yellow, raised character or function is the item that will be ‘chosen’ by pressing the Select soft key.



Character	Action
OK	Stores the name and returns the user to the previous screen
⏪ X	Deletes the last character of the name
A, B, C...	Selects the character A, B or C, etc.
␣	Inserts a space
123	Changes the selection characters to: 1 2 3 4 5 6 7 8 9 0
ABC	Changes the selection characters to: A B C D E F G H J K L M N O P Q R S T U V W X Y Z
À Ç ü	Changes the selection characters to: À Á Â Ã Ä Å Æ Ç È É Ê Ë Ì Í Î Ï Ð Ñ Ò Ó Ô Õ Ö Ù Ú Û Ü Ý Þ ß µ m
\$ % &	Changes the selection characters to: ! # ' £ \$ € % & * [] _ - + / \ < > : @ ; ”

Pressing the **Esc** softkey at any time cancels the whole operation without making any changes to the original name.

To store the re-named ‘name’ highlight OK and press the Select softkey.

en Opening an existing batch (ST)

By selecting **Batch/Open Existing Batch** on the Model T, the user will find a list of all the batches that have already been created, together with the number of readings stored in each batch.

To open a particular batch use the up and down arrow soft keys and select the appropriate batch.

The Elcometer 456 will return the gauge to the main reading screen and the selected batch name will be shown at the top of the display (together with a unique gauge batch id number - allowing no two batches to have exactly the same name).

As the Model S only has one batch, the batch will open automatically.

Copying an existing batch (T)

By selecting **Batch/Copy Batch** the user will find a list of all the batches that have already been created, together with the number of readings stored in each batch.

To copy a particular batch use the up and down arrow soft keys and select the appropriate batch.

The Elcometer 456 will then copy all the batch settings - calibration and foil values, batch type, cal method, warning limits, and the batch name - and then ask the user whether they wish to rename the batch.

Pressing the **Yes** softkey the user will then be asked to rename the batch using the renaming procedure described on page 27.

Pressing the **No** softkey (or pressing the **Esc** softkey whilst in the renaming procedure) will make the Elcometer 456 copy the existing batch name to the new batch - thereby two batches will have the same batch name.

Copying a batch does not copy the individual readings within that batch.

Clearing an existing batch (ST)

By Selecting **Batch/Edit Batch/Clear Batch** on the Model T, the user will find a list of all the batches that have already been created, together with the number of readings stored in each batch.

To clear a particular batch's individual readings only, use the up and down arrow soft keys and select the appropriate batch.

As the Model S only has one batch, it is selected automatically.

After a request for confirmation, the gauge will clear the readings from the selected batch and return the gauge to the list of batches (T) or the Batch Menu (S).

To clear another batch (T), repeat the procedure. To return the gauge back to the previous menu, press the Back softkey.

The user can clear all batches via **Batch/Edit Batch/Clear Batch/All Batches** (T).

Reviewing an existing batch (ST)

By selecting **Batch/Review Batch** the user will find a list of all the batches that have already been created, together with the number of readings stored in each batch.

To review a particular batch use the up and down arrow soft keys and select the appropriate batch. As the Model S only has one batch, it is selected automatically.

The Elcometer 456 will then open up the Review Batch menu, allowing the user to:

- Review the statistics of the batch
- Review the batch information, including:
 - the date and time the batch was created
 - the batch type - normal, counted average or IMO PSPC
 - the probe type and serial number used to take the readings
 - the calibration method - smooth, rough/2 point, etc.
 - the batch limits (if set)
- Review the batch's calibration information, including:
 - the date and time the batch was last calibrated or verified
 - the substrate type (or types if using an FNF probe)
 - the probe type and serial number
 - the calibration method - smooth, rough/2 point etc.
 - the foil values used in the calibration
- Review the individual readings. The Elcometer 456 displays:
 - the readings in numerical order, the first reading is at the top
 - the substrate, time and date of measurement
 - icons indicating a reading above “ $\underline{\text{A}}$ ” or below “ $\overline{\text{B}}$ ” the limit
 - deleted readings icon “ O ” is displayed if “Delete With Tag” selected, (see page 26 for more information).
- Review a graph of the individual readings (T), see page 31.

en Batch Readings Graph (T)

By selecting **Batch/Review Batch/Batch Graph** the user can review all readings in the selected batch as a graph.

Up to five horizontal axes can be displayed representing different values / statistics as follows:

- Highest reading in the batch “Hi”
- Lowest reading in the batch “Lo”
- Mean of readings in the batch “ \bar{x} ”
- High limit for the batch “ \pm ”(when enabled)
- Low limit for the batch “ \mp ”(when enabled)

The readings are displayed as white or red vertical bars; white if a reading is within limits (or no limits have been set), and red if outside set limits.

If there are more readings in the batch than can be displayed on a single screen, multiple readings will be combined into one bar. Should a single reading within the ‘combined bar’ be outside the enabled limits, the whole bar will be red.

Pressing the **Zoom+** softkey, allows each individual reading to be displayed, thereby showing the individual readings outside the limits.

When zoomed in, the graph will always display the first 25 readings. Pressing the **←** softkey will display the last 25 readings taken. Subsequent presses of the **←** softkey will scroll backwards, pressing the **→** softkey will scroll forwards through the readings, 25 readings at a time.

Pressing the **Zoom-** softkey returns to the original overview graph of all readings in the batch.

To return the gauge to the Batch Review menu, press the **Back** softkey.

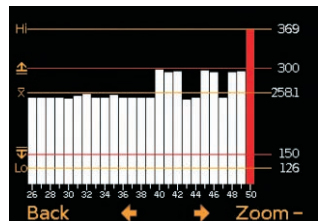
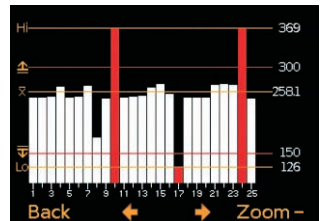
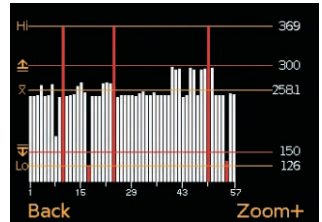
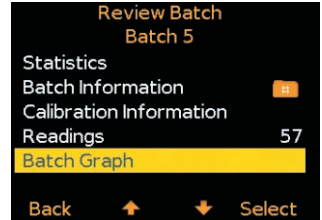

Delete an existing batch (ST)

By Selecting **Batch/Edit Batch/Delete Batch** the user will find a list of all the batches that have already been created (T) or a single batch (S), together with the number of readings stored in each batch.

To delete a particular batch's individual readings only use the up and down arrow soft keys and select the appropriate batch.

After a request for confirmation, the gauge will delete the selected batch and return the gauge to the list of batches.

To delete another batch, repeat the procedure, to return the gauge back to the previous menu, press the **Back** softkey.

The user can delete all batches from the gauge by selecting **Batch/Edit Batch/Delete Batch/All Batches (T)**.

Exit Batching (ST)

To stop using the Batching Mode and return to the Immediate mode select **Batch/Exit Batching**.

Batch Types (ST)

When saving readings into a batch you have a choice of how the readings are managed within the gauge:

Normal: Each reading is saved into memory.
Press **Batch/New Batch/Batch Type** and then select **Normal**.

The batch type can only be changed when creating a new batch.

n \bar{x} Counted Average: The average of a predefined number of readings is saved into memory. For example a counted average of 3 means:

The average of [Reading 1 + Reading 2 + Reading 3] is stored as the first measurement saved in the memory.

Likewise the average of readings 4 - 6 are stored as the second measurement in the memory, etc.

The individual readings within the counted average (1.2.3, 4.5.6, etc.) are not saved.

Press **Batch/New Batch/Batch Type** and then select **Counted Average**.

The batch type can only be changed when creating a new batch.

The Elcometer 456 then asks the user to set the counted average value. Using the up and down arrow softkeys, set the counted average from 2 - 99 and press the **Ok** softkey.

This returns the user to the previous screen. Press the **Back** softkey to continue setting up the new batch as required before opening the new batch.

If Statistics are displayed whilst measuring using the counted average function (CAF) when taking the readings used to calculate the CAF measurement, the gauge will display the rolling statistical calculations of the individual readings until all the readings that go into calculating the CAF measurement are taken. At this point the statistics then display the values of the stored CAF measurements.



IMO PSPC: If you are inspecting coating thickness according to the International Maritime Organisations Performance Standard for Protective Coating, selecting the **IMO PSPC** batch type and then subsequently opening the batch, the gauge automatically:

- Asks the user to confirm the **NDFT** (nominal dry film thickness) value
- Sets the statistics to display the relevant IMO PSPC values
- Identifies the batch as an IMO PSPC batch for further analysis in the ElcoMaster 2.0 data management software

For more information on the IMO PSPC see page 74.

For more information on ElcoMaster 2.0 see page 35.

Fixed Batch Size (T)

When creating a new batch, by selecting **Batch/New Batch** and checking the **Fixed Batch Size** radio button, users can pre-define the number of readings that are to be stored into the batch (between 1 and 255) using the up and down arrow softkeys.

Once the batch has been opened and readings are being taken, the Elcometer 456 will notify the user when the fixed batch size is complete and ask if another batch is to be opened.

If the user selects No, then the gauge closes the batch and exits batching - returning the gauge to the Standard (Immediate) mode.

If the user selects Yes, then the gauge automatically:

- Appends a '_1' to the original batch name
- Opens a new batch - copying all the batch setup and calibration information
- The new batch is named as the original batch, with a '_2'

For example:

- A fixed batch is created and named "Component A".
- When the batch is full, a new fixed batch 'Component A_2' is created
- 'Component A' becomes 'Component A_1'

Appending the batch name in this way allows the user to quickly identify - or link - similar batches together.

Once a fixed batch size batch has been filled, no additional readings can be added to that batch; a partially completed fixed batch size batch, however, can be re-opened and completed at a later date.

To continue a batch link, press **Batch/Open Existing Batch** and select the last batch in the link. If the batch is full, the gauge will prompt the user to open a new batch before continuing. If the batch is partially complete the user can complete the batch before continuing to a new batch.

When downloading linked batches into ElcoMaster 2.0; the original batch name will be displayed (Component A in the above example). Selecting this batch name will download all linked batches into ElcoMaster 2.0 at the same time. For more information on downloading batches see page 44.

Note: Once a fixed batch size batch has been created and data has been stored into the memory, the user cannot rename the batch name within the gauge. The batch name can be amended using the ElcoMaster 2.0 software.

9 DOWNLOADING DATA USING ELCOMASTER 2.0 (BST)

Measurements from the Elcometer 456 Models B, S and T can be downloaded to a computer using the ElcoMaster 2.0 software (supplied with Model S and T gauges, downloadable from the Elcometer website for Model B gauges), or the older versions of ElcoMaster.

This instruction book explains how users can download data using ElcoMaster 2.0.

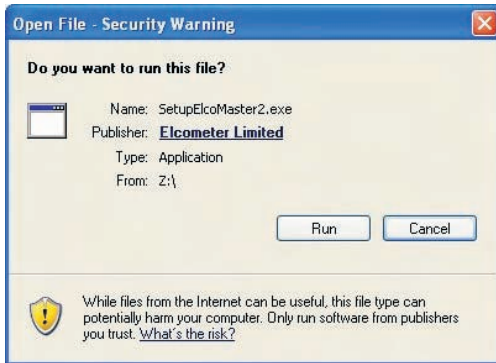

Installing ElcoMaster 2.0

To install ElcoMaster 2.0 insert the supplied mini-CD into your CD ROM drive. The software will automatically begin the install procedure.

If it does not, or you have downloaded the software from the Elcometer website, run the **SetupElcoMaster2.exe** file.



The ElcoMaster Setup Wizard will then begin.

Follow the on screen wizard

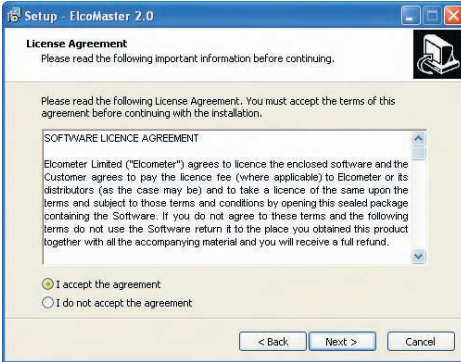

It is important to read the License Agreement carefully and if the terms are acceptable, select the 'I accept this agreement' radio button and click 'Next >'

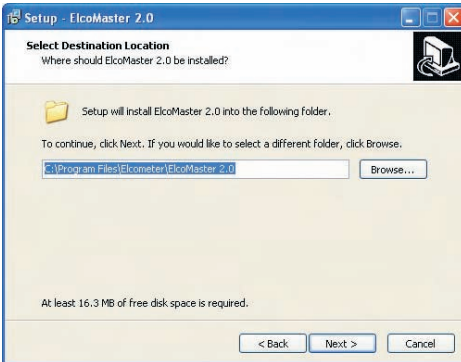

ElcoMaster 2.0 will automatically select a default destination location for the software to be installed.

Click the 'Browse...' button to select an alternate file location.

Click 'Next >' to continue

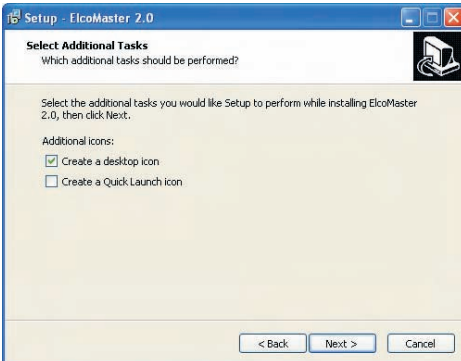

Choose any additional tasks, by selecting the appropriate check box and press 'Next >' to continue

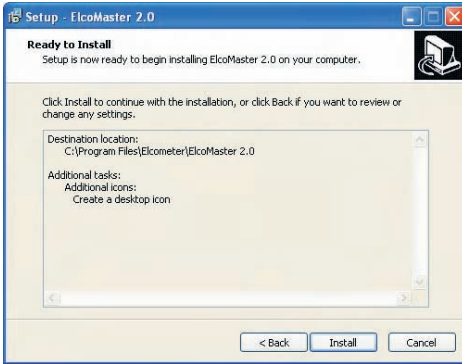

The ElcoMaster 2.0 wizard now provides a list of the settings that have been selected.

Click 'Install' to undertake the installation or '< Back' to review or alter any settings.

ElcoMaster 2.0 will now install.

Press 'Finish' to exit Setup.

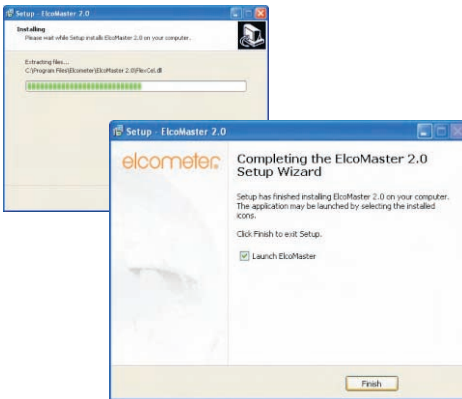

Upgrading data from older version of ElcoMaster

ElcoMaster 2.0 is fitted with an internal database upgrade facility which will automatically check to see if there are any original ElcoMaster database files and ask if the user would like to upgrade the data to the new ElcoMaster 2.0 format.

Upgrading can occur at any time by selecting Menu/Import/Import ElcoMaster 1.x Data and selecting the relevant database file.

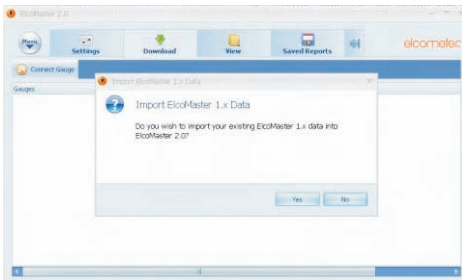

The ElcoMaster™ 2.0 Software



ElcoMaster™ 2.0 is a simple - yet powerful - data management software solution that has been designed to allow users to generate professional reports in seconds - with the minimum of fuss.

It has three operating modes; Excel Link, Standard and Advanced Mode. ElcoMaster™ is set to Standard Mode on first install.

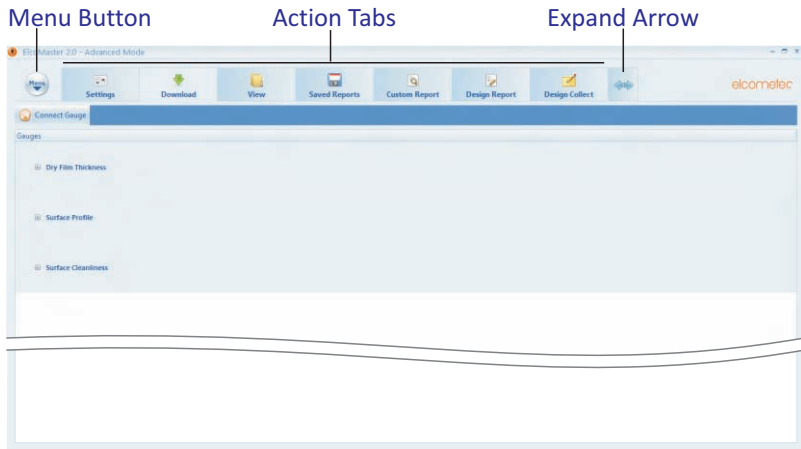
Across the top of the software is a Menu button, 'Action Tabs' and an expand arrow.



Pressing the **Menu** button opens up a drop down list of options:

- **Help** : Provides Elcometer contact details and information about ElcoMaster™ 2.0.
- **Update** : Provides users with:
 - the ability to update the ElcoMaster™ 2.0 software to the latest release - connection to the internet is required for this function.
 - the ability to upgrade the firmware of the:
 -  Elcometer 224 Digital Surface Profile Gauge (Model B & T)
 -  Elcometer 456 Digital Coating Thickness Gauge (Model B, S & T)
 -  Elcometer 130 Salt Contamination Meter (Model S & T)

- **Import:** Allows users to import a database from an earlier version of ElcoMaster™- version 1.x (not applicable to the new Elcometer 130)
- **Exit:** Allows users to shut down the software

The **Action Tabs** available depend on the operating mode in use as follows:

Excel Link Mode

- **Settings :** Allows users to adjust:
 - The *language* of ElcoMaster™ 2.0
 - The *units* of measurement by gauge type
 - Customise the default *reports* to include a user logo or image, together with footer information
 - Adjust the normal distribution type for the histogram *chart*
 - Alter the colour settings of the user *interface*
 - The text file separator used when *exporting* files
 - Select an alternate location to *store* the database
 - Enable or disable the *auto update* option (where access to the internet is prohibited).
- **Download:** Allows users to connect all their Elcometer gauges via USB, Bluetooth®, or RS 232 where appropriate.

Standard Mode: All the features of Excel Link Mode plus;

- **View:** Allows users to:
 - View measurement data, gauge information, measurement statistics, set limits, add notes and labels and view photographs and other documents
 - Print, email or PDF standard reports
 - Export data to Excel or other software packages as required
 - Archive (and restore) old data

- **Saved Reports:** Once a user has generated a PDF report from within the View action tab, the report is automatically saved within the Saved Reports action tab - for reference and review.

Advanced Mode: All the features of Excel Link and Standard Mode plus;

- Design custom reports
- View data in standard forms - predefined within the Design Report action tab or by Elcometer.
- Design a collection template to guide inspectors where, and in which order, readings should be taken - see page 46 for further details.

Users can switch between operating modes at any time by pressing the Expand Arrow and selecting the mode required.

en Connecting an Elcometer gauge to ElcoMaster 2.0 (BST)

In order to download any gauge readings from the Elcometer 456 the user must first 'Connect the gauge' by clicking the 'Connect Gauge' button on the Download action tab.

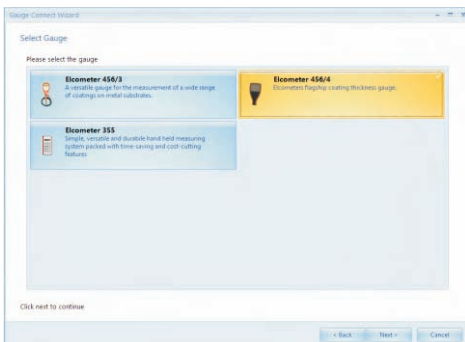
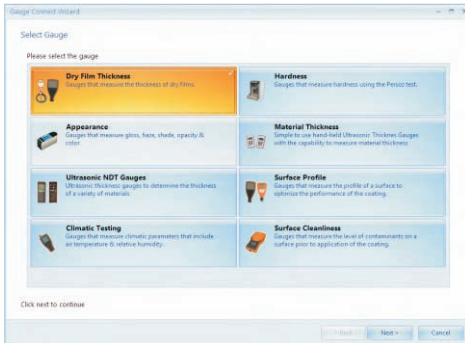
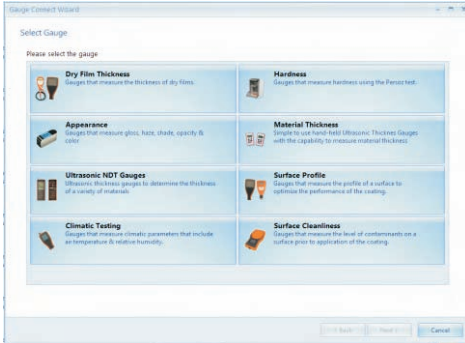

Clicking 'Connect Gauge' starts the ElcoMaster 2.0 Gauge Connect Wizard.

The ElcoMaster 2.0 data management software allows users to download readings from a wide range of Elcometer inspection gauges.

Measurements such as surface profile, surface cleanliness, temperature, dewpoint, delta T, gloss, material thickness and dry film thickness can all be downloaded, stored and reported using the ElcoMaster 2.0 software.

These instructions will inform the user how to download data from an Elcometer 456 coating thickness gauge. All appropriate Elcometer gauges can be downloaded in a similar way.

- Select the Dry Film Thickness tab and press 'Next >'

ElcoMaster 2.0 supports the new Elcometer 456 (identified in the software as Elcometer 456/4) and the Elcometer 456 Mk 3 (Elcometer 456/3).

- Select the Elcometer 456/4 tab and press 'Next>'

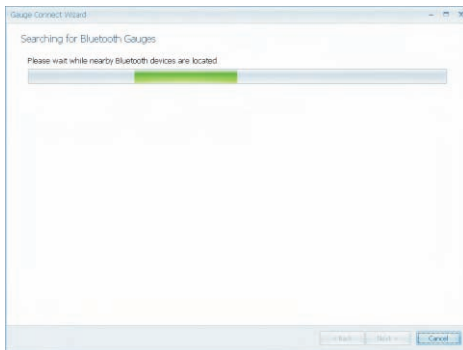
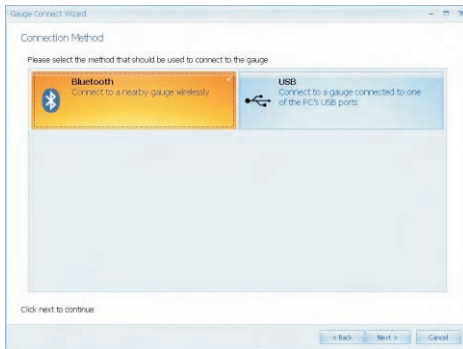
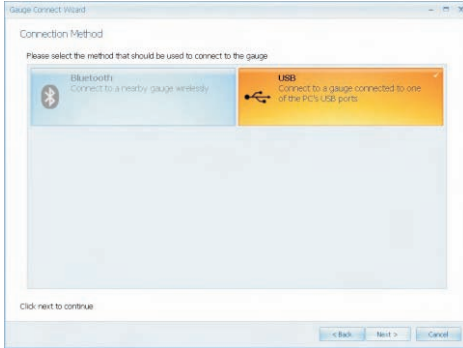

- Select the appropriate connection method for the gauge

Elcometer 456 gauges come supplied with Bluetooth (Models S & T) and USB (Models B, S & T) data output.

Users can purchase a USB Bluetooth Adaptor from Elcometer (Part number T99920130) which will provide a Bluetooth solution to computers without internal bluetooth fitted.

If ElcoMaster 2.0 is installed onto a computer without Bluetooth capability, however, the Bluetooth tab is greyed out (as displayed in top image).

- Select the appropriate connection method
- Switch on the Elcometer 456
- Connect the USB cable or make sure that Bluetooth is switched on in the gauge via **Menu/Bluetooth/Enable Bluetooth (S & T)**
- Bluetooth users should return their gauge to the main reading screen before continuing
- Press 'Next >'
- After a screen prompt ElcoMaster 2.0 will search for and list all Elcometer 456 gauges.

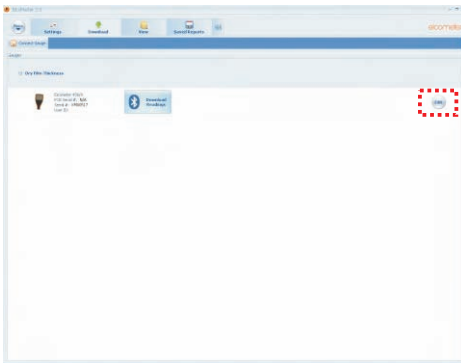
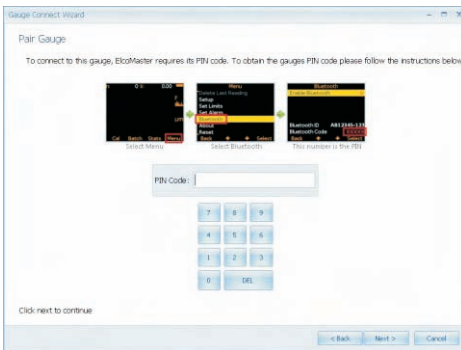
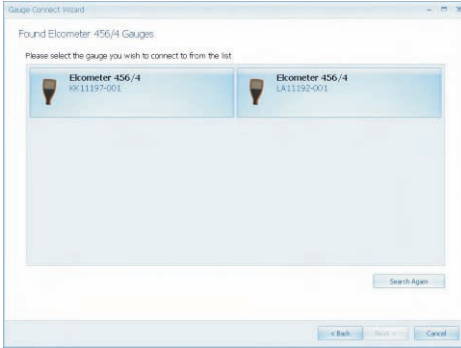

Each coating thickness gauge connected is now listed.

- Select the appropriate gauge and press 'Next >'

If connecting via Bluetooth, the gauges are identified using the Bluetooth ID - which can be seen on the bottom of the **Menu/Bluetooth** screen.

Connecting via bluetooth now requires the gauge to be 'Paired' by keying in the gauge's unique Bluetooth PIN Code. This code can be found on the bottom of the **Menu/Bluetooth** screen.

- Type in the Bluetooth PIN Code and press 'Next >'

ElcoMaster 2.0 will now validate the connection, press Finish when complete.

The gauge is now connected and ElcoMaster 2.0 will return the user to the Download action tab, and display the connected gauge.

The same gauge can be connected by more than one method. Repeat the 'Connect Gauge' and follow the on screen prompts.

By clicking on the **Edit** button, users can Delete the gauge from ElcoMaster™ 2.0, name the gauge by a more familiar identification (Enter a User ID) or set up the gauge power up display screen (Change the Welcome screen). See Changing the Welcome Screen on page 64.

Downloading Data from the Elcometer 456 (ST)

Once the gauge has been connected to ElcoMaster 2.0 (see pages 41-43), switch on your gauge and click the 'Download from Gauge' button for the relevant gauge and connection method.

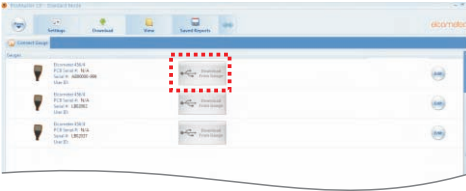

The Download Wizard will now guide the user through the simple download readings process.

ElcoMaster™ 2.0 allows users to download their gauge readings:

- Directly into ElcoMaster™ 2.0
- Directly into an Excel Spreadsheet, bypassing ElcoMaster 2.0
- into a text file for use in other software programs, or
- into a CQATK XML file

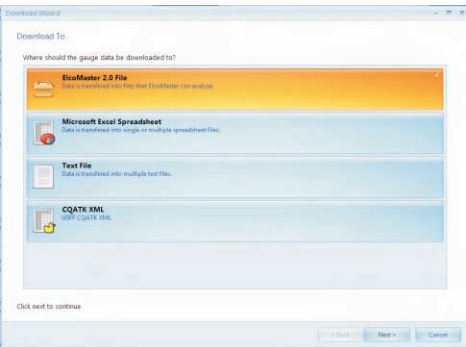

- Select the appropriate option
- Select or create a new project folder as required (ElcoMaster Batch File users)

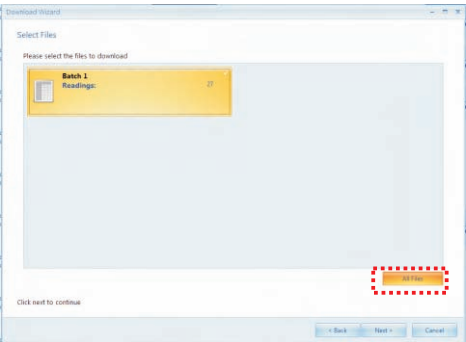

Users wishing to export directly into Excel will also be asked to select a single or multiple spreadsheet option. Single; all batches selected will be downloaded into a single spreadsheet. Multiple; each batch will be downloaded into a separate spreadsheet tab.

- Select one or more individual batches or click on 'All Files' and press 'Next>'

When downloading data into ElcoMaster™ 2.0 (as opposed to directly into a spreadsheet or a text file), downloaded data is stored in Projects - allowing users to clearly identify inspections.

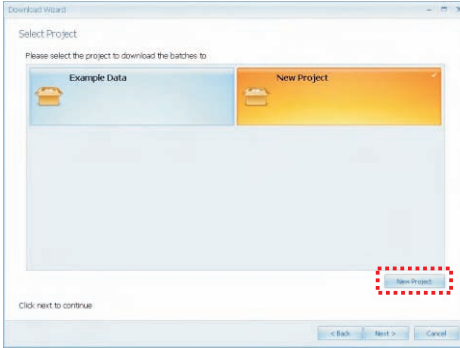

The User will be asked to select a project name from the list. Alternatively the user can create a New Project name.

- Select or create a new project and press 'Next >'

To download readings from the gauge:

- Select a single or multiple batches from the list or click on 'All Files' as required, then press 'Next >'

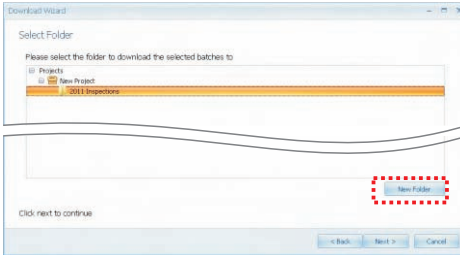

- Select or create a new folder to save the gauge's data to

In some cases users may have re-used an existing batch name in the gauge. The user should now chose either to select:

- Rename Duplicate Files
- Rename All Files, or
- Overwrite Existing Files
- Select as required and press 'Next >'

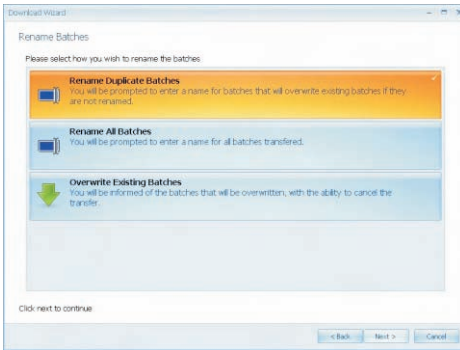

The selected batches will now download. Once the data download has been completed, the user can check the 'View Files' box and click 'Finish'.

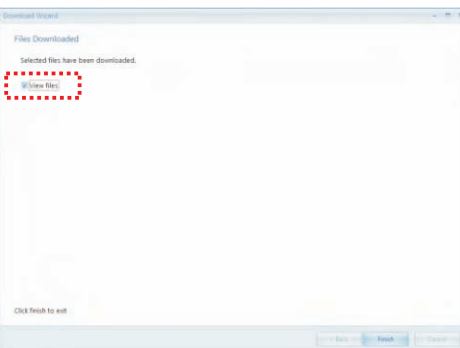

Alternatively, click 'Finish' and select the 'View Action Tab'

Viewing Data in ElcoMaster 2.0

ElcoMaster 2.0 not only allows users to view and analyse data from a wide range of Elcometer gauges, but also allows users to manually input data as required.

This instruction book provides a brief summary of some of the features of ElcoMaster 2.0, however users should read the ElcoMaster 2.0 help file for a complete guide.

The screenshot displays the ElcoMaster 2.0 Standard Mode interface. At the top, there are three tabs: **Data Tree**, **Command Tabs**, and **Template Tabs**. The **Data Tree** on the left lists various project and batch items, with **Batch 4** selected. The **Command Tabs** include Settings, Download, View, and Saved Reports. The **Template Tabs** include New, Print, PDF, Email, and Report. Below the Data Tree is the **Live Reading Tab**, which contains a 'Connect Gauge' button and instructions for taking live readings. The **Measurement Data Window** is located below the Live Reading Tab and displays a table of gauge and probe details. The **Graph Window** is the largest central area, showing a line graph of Thickness (µm) versus Reading Number.

Gauge	
Type	Elcometer 456/4
PCB Serial #	
Serial #	AB00000-999
User ID	
Probe	
Type	F2
Serial #	KL02152
Batch	
Name in Gauge	Batch 4
User ID	Batch 4
Created Date	22/02/2012 14:34:24
Updated Date	22/02/2012 14:34:24
First Reading Date	22/02/2012 14:34:28
Last Reading Date	22/02/2012 14:34:42
Rule Check	
Method	None

By selecting the View Action Tab, users can instantly see their data. The View Action Tab can be broken down into 6 distinct areas:

- **Data Tree** Batches can be stored within folders (📁) in unique Project files (📁).

By clicking on the Project filename, users can then complete unique project tags and batch tags as required.

Each batch of data is identified by the type of inspection:

- 🌡️ Climate Batch
- 🏠 Surface Profile Batch
- 💧 Surface Cleanliness Batch
- 🇺🇸 Dry Film Thickness Batch
- 📄 Material / Ultrasonic NDT Batch

Clicking the computer mouse's right button over a file or folder provides the user with the following functions:

- **New:**
Allows users to:
 - create a new **Project** (📁)
 - create a new **Folder** (📁)
 - import an **Image** (🖼️)
 - import a PDF **Document** (📄)
 - create a new batch type
- **Cut, Copy & Paste:**
Cut, copy & paste inspection files and folders into other files or folders within the data tree.
- **Delete, rename & move to:**
Allows delete, rename or move a file
- **Combine & Split:**
Combine batches of the same type or split a batch into equal sizes or of equal time
- **Archive & Restore:**
Archive and restore inspection data
- **Print, PDF, Email & Export:**
Print, generate a PDF or export to Excel or a tab separated text file; the selected batch report

• Command Tabs

There are 6 command tabs, which are the key functions required by the user.



New:

Allows users to:

- create a new **Project** (📁)
- create a new **Folder** (📁)
- import an **Image** (🖼️)
- import a PDF, .edf, .txt. **Document** (📄)
- create a new batch type



Move to:

Moves the selected items to a different folder or to a different page



Print:

Prints a report of the selected items



PDF:

Generates a PDF report of the selected items



Email:

Generates a PDF report of the selected items and attaches it to an email



Export:

- Allows the user to export the selected items into Excel or as a text or CQATK XML file

• **Template Tabs & Graph Window**

There are currently 2 graphs within ElcoMaster 2.0; individuals and histogram. Clicking a template tab displays the relevant graph in the **Graph Window**

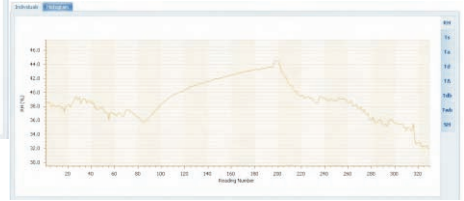
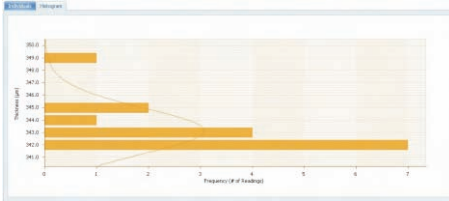

When the Individuals Graph is displaying climate data, additional tabs appear on the right hand side, allowing the user to select a measurement to view from the following:

- RH: Relative Humidity
- Ts: Surface Temperature
- Ta: Air Temperature
- Td: Dewpoint Temperature
- TÄ: Delta T, (Ts-Td)
- Tdb: Dry Bulb Temperature
- Twb: Wet bulb Temperature
- SH: Specific Humidity

Right mouse click on the individuals graph allows users to select the x-axis value between:

- Date & Time
- Relative Time (seconds)
- Reading Number
- Relative Time (minutes)

Left clicking and dragging the mouse across the individuals chart allows users to zoom in on a specific area of the graph. The zoom can be reset by clicking on the  icon.

- **Measurement Data Window**

The measurement data window provides the user with a range of information under 7 tabs:

- **Details**

Provides useful information about the measurement gauge, serial number, batch name, date the batch was created, date and time of the first and last reading, etc.

- **Statistics**

Provides the user with a wide range of statistical calculations - mean, minimum and maximum reading, standard deviation, $\pm 3\sigma$, coefficient of variation, relevant information regarding the IMO PSPC analysis (coating thickness gauge readings only).

Users can display the values on the graph by clicking the () icon and selecting a colour.

- **Measurements**

Displays all the individual readings. Users can alter the display order (Date & Time, Relative Time (seconds), Relative Time (minutes) and Reading Number) by clicking on the column title.

Individual measurements can be excluded/ included by right clicking on the specific measurement within the table. Measurements can also be amended by overtyping the relevant reading.

Comments can be added to any measurement by clicking on, and then typing into, the relevant cell within the comments column.

- **Limits**

Shows any limits that were used whilst taking the readings or allows users to apply limits. When set, measurements outside the limits are highlighted within the measurement tab.

Users can display the values on the graph by clicking the () icon and selecting a colour.

- **Measurement Data Window (continued)**

- **Notes**

Type and format a comment or note regarding the batch.

- **Labels**

When a project has been set up with individual Project and Batch labels users can amend or input the appropriate details. Project labels are applied to each file, folder and batch within the project; Batch labels apply to a specific batch. Both project and batch labels are fully user definable, however examples of project and batch labels are listed below:

Project Label Examples:

Client name, Structure name, Structure location,

Batch Label Examples:

Inspector name, shift number, area under consideration, strutt number, etc.

- **Photos**

Photographs of the area under inspection, specific defects, etc can be attached to the measurement batch - simply by clicking the () icon within the Photos tab.

Descriptions or comments can be added below each image added.

Double clicking on any photo opens up a view window allowing the user to copy the photo to clipboard (for pasting in another program, or save the photograph to another file.

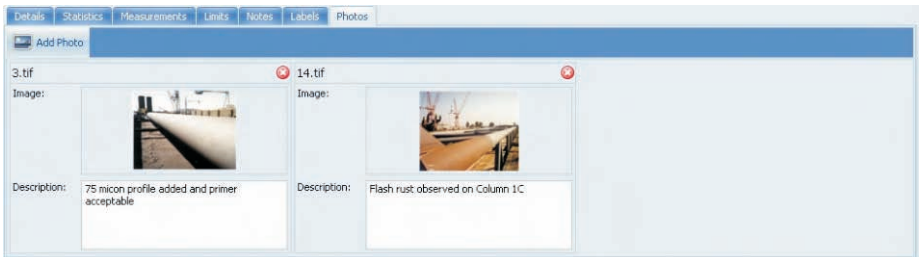

Data, photographs, labels etc. added within the measurement window tabs is automatically included on any reports, exports, pdf and emails generated.

• **Live Gauge Readings (BST)**

ElcoMaster 2.0 allows users to transfer data from a gauge as the readings are taken, to be stored in a batch within ElcoMaster 2.0.

Live gauge readings can be recorded via Bluetooth (ST) or USB (BST) connections

Once the gauge has been connected to ElcoMaster 2.0 (see pages 41-43), switch on your gauge and click the 'Live Readings' button on the View Action Tab

- Select the appropriate batch (or create a new batch) for the readings to be recorded into

ElcoMaster™ 2.0 will now open up the Live Readings display, and ask the user to 'Connect Gauge'

- Click on the Connect Gauge
- Select a gauge from the list
- Select the relevant connection method (if more than one connection method has been set up (see pages 41-43)

ElcoMaster™ 2.0 will then link with the selected gauge and, when ready display the gauge information within the Live Readings window.

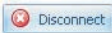
- At any time the user can select a different batch to change where the next reading is taken.
- Click the  button or switch of the gauge to disconnect

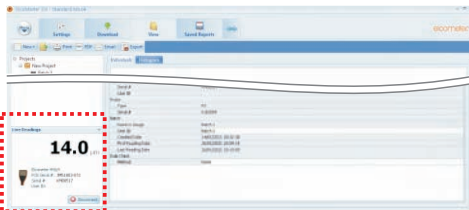
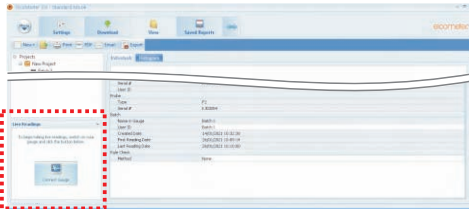
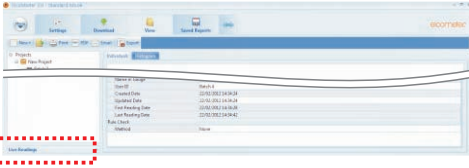

• **Design Collect**

The ‘Design Collect’ function allows users to set up a collection template to guide Inspectors where, and in which order, readings should be taken. This image can be used as a collection guide in ElcoMaster™ 2.0[†] or transferred to an Android mobile phone or tablet using ElcoMaster™ for Android™, see pages 55 - 56.

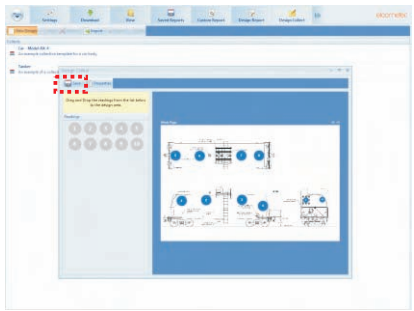
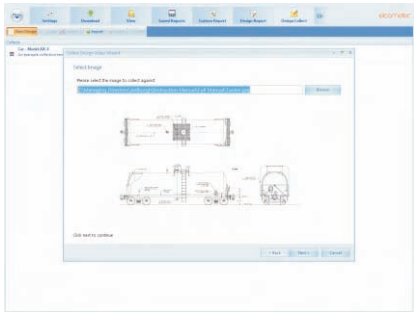
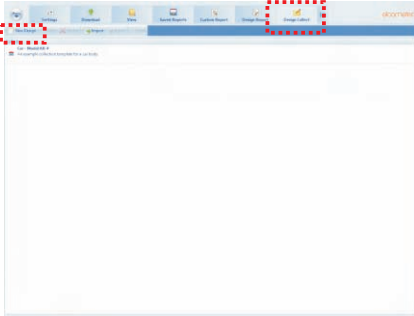

- Click on the Design Collect tab and select an existing template or click ‘New Design’

When creating a new design you will be asked to:

- Enter a name and description
- Select the Batch Type; Profile, Material Thickness, DFT or Surface Cleanliness
- Add the required image to collect readings against
- Specify the number of readings to be collected
- Enter relevant Limits
- Request a prompt to begin the next set of readings or begin automatically
- Choose to create a new batch for each set of readings or create a single batch with multiple reading sets

- Click ‘Finish’ to begin the design

To design the ‘collect’ image sequence, simply click and hold each ‘reading’ circle in turn, drag onto the image where readings are to be taken and adjust the size accordingly.

Once complete click ‘Save’ and click the ‘X’ button in the top right to close the design window.

[†] To use Design Collect, switch ElcoMaster™ 2.0 to Advanced Mode by clicking on the Expand Arrow, and selecting ‘Start Advanced Mode’.

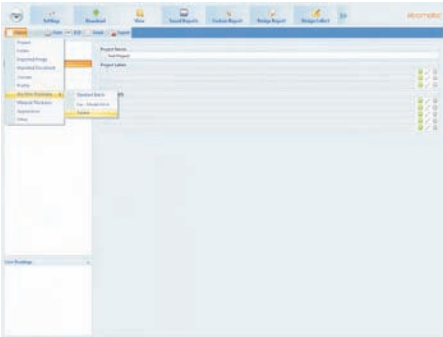

Using a Collect Design

- Select the 'View' tab
- Select a folder or project and click the 'New' button
- Move the cursor to relevant batch type, an additional window will appear, select the required Collect Design

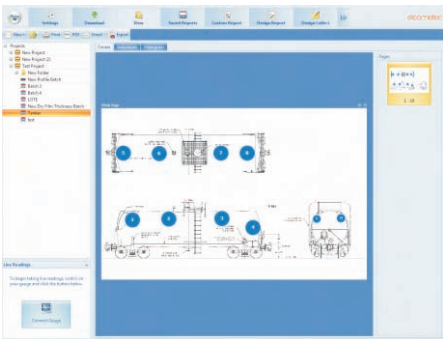

A new batch will be created. Unlike standard batches it will have an additional tab with the same name as the Collect Design, click on this to show your design. To begin collection,

- Click on 'Connect Gauge' in the 'Live Readings' window
- Select a gauge from the list^a
- Select the relevant connection method



ElcoMaster™ 2.0 will link the selected gauge and, when ready, display the gauge information within the Live Readings window.

Once connected, green arrows will flash around the first 'reading' circle to measure. When a measurement is taken, the 'reading' circle will change to show the measured value^b, and the green arrows will move to the next reading.

^a The gauge must be connected to ElcoMaster™ 2.0 before it will appear in the list, see pages 41 - 43.

^b The 'reading' circle will be green if the measurement is within set limits and red, if outside limits.

10 ELCOMASTER MOBILE (ST)

ElcoMaster™ Mobile is free software for use on all smart phones and tablets running Android 2.1 or above.

- Compatible with Bluetooth versions of the:
 - Elcometer 130 Salt Contamination Meter
 - Elcometer 224 Surface Profile Gauge
 - Elcometer 319 Dewpoint Meter
 - Elcometer 456 Coating Thickness Gauge

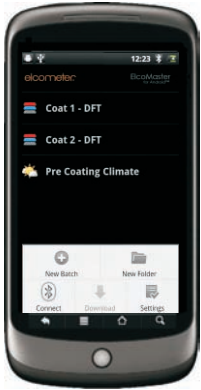

- Store live readings directly on the phone and save them into batches.
- Download batches straight to a mobile phone or tablet, allowing data analysis immediately on site.
- Transfer inspection data from mobile to PC for further analysis and reporting.



- Analyse data via sequential readings, statistics, charts & histograms or on images.



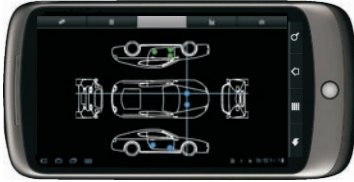

- Download collection images created using the 'Design Collect' function in ElcoMaster™ 2.0 to indicate where and in which order readings should be taken.

- Take photographs and add them to batch readings at the click of a button.



- Map readings on to a Google Map, photographs or diagrams.

Installing ElcoMaster™ Mobile

To install ElcoMaster™ Mobile simply scan the QR code or download via www.elcometer.com or Google Play, <https://play.google.com/store/apps/details?id=com.elcometer.elcomaster>, and follow the on screen instructions.



11 CLOUD COMPUTING WITH ELCOMASTER 2.0 (ST)

ElcoMaster 2.0 is now compatible with Cloud Computing.

- Create a Cloud account via a Cloud service provider e.g. Dropbox, Google Drive™, Skydrive or your own cloud based FTP server.
- All approved users of the cloud account will have instant access to all inspection data in real time.
- Data can be accessed by authorised users via secure log-in from any computer or mobile device anywhere in the world via Bluetooth®, USB, WiFi or 3G/4G.
- Using the ElcoMaster™ instant messaging feature, job instructions can be sent or stored in specific job files.
- Wherever you are in the world, ElcoMaster™ Mobile allows you to instantly upload to the cloud via 3G/4G or WiFi.



12 GETTING THE MOST OUT OF ELCOMASTER 2.0

ElcoMaster has been designed to be a very intuitive method of developing professional reports, it is however extremely versatile. Here are just a few ways ElcoMaster™ can be used in the day-to-day activities of a coating professional.

1. Gauge to PC to Excel



Transferring inspection data straight into Microsoft Excel via Bluetooth® or USB is simple and easy.

2. Gauge to PC data transfer into ElcoMaster™ 2.0



Using Bluetooth® or USB, ElcoMaster™ transfers inspection data in seconds, archiving data and generating reports at the click of a button.

3. ElcoMaster™ Mobile App for immediate data transfer from site to office



Transfer inspection data straight to mobiles and tablets via Bluetooth® when on site for instant analysis, then e-mail them back to the office for storing, review and QA reporting.

4. Upload to a cloud for real time analysis anywhere



Using ElcoMaster™ Mobile App you can upload inspection data, photos, notes and GPS coordinates direct to a Cloud account of your choice via 3G/4G or WiFi.

All data is instantly visible to other approved users of the account - through a secure log-in on any computer or mobile device anywhere in the world.

5. Seamlessly link multiple sites or production lines



ElcoMaster™ 2.0 gives you real time quality control monitoring from multiple inspection projects in any location. You can compare and combine inspection data from different production lines or different locations, to produce specific Project Inspection Reports quickly and easily.

6. Real time collaboration for multi-site projects

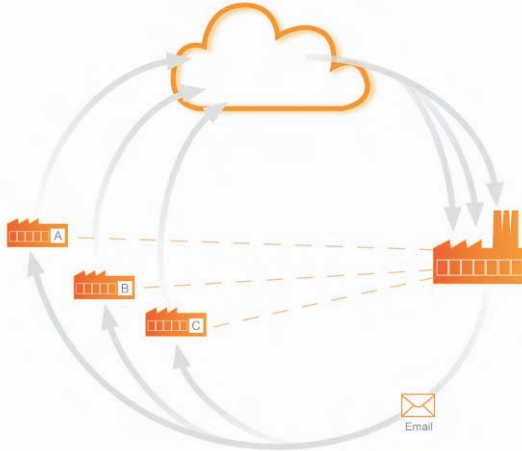

Real time collaboration for multi-site projects

When working with manufacturers of sub-assemblies across the globe ElcoMaster™ can collate all inspection data from each site, assembly line and project into one shared location.

Contractors can then:

- Accept or reject parts before shipment from sub-assembly plants.
- Combine all data from sub assembly and final assembly inspection to generate Project Inspection Reports for quality management, both during and after completion of the project.
- Have real time in progress visibility across the whole project, no matter where the sub-assembly manufacturing is in the world.
- Have multi-site collaboration, real time dialogue and decision making to improve efficiency and quality throughout the production process.

Real time communication

Featuring instant messaging the ElcoMaster™ Mobile App lets you add messages to inspection data, projects and files, allowing you to immediately discuss key points with your colleagues, managers or clients, send work instructions and store messages within the project file.

Your data - your choice - your control

ElcoMaster™ 2.0 allows you to decide which Cloud service provider to use. It is your data, it is secure as only approved users can have access, no third parties can see your data.

ElcoMaster™ Mobile App is compatible with a range of cloud service providers and FTP servers including: Google Drive, FTP Server, Dropbox.

13 CALIBRATING THE ELCOMETER 456 (EBST)

The Elcometer 456 gauge is available in 4 model versions. Each version has a number of calibration methods as below:

Method	Model E	Model B	Model S	Model T
Factory				
Rough / 2 Point				
Zero				
Smooth				
Zero Offset				
Auto				

For full descriptions of each calibration method please see page 19-20.

The Elcometer 456 has on screen instructions to guide the user through each calibration method.

Calibrating the Elcometer 456 (Model E)

Press the **Cal** softkey and follow the on screen instructions.



To calibrate the Elcometer 456 Model E on rough surfaces:

- Select two foil values - one above the target dry film thickness value (thick) and one below (thin)
- Follow the on screen instructions
- more than one reading can be taken on each foil value - the average of the readings is displayed (screens c and g on page 60).
- **To calibrate the Elcometer 456 Model E on smooth surfaces:**
 - Select a foil value which is above the target dry film thickness value (thick) and the uncoated base substrate (thin).
 - When the gauge instructs the user to place the gauge onto the thin foil (calibration step 2), place the probe on the uncoated base and adjust the thickness value to 0.0µm (mils)

To calibrate the Elcometer 456 Model E using the Factory calibration:

- Select either **Menu/Reset/Metric Gauge** or **Menu/Reset/Imperial Gauge**.

Taking multiple readings on each foil will increase the accuracy of the calibration.

Calibrating the Elcometer 456 (BST)

- Press the **Cal** softkey to open the Calibration menu
- As the Elcometer 456 Model B, S and T have multiple calibration methods;
 - if the Calibration Method icon displayed is as required, press the **Select** softkey and follow the on screen instructions
 - the user can amend the calibration method, by selecting the appropriate method from within the **Cal/Cal Method** menu and press the **Select** softkey before selecting **Calibrate** from the Calibration menu

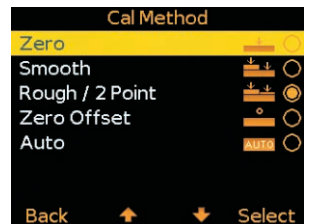
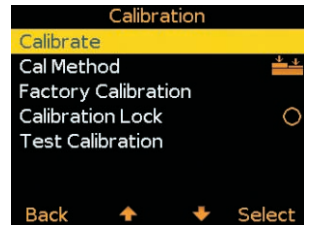

- to select the factory calibration press **Cal/Factory Calibration**
- The factory calibration returns the gauge to the calibration set up during manufacture and final test. The factory calibration is a smooth surface calibration using factory reference probes
- When the correct calibration method has been selected, press Cal/Calibrate and follow the on screen instructions.
- Taking multiple readings on each foil will increase the accuracy of the calibration.

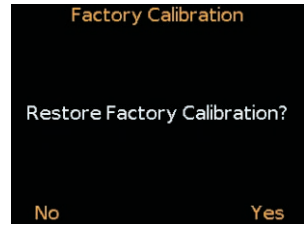

Note: Auto, ISO, SSPC PA2, Swedish and Australian cal methods - where available - can only be selected whilst in batching as memory is required.

Testing (BST) & Validating (ST) Calibrations

- The calibration of any Elcometer 456 B, S or T gauge can be checked at any time, without affecting any statistics or batch memory.
- By selecting **Cal/Test Calibration** the user can check the calibration of the gauge by comparing the reading value displayed versus the measured foil or coated standard value. (ST)
- Pressing the **Validate** Softkey will update the date and time of the last calibration. (ST)

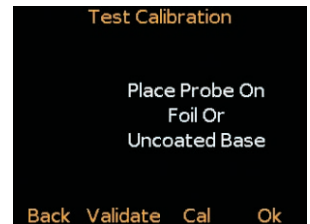
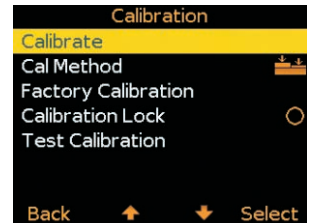

Each batch can have its own unique calibration, simply calibrate each batch independently. For more information on Batching see page 23.

en Calibration lock (BST)

To avoid accidental amendments to the calibration settings switching on the **Cal/Calibration Lock** feature[†] locks[†] the user from undertaking any changes to the calibration without first un-checking the **Cal/Calibration Lock** feature.

When the Calibration Lock is enabled, users can still test the calibration via **Cal/Test Calibration** but will be unable to validate or re-calibrate the gauge.

The calibration can also be locked using a PIN Code.

Locking & Unlocking the Calibration Lock using a PIN Code (BST)

To set a calibration lock PIN code:

- Press the **Menu** softkey and select **Setup/Calibration Lock**
- Set the four digit PIN Code using the **↑↓** softkeys to select 0 to 9 and the **→** softkey to move from the first to the fourth digit[†]
- Press Set, Escape to cancel or Adjust to amend the PIN code

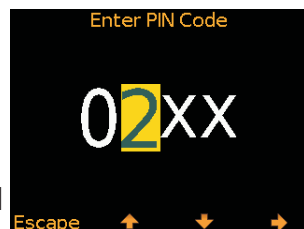

To unlock the calibration:

- Press the **Cal** softkey and select **Calibration Lock**
- Enter the four digit PIN Code, if set, using the **↑↓** softkeys to select 0 to 9 and the **→** softkey to move from the first to the fourth digit[†]
- Press Ok or Escape to cancel

To disable the calibration lock PIN Code:

- Press the **Menu** softkey and select **Setup/Calibration Lock**
- Enter the four digit PIN Code
- ▶ Should the user forget or lose the PIN code, the PIN can be disabled via ElcoMaster™ 2.0. Using the USB cable, simply connect the gauge to a PC with ElcoMaster™ 2.0 Version 2.0.34 or higher installed and select Edit/Clear Calibration PIN.

[†] The **→** softkey will appear when the “ X “ changes to a number.

14 CHANGING THE WELCOME SCREEN (BST)

Each time the Elcometer 456 gauge is switched on, the Elcometer logo is displayed. Users can add their own logo, image or identification details as required via ElcoMaster 2.0.

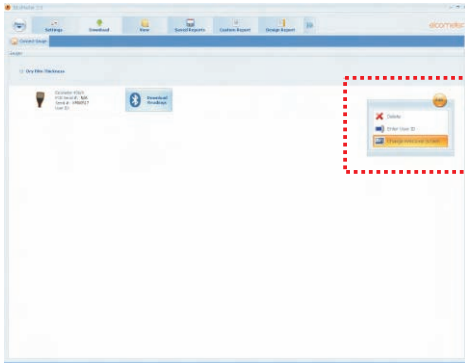

Once the gauge has been connected to ElcoMaster 2.0 (see pages 41-43), to add a user welcome screen

- Switch on your gauge
- Select the Download Action Tab
- Click the 'Edit' button on the right hand side of the appropriate gauge
- Select 'Change Welcome Screen' from the drop down menu
- Select the required image, and or add user specific text and press 'Next >'
- Select 'Stretch Image' or 'Centre Image' as required and press 'Next >'
- Select the appropriate connection method and press 'Next >'

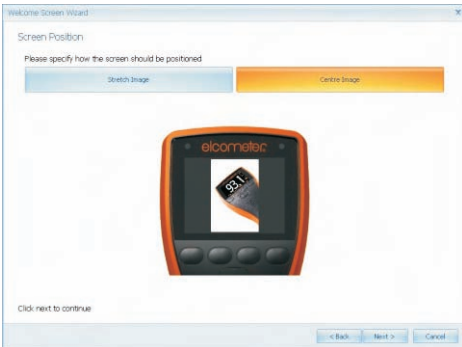

ElcoMaster 2.0 will now download the selected image into the gauge. This may take some time.

15 GAUGE FIRMWARE UPDATES (BST)

Each time the Elcometer 456 gauge is connected to ElcoMaster 2.0 (see pages 41-43); if the computer has access to the internet, ElcoMaster 2.0 automatically checks to see if there are any gauge firmware updates for the connected gauge.

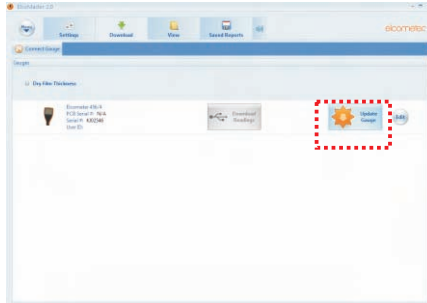

ElcoMaster 2.0 will inform the user when there are any firmware updates available for the connected gauge by displaying the 'Update Gauge' button.

Please note that users can update the gauge firmware via a USB connection only.

Clicking the 'Update Gauge' button will display a list of the 'Fixes' in all the updates that have been released since the gauge's last upgrade.

- Press 'Next >' to continue.

Warning - updating the gauge firmware will result in all readings, batches, statistics and calibrations being deleted. The gauge will also be returned to the factory default settings.

- Press 'Next >' to commence downloading the latest firmware to the Elcometer 456

Warning - Do not switch off the computer or disconnect the gauge during the gauge upgrade.

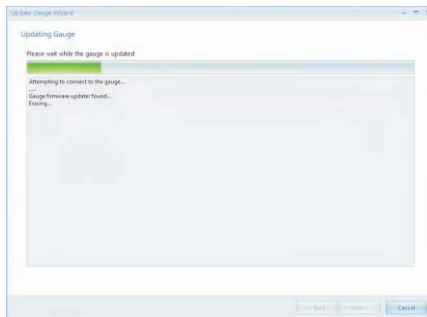
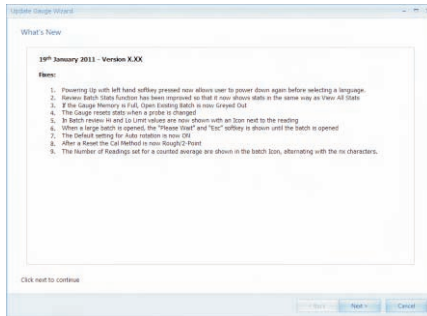





Typical firmware updates include gauge enhancements, amendments, language updates, etc. Users cannot upgrade a Model B to a Model S for example, nor can a ferrous gauge be upgraded to a dual ferrous/non-ferrous gauge.













16 GAUGE ICONS & ERROR CODES (EBST)



Icon	Description	Model
n:	Number of Readings	BST
\bar{x}:	Mean (average)	BST
σ:	Standard Deviation	BST
Hi:	Highest Reading	BST
Lo:	Lowest Reading	BST
CV%:	Coefficient of Variation	BST
EIV:	Elcometer Index Value (EIV)	BST
NDFT:	NDFT Value (Nominal Dry Film Thickness)	ST
%\geqN:	Percentage of readings greater than or equal to the NDFT Value	ST
%$\frac{90}{100}$:	Percentage of readings between 0.9 x NDFT and the NDFT value	ST
90:10:✓	90/10 Rule Pass	ST
90:10:✗!	90/10 Rule Fail: 90% of readings are greater than the NDFT value	ST
90:10:✗	90/10 Rule Fail: At least one measurement is below 0.9 x NDFT. (If a number between 1 and 10 is displayed, insufficient measurements have been taken to be statistically valid)	ST
$n\bar{x}$	Counted Average (when not in Batching)	BST
$\frac{\updownarrow}{\updownarrow}$	High and Low Limit Set	ST
$\frac{\downarrow}{\downarrow}$	Low Limit Set	ST
$\frac{\uparrow}{\uparrow}$	High Limit Set	ST
$\frac{\uparrow}{n}$	Number of readings above Limit	ST
$\frac{\downarrow}{n}$	Number of readings below Limit	ST

Measurement Modes





Icon	Description	Model
	Low Limit Set: Reading outside Low Limit	ST
	High Limit Set: Reading outside High Limit	ST
	Low & High Limit Set: Reading outside Low Limit	ST
	Low & High Limit Set: Reading outside High Limit	ST

Calibration









Icon	Description	Model
	Zero Calibration Method	BST
	Smooth Surface Calibration Method	BST
	Rough/ 2 Point Calibration Method	EBST
	Zero Offset Calibration Method	ST
	Auto Calibration Method	ST
	ISO 19840 Calibration Method	ST
	SSPC PA2 Calibration Method	ST
	Swedish Standards Calibration Method	ST
	Australian Standards Calibration Method	ST
	Calibration Check	T
	Reading outside Calibration	T
	Calibration Lock	BST

Icon	Description	Model
	Auto Repeat Mode	T
	Scan Mode	T
	Scan Mode with Hold	T

Batching

Icon	Description	Model
	Batch Type: Normal	ST
	Batch Type: Counted Average	ST
	Batch Type: IMO PSPC	ST
	Deleted Reading - Tagged	ST

General

Icon	Description	Model
	Bluetooth Not Connected	ST
	Bluetooth Connected	ST
	USB Connected	BST
F	Ferrous Probe on Ferrous Substrate	EBST
N	Non-Ferrous Probe on Non-Ferrous Substrate	BST
FNF	Dual FNF Probe on Ferrous Substrate	EBST
fNF	Dual FNF Probe on Non-Ferrous Substrate	EBST
	Battery Life Indicator	EBST
	Replace Batteries	EBST
	User Selectable Feature: Switched Off	EBST
	User Selectable Feature: Switched On	EBST
	Beep Volume Setting	EBST

Error Codes

Under certain conditions, the gauge will display error messages. These message are cleared by pressing any key. The cause of the error should be corrected before proceeding.

Message	Cause / Action
#1 - Probe	Probe to gauge communication failure. Integral Gauges: Contact Elcometer. Separate Gauges: Remove probe and refit. If error persists, contact Elcometer.
#2 - Probe	Corrupt data output from probe. Integral Gauges: Contact Elcometer. Separate Gauges: Replace probe. If error persists, contact Elcometer.
#3 - Probe	Internal Error - contact Elcometer.
Probe Unsupported	No probe connected. Connect probe. Probe is Dual FNF but gauge is ferrous or non-ferrous only or Mk 3 probe is being used with a Mk 4 gauge. Use correct probe.
Probe Changed	Probe has been changed during a calibration procedures. Calibration adjustment required.
Unstable Reading	External electromagnetic interference or gauge is faulty. Isolate from electromagnetic interference. If error persists, contact Elcometer.
Value Too Large	Calculated value is too large to be displayed. Contact Elcometer.
Calibration Error	Incorrect calibration calculation. Re-calibrate. If error persists, contact Elcometer.
Bluetooth PC Reply	Bluetooth link working at limit of its range. PC is busy running other applications. Interference. PC application doesn't send replies. Move gauge closer to PC. Shutdown other applications. Remove source of interference. If error persists, contact Elcometer.
Error - EEPROM Write	Gauge EEPROM communication error. If problem persists, EEPROM is faulty.

17 GAUGE MENU STRUCTURES (EBST)

Please find below a simplified diagram of each Elcometer 456 model's menu structures.

Elcometer 456 Model T

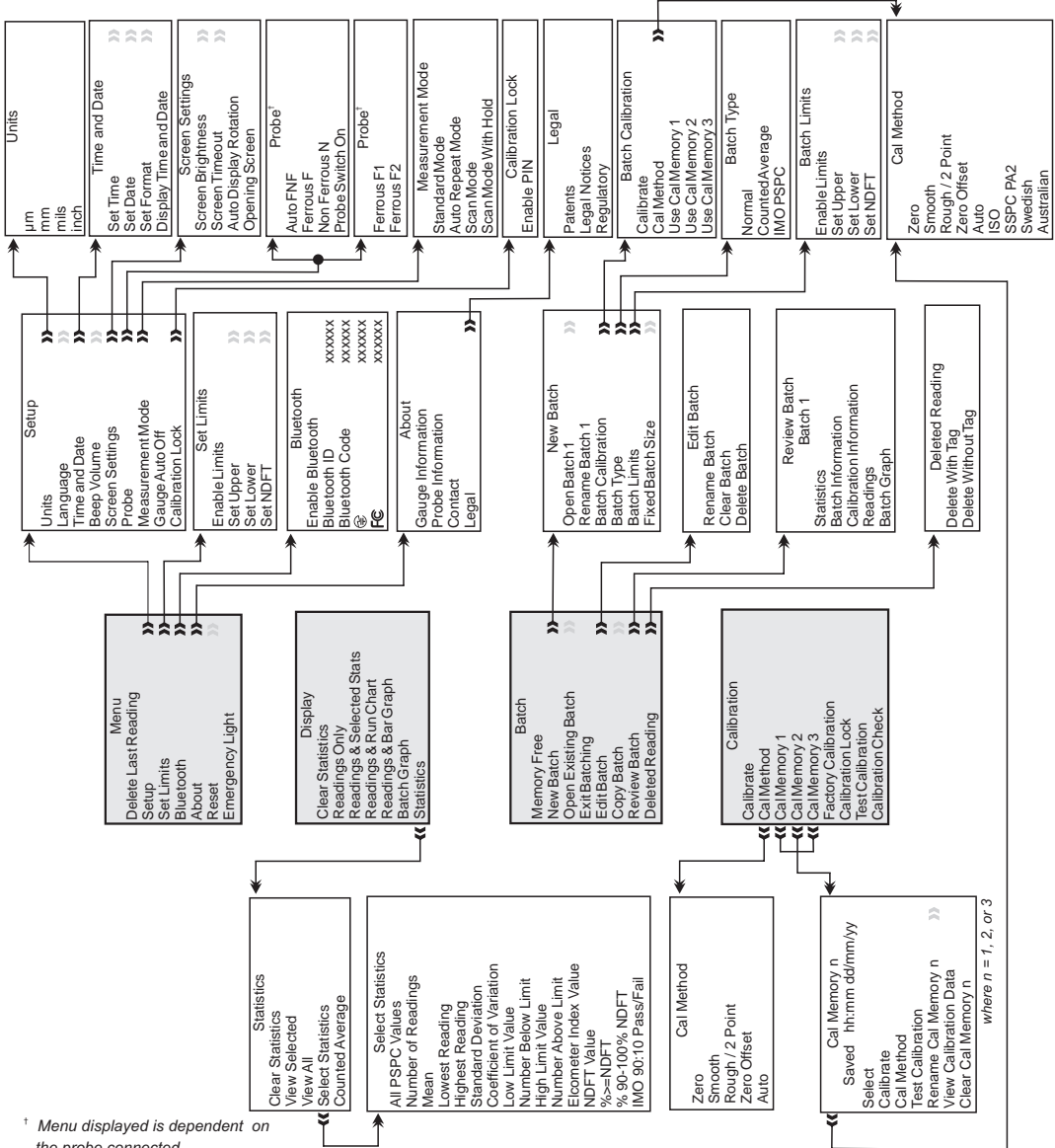

¹ Menu displayed is dependent on the probe connected

17 GAUGE MENU STRUCTURES CONTINUED (EBST)

Elcometer 456 Model S

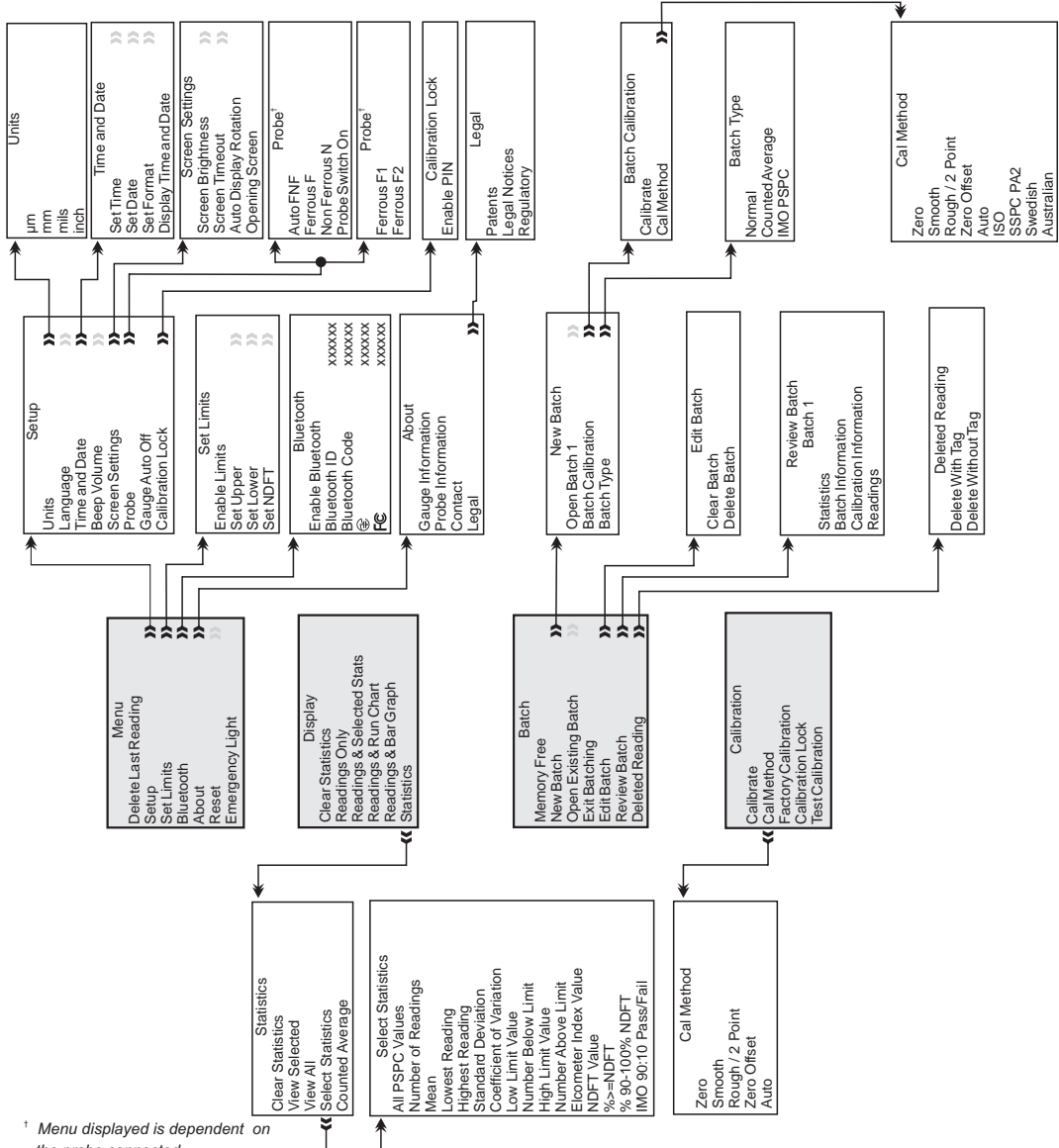

¹ Menu displayed is dependent on the probe connected

17 GAUGE MENU STRUCTURES CONTINUED (EBST)

Elcometer 456 Model B

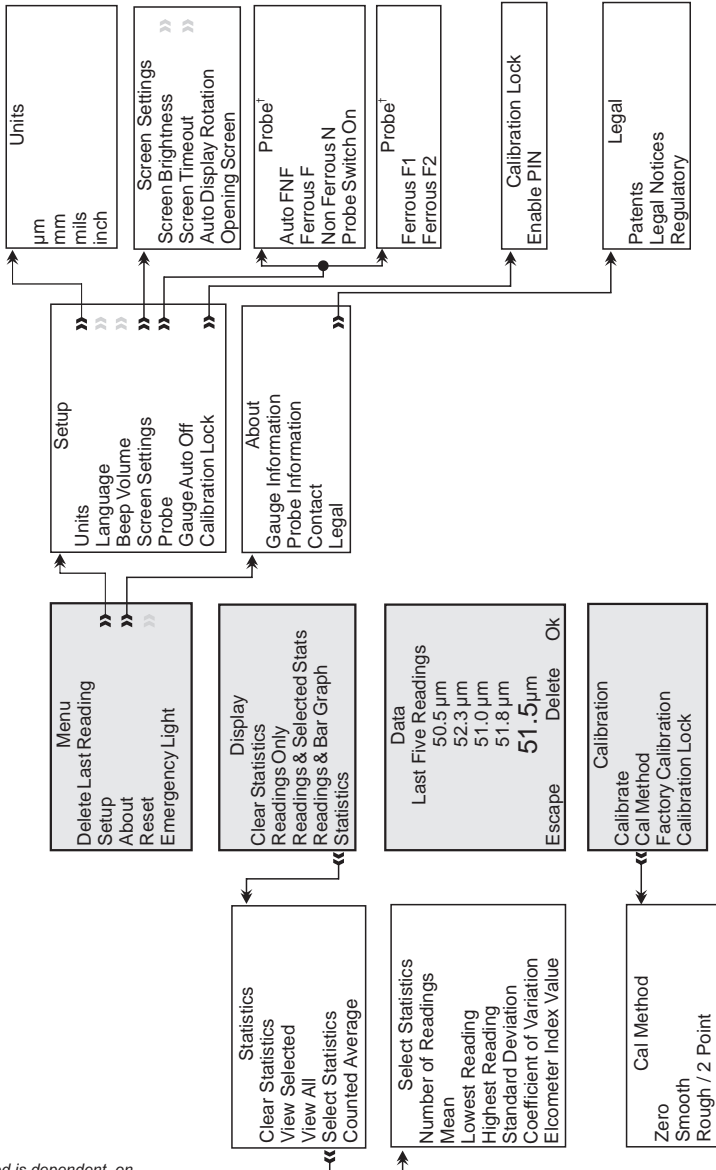

¹ Menu displayed is dependent on the probe connected

17 GAUGE MENU STRUCTURES CONTINUED (EBST)

Elcometer 456 Model E

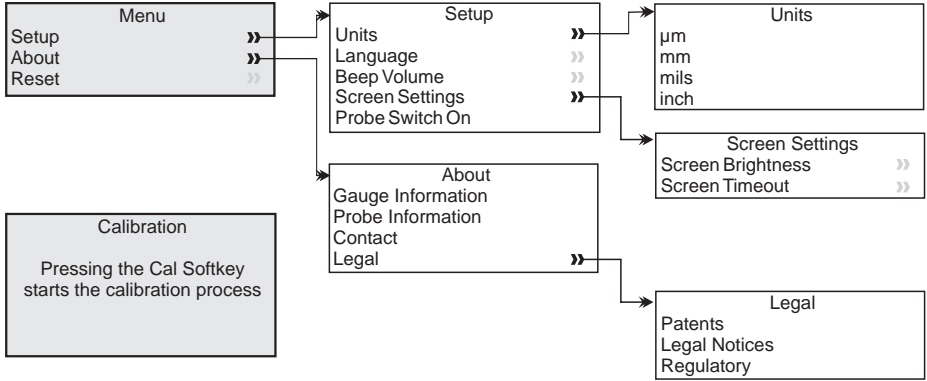

18 ABOUT IMO PSPC (ST)

The Elcometer 456 is capable of displaying PSPC readings according to the 90/10 rule as defined in the International Maritime Organisation (IMO) requirements.

To pass the 90/10 rule:

At least 90% of all thickness measurements shall be greater than or equal to the NDFT value and;

None of the remaining measurements shall be below 0.9 x NDFT.

To PASS 90/10
At least 90% of all readings must be in this zone...

90/10 FAILED if
Less than 90% of all readings are in this zone...

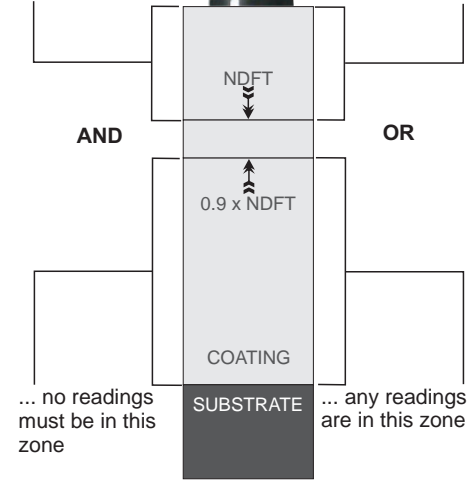

While you are taking readings with PSPC selected, your gauge will advise you whether the readings are passing or failing the rule:

- When the PSPC statistics are in the passing state, the reading value is white and the green LED flashes;
- When the PSPC statistics are in the percent fail state, the reading value is white and both the red and green LEDs flash;
- When the PSPC statistics are in the reading fail state, the reading value is red and the red LED flashes.

Note: The default value for NDFT is 320µm (12.6mils) - from PSPC for Ballast Water Tanks.

Note: The 90/10 rule is not compatible with the counted average data collection method (see Batching on page 26) and cannot be used when saving readings using this method.

19 GAUGE TECHNICAL SPECIFICATIONS (EBST)

Display Information	60mm (2.4") QVGA colour TFT display, 320 x 240 pixels
Battery Type	2 x AA dry cell batteries, rechargeable batteries can also be used
Battery Life	~24 hours of continuous use at 1 reading per second <i>Using default settings & lithium batteries supplied, alkaline or rechargeable batteries may differ</i>
Gauge Dimensions (h x w x d)	Integral: 141 x 73 x 37mm (5.55 x 2.87 x 1.46") Separate: 141 x 73 x 37mm (5.55 x 2.87 x 1.46")
Gauge Weight (including supplied batteries)	Integral: 156g (5.5oz) Separate: 161g (5.68oz)
Operating Temperature	-10 to 50°C (14 to 122°F)



20 PROBE TECHNICAL SPECIFICATIONS (EBST)

Available in a number of designs and scale ranges, all probes are supplied with an Elcometer test certificate and a set of calibration foils appropriate to the scale range.

Ferrous probes measure non magnetic coatings on ferro-magnetic substrates. Non-ferrous probes measure non conductive coatings on non-ferrous metal substrates. Dual FNF probes measure both ferrous and non-ferrous applications with automatic substrate detection.

Minimum Substrate Thickness	Ferrous:	0.3mm (12mils)
	Non-Ferrous:	0.1mm (4mils)
Maximum Operating Temperature (limited duty cycle)	Ferrous:	150°C (300°F)
	Non-Ferrous:	80°C (176°F)
	PINIP:	80°C (176°F)
	PINIP (High Temp):	250°C (480°F)
Storage Temperature	-10 to 60°C (14 to 140°F)	

SCALE 1

Range	0 - 1500µm (0 - 60mils)
Resolution	0.1µm: 0 - 100µm; 1µm: 100 - 1500µm (0.01mil: 0 - 5mils; 0.1mil: 5 - 60mils)
Accuracy	±1-3% or ±2.5µm (±1-3% or ±0.1mil)

Probe Design	Minimum Convex Surface Diameter	Minimum Concave Surface Radius	Minimum Headroom	Minimum Sample Diameter	
Straight	Ferrous	4mm (0.16")	25mm (0.98")	85mm (3.35")	4mm (0.16")
	Ferrous Sealed	4mm (0.16")	25mm (0.98")	85mm (3.35")	4mm (0.16")
	Non-Ferrous	10mm (0.39")	10mm (0.39")	85mm (3.35")	4mm (0.16")
	Dual FNF	F Mode: 4mm (0.16") N Mode: 26mm (1.02")	12.5mm (0.49")	88mm (3.46")	F Mode: 4mm (0.16") N Mode: 6mm (0.24")
Right Angle	Ferrous	4mm (0.16")	25mm (0.98")	28mm (1.10")	4mm (0.16")
	Non-Ferrous	10mm (0.39")	14mm (0.55")	28mm (1.10")	4mm (0.16")
	Dual FNF	F Mode: 4mm (0.16") N Mode: 26mm (1.02")	12.5mm (0.49")	38mm (1.50")	F Mode: 4mm (0.16") N Mode: 6mm (0.24")
Anodiser	Non-Ferrous	10mm (1.38")	14mm (0.55")	100mm (3.94")	4mm (0.16")
PINIP	Ferrous	4mm (0.16")	60mm (2.36")	170mm (6.69")	4mm (0.16")
	Non-Ferrous	10mm (0.39")	50mm (1.97")	180mm (7.09")	4mm (0.16")
	Dual FNF	F Mode: 4mm (0.16") N Mode: 26mm (1.02")	65mm (2.56")	180mm (7.09")	F Mode: 4mm (0.16") N Mode: 6mm (0.24")

* Whichever is the greater

SCALE 1 (continued)

Probe Design		Minimum Convex Surface Diameter	Minimum Concave Surface Radius	Minimum Headroom	Minimum Sample Diameter
Mini M5	Ferrous	3mm (0.12")	6.5mm (0.26")	Headroom: 16mm (0.63") Width: 7mm (0.28")	4mm (0.16")
	Ferrous Sealed	3mm (0.12")	6.5mm (0.26")	Headroom: 16mm (0.63") Width: 7mm (0.28")	4mm (0.16")
	Non-Ferrous	10mm (0.39")	8.5mm (0.33")	Headroom: 16mm (0.63") Width: 7mm (0.28")	4mm (0.16")

SCALE 2

Range	0 - 5mm (0 - 200mils)
Resolution	1µm: 0 - 1mm; 10µm: 1 - 5mm (0.1mil: 0 - 50mils; 1mil: 5 - 200mils)
Accuracy	±1-3% or ±20µm (±1-3% or ±1.0mil)

For higher resolution and accuracy on thin coatings Scale 2 ferrous probes can be switched to the Scale 1 mode measurement performance

Probe Design		Minimum Convex Surface Diameter	Minimum Concave Surface Radius	Minimum Headroom	Minimum Sample Diameter
Straight	Ferrous	4mm (0.16")	25mm (0.98")	89mm (3.50")	8mm (0.32")
	Non-Ferrous	100mm (3.97")	150mm (5.90")	88mm (3.46")	14mm (0.55")
Right Angle	Ferrous	4mm (0.16")	25mm (0.98")	32mm (1.26")	8mm (0.32")
Armoured	Ferrous	4mm (0.16")	25mm (0.98")	138mm (5.43")	8mm (0.32")
Telescopic	Ferrous	4mm (0.16")	25mm (0.98")	36mm (1.42")	8mm (0.32")
Soft Coating	Ferrous	Flat Surface	Flat Surface	89mm (3.50")	8mm (0.32")
Waterproof	Ferrous	4mm (0.16")	40mm (1.98")	138mm (5.43")	8mm (0.32")
PINIP	Ferrous	4mm (0.16")	60mm (2.36")	174mm (6.85")	8mm (0.32")
	Non-Ferrous	100mm (3.97")	150mm (5.90")	185mm (7.28")	14mm (0.55")

SCALE 3

Range	0 - 13mm (0 - 500mils)
Resolution	1µm: 0 - 2mm; 10µm: 2 - 13mm (0.1mil: 0 - 100mils; 1mil: 100 - 500mils)
Accuracy	±1-3% or ±50µm (±1-3% or ±2.0mils)

Probe Design		Minimum Convex Surface Diameter	Minimum Concave Surface Radius	Minimum Headroom	Minimum Sample Diameter
Straight	Ferrous	15mm (0.59")	40mm (1.57")	102mm (4.02")	14mm (0.55")
PINIP	Ferrous	15mm (0.59")	45mm (1.77")	184mm (7.24")	14mm (0.55")

* Whichever is the greater

SCALE 6

Range	Ferrous: 0 - 25mm (0 - 980mils) Non-Ferrous: 0 - 30mm (0 - 1200mils)				
Resolution	10µm: 0 - 2mm; 100µm: 2 - 30mm (1mil: 0 - 100mils; 10mil: 100 - 1200mils)				
Accuracy	±1-3% or ±100µm (±1-3% or ±4.0mils)				
Probe Design		Minimum Convex Surface Diameter	Minimum Concave Surface Radius	Minimum Headroom	Minimum Sample Diameter
Straight	Ferrous	35mm (1.40")	170mm (6.70")	150mm (5.90")	51 x 51mm ² (2 x 2 sq. inch)
	Non-Ferrous	Flat Surface	Flat Surface	160mm (6.30")	58mm (2.30")
Armoured	Ferrous	35mm (1.40")	170mm (6.70")	190mm (7.48")	51 x 51mm ² (2 x 2 sq. inch)
	Non-Ferrous	Flat Surface	Flat Surface	200mm (7.87")	58mm (2.30")

SCALE 0.5

Range	0 - 500µm (0 - 20mils)				
Resolution	0.1µm: 0 - 100µm; 10µm: 100 - 500µm (0.01mil: 0 - 5mils; 0.1mil: 5 - 20mils)				
Accuracy	±1-3% or ±2.5µm (±1-3% or ±0.1mil)				
Probe Design		Minimum Convex Surface Diameter	Minimum Concave Surface Radius	Minimum Headroom	Minimum Sample Diameter
Mini-M3 45mm (1.77")	Ferrous	1.9mm (0.07")	6.5mm (0.26")	6mm (0.24")	3mm (0.12")
	Non-Ferrous	6mm (0.24")	8.5mm (0.33")	6mm (0.24")	4mm (0.16")
Mini-M3-90° 45mm (1.77")	Ferrous	1.9mm (0.07")	6.5mm (0.26")	Headroom: 16mm (0.63") Width: 7mm (0.28")	3mm (0.12")
	Non-Ferrous	6mm (0.24")	8.5mm (0.33")	Headroom: 16mm (0.63") Width: 7mm (0.28")	4mm (0.16")
Mini-M3-45° 45mm (1.77")	Non-Ferrous Graphite	6mm (0.24")	8.5mm (0.33")	Headroom: 16mm (0.63") Width: 7mm (0.28")	4mm (0.16")
	Ferrous	1.9mm (0.07")	6.5mm (0.26")	Headroom: 18mm (0.71") Width: 7mm (0.28")	3mm (0.12")
Mini-M3-90° 150mm (5.90")	Ferrous	1.9mm (0.07")	6.5mm (0.26")	Headroom: 16mm (0.63") Width: 7mm (0.28")	3mm (0.12")
	Non-Ferrous	6mm (0.24")	8.5mm (0.33")	Headroom: 16mm (0.63") Width: 7mm (0.28")	4mm (0.16")
Mini-M3-90° 300mm (11.80")	Non-Ferrous Graphite	6mm (0.24")	8.5mm (0.33")	Headroom: 16mm (0.63") Width: 7mm (0.28")	4mm (0.16")
	Ferrous	1.9mm (0.07")	6.5mm (0.26")	Headroom: 16mm (0.63") Width: 7mm (0.28")	3mm (0.12")
Mini-M3-45° 300mm (11.80")	Ferrous	1.9mm (0.07")	6.5mm (0.26")	Headroom: 18mm (0.71") Width: 7mm (0.28")	3mm (0.12")
	Non-Ferrous	6mm (0.24")	8.5mm (0.33")	Headroom: 16mm (0.63") Width: 7mm (0.28")	4mm (0.16")
Mini-M3-90° 400mm (15.70")	Non-Ferrous Graphite	6mm (0.24")	8.5mm (0.33")	Headroom: 16mm (0.63") Width: 7mm (0.28")	4mm (0.16")
	Non-Ferrous Graphite	6mm (0.24")	8.5mm (0.33")	Headroom: 16mm (0.63") Width: 7mm (0.28")	4mm (0.16")

* Whichever is the greater

ULTRA/SCAN PROBES

The Elcometer 456 Ultra/Scan Probes have been specifically designed for use with the Scan and Auto Repeat Modes on Elcometer 456 Model T separate gauges - see Measurement Modes on page 25.

They are supplied with a highly durable ‘snap on’, user replaceable, probe cap - allowing users to take individual readings or rapidly scan large surface areas without damaging the probe or the coating.

They can also be used in Standard Mode - with or without the probe end cap fitted - when connected to any Elcometer 456 separate gauge.

The cap **must be** fitted when used in Scan or Auto Repeat Mode. Use in these modes without the cap will invalidate the probe warranty.

	Probe End Cap Fitted	Without Probe End Cap
Range	100 - 1000µm (4 - 40mils)	0 - 1500µm (0 - 60mils)
Resolution	1µm (0.1mil)	1µm (0.1mil)
Accuracy	±3% or ±2.5µm (±0.1mil)‡	±1-3% or ±2.5µm (±0.1mil)‡

Probe Design	Probe End Cap Fitted		Without Probe End Cap	
	Minimum Headroom	Minimum Sample Diameter	Minimum Headroom	Minimum Sample Diameter
Ultra/Scan Ferrous	89mm (3.50")	15mm (0.59")	85mm (3.35")	4mm (0.16")
Ultra/Scan Dual FNF	89mm (3.50")	15mm (0.59")	88mm (3.46")	F Mode: 4mm (0.16") N Mode: 6mm (0.24")

Ultra/Scan probe end caps wear over time and the gauge will inform the user during the calibration procedure if the cap needs replacing. When tested using smooth surfaces, probe end caps have been scanned in excess of 50km (30 miles).

Replacement caps are available to purchase from Elcometer or your local supplier.

Description	Part Number
Replacement Ultra/Scan Probe End Caps (3 per pack)	T456C23956

‡ Whichever is the greater. When calibrated using a sample of the uncoated base.

21 GAUGE & PROBE ACCESSORIES (EBST)

Probe Placement Jig

An ideal accessory for measuring coatings not only on small or complex components but also when the highest levels of repeatability and accuracy are required. Each Probe Placement Jig is supplied with a probe housing to suit Scale 1 or Scale 2 Straight Probes and a component holder. Additional accessories are also available.



Description	Part Number		Part Number
Probe Placement Jig	T95012880	Dual FNF Probe Housing Adaptor	T95015961
Component Hand Vice	T95013028	Mini Probe Housing Adaptor	T95016896
Cable Release Assembly	T95012888		

Jumbo and V-Probe Adaptors

Jumbo and V-Probe Adaptors, when attached to any Elcometer 456 Scale 1 or Scale 2 straight probe, improve measurement accuracy and repeatability on flat and curved surfaces.



Description / Part Number	F and N Probes	Dual FNF Probes
Jumbo Adaptor	T9997766-	T99913225
V-Probe Adaptor	T9997381-	T99913133

Gauge Accessories

Description / Part Number	Separate Gauges	Integral Gauges
Protective Case	T99923369	T45621820
Plastic Transit Case	T45623465	T45623466
Benchtop Inspection Stand	T45622371	-
Self Adhesive Screen Protectors (x10)	T99922341	T99922341
USB Bluetooth Adaptor - for PC's without Bluetooth	T99920130	T99920130
USB Cable	T99921325	T99921325

en Calibration Accessories

Formal quality systems, such as those described in ISO 9000, require that gauges be properly controlled, logged and in calibration. Increasingly, users are specifying that the readings taken by gauges are traceable to National Standards.

Three types of coating thickness standards are available from Elcometer - Calibration Foils; Coated Standards and Zero Test Plates.



Foil Sets

Scale Range	Foil Values		Part Number	
	(μm)	(mils)	Un-Certified	Certified
Scale 1: 0-1500 μm (0-60mils)	25, 50, 125, 250, 500, 1000	1.0, 2.0, 5.0, 10, 20, 40	T99022255-1	T99022255-1C
Scale 2: 0-5mm (0-200mils)	25, 50, 125, 250, 500, 1000, 2000, 3000	1.0, 2.0, 5.0, 10, 20, 40, 80, 120	T99022255-2	T99022255-2C
Scale 3: 0-13mm (0-500mils)	250, 500, 1000, 2000, 4000, 8000	10, 20, 40, 80, 160, 315	T99022255-3	T99022255-3C
Scale 6: 0-30mm (0-1200mils)	1000, 2000, 5000, 9500, 15mm, 25mm	40, 80, 200, 375, 590, 980	T99022255-6	T99022255-6C
Scale M3: 0-500 μm (0-20mils)	12.5, 25, 50, 125, 250, 500	0.5, 1.0, 2.0, 5.0, 10, 20	T99022255-7	T99022255-7C
Scale 2B: 0-5mm (0-200mils)	25, 50, 125, 250, 500, 1000, 2000, 2000	1.0, 2.0, 5.0, 10, 20, 40, 80, 80	T99022255-8	T99022255-8C

The Scale 2B foil sets are designed for the Elcometer 456 soft coating probe and have a larger foil surface area. Individual foils are also available - contact Elcometer or visit our website for more information.

Coated Thickness Standards

Values (μm)	(mils)	Part Number	
		Ferrous	Non-Ferrous
0, 40, 75, 125, 175	0, 1.6, 3.0, 5.0, 7.0	T995111262	T995111271
0, 50, 80, 125, 200	0, 2.0, 3.0, 5.0, 8.0	T995111263	-
0, 50, 150, 250, 500	0, 2.0, 6.0, 10, 20	T995111261	-

Zero Test Plates

Description	Dimensions	Part Number	
		Ferrous	Non-Ferrous
Zero Test Plate $\pm 1\%$	50.8 x 25.4mm (2.0 x 1.0")	T9994910-	T9994911-
Zero Test Plate $\pm 2\%$	76.2 x 50.8mm (3.0 x 2.0")	T9999529-	T9999530-
Zero Test Plate; large $\pm 2\%$	76.2 x 101.6mm (3.0 x 4.0")	T9994054-	T9994055-

22 ADDITIONAL REFERENCE INFORMATION

Standards

The Elcometer 456 can be used in accordance with the following National and International Standards:

AS 2331.1.4	ASTM E 376	DIN 50981	ISO 19840	ISO 2808-12
AS 3894.3-B	ASTM G 12	DIN 50984	ISO 2063	NF T30-124
AS/NZS 1580.108.1	BS 3900-C5-6B	ECCA T1	ISO 2360	SS 184159
ASTM B 499	BS 3900-C5-6A	EN 13523-1	ISO 2808-6A	SSPC PA 2
ASTM D 1186-B	BS 5411-11	IMO MSC.215(82)	ISO 2808-6B	US Navy NSI 009-32
ASTM D 1400	BS 5411-3	IMO MSC.244 (83)	ISO 2808-7C	US Navy PPI 63101-000
ASTM D 7091	BS 5599	ISO 1461	ISO 2808-7D	

Standards in grey have been superceded but are still recognised in some industries.

Certification

Every Elcometer 456 gauge and separate probe is supplied with a Test Certificate free of charge. For separate gauges, the test measurements are generated using factory reference probes. Each probe test certificate is generated using factory reference gauges.

Comprehensive Calibration Certificates, traceable to National Standards (UKAS and NIST) are also available and should be requested at the point of order. Please speak to your Elcometer representative for further information.

Warranty and Maintenance

The Elcometer 456 does not contain any user serviceable components. In the unlikely event of a fault, the gauge should be returned to your local Elcometer supplier or directly to Elcometer. The warranty will be invalidated if the gauge has been opened.

The Elcometer 456 gauge is supplied with a 1 year warranty against manufacturing defects. To extend this warranty to 2 years, register your gauge via the www.elcometer.com website.

Probes are consumable items and have a 1 year warranty from the date of purchase against manufacturing defects only. The probe tip will wear and its life will depend on the number of readings taken and how abrasive the coating is. Probe life can be prolonged by careful positioning of the probe on the surface.

This gauge incorporates a Liquid Crystal Display (LCD). If the display reaches a temperature above 70°C (158°F) it may be damaged. This can happen if the gauge is left in a car, parked in strong sunlight.

Always store the gauge in its carrying pouch when not in use.

Remove the batteries from the gauge and store them separately if the gauge is to remain unused for a long period of time. This will prevent damage to the gauge in the event of malfunction of the batteries.

23 INDEX

Numerics		Specification	75
2 Point Calibration Method	19, 60, 67	Beep Volume	6, 68
2 Year Gauge Warranty	12, 82	Bluetooth	
90/10 Rule	15, 66, 74	Data Output	13
A		Downloading data	35, 44
Accessories	80	PIN Code	43
Analogue Bar Graph	16	USB Adaptor	75
AS 2331.1.4	82	BS 3900-C5-6B	82
AS 3894.3-B	82	BS 3900-C5-6A	82
AS/NZS 1580.108.1	82	BS 5411-11	82
ASTM B 499	82	BS 5411-3	82
ASTM D 1186-B	82	BS 5599	82
ASTM D 1400	82	C	
ASTM D 7091	82	Calibration	8, 60
ASTM E 376	82	Accessories	81
ASTM G 12	82	Adjustment / Procedure; Model E	61
Australian Calibration Method	21, 67	Adjustment / Procedure; Model B, S & T	61
Auto Calibration Method	20, 67	Certificates	82
Auto Repeat Mode	25, 79	Lock	22, 63, 67
B		Memories	21, 27
Batching	26	Methods	18, 60
Batch calibration memories	27	Testing	62
Clearing an existing batch	29	Validating	62
Copying an existing batch	29	Warning	22, 65
Creating a new batch	26	Certification	82
Delete an existing batch	32	Character Size	11
Naming batches	27	Coated Thickness Standards	81
Opening an existing batch	29	Coefficient of Variation	14, 66
Readings graph	31	Counted Average	14, 32
Reviewing an existing batch	30	D	
Batch Mode	26	Data Collection Methods	25
Batch Naming	27	Date and Time	17
Batch Size	33	Delete Readings	26, 66
Batch Types	32, 68	Dimensions	75
Counted Average	32, 68	DIN 50981	82
IMO PSPC	33, 68	DIN 50984	82
Normal	32, 68	Display	9
Battery / Batteries		Brightness	12
Condition	5, 68	Reading Size	11
Fitting	5	Rotating	13
Life of	68, 75	Specification	75
Powered	12		
Precautions	82		

Downloading Data		ISO 1461	82
via Bluetooth	13, 35, 44	ISO 19840	82
via ElcoMaster 2.0	13, 35, 44	ISO 2063	82
via USB	13, 35, 44	ISO 2360	82
E		ISO 2808-6A	82
ECCA T1	82	ISO 2808-6B	82
ElcoMaster 2.0	35	ISO 2808-7C	82
Elcometer Index Value (EIV)	15, 66	ISO 2808-7D	82
Emergency Light Mode	12	ISO 2808-12	82
EN 13523-1	82	ISO Calibration Method	21, 67
Error Codes	69	L	
F		Language Selection	6, 12
Factory Calibration	20, 61	Limits	15, 23, 66, 67
Firmware Updates	13, 65	Live Gauge Readings	52
Fixed Batch Size	33	Lowest Reading	14, 66
Foil Sets	81	M	
G		Maintenance	82
Gauge		Mean	14
About	3	Measurement Modes	25
Accessories	80	Memory	23
Error Codes	69	Menu Structure	70
Features	12	N	
Firmware Updates	13, 65	NF T30-124	82
Icons	66	P	
Maintenance	82	Probe	
Memory	23	Connection	5
Menu Structures	70	Scale Range	76
Overview	4	Technical Specification	76
Technical Specifications	75	R	
Warranty	12, 82	Reading, taking a	7
Welcome Screen	24, 64	Reading Display	11
H		Reading Rate	12
High Limit	15, 66, 67	Rotating Display	12
Highest Reading	14, 66	Rough / 2 Point Calibration Method	19, 60, 67
I		Run Chart	17
Icons	66	S	
Immediate (Standard) Mode	25	Scale Ranges	76
IMO MSC.215(82)	82	Scan Mode	25
IMO MSC.244 (83)	82	Setting Limits	23
IMO PSPC		Shims	81
About	15, 74	Smooth Calibration Method	19, 60, 67
Batch Type	33, 67	Software, ElcoMaster 2.0	35
		SSPC PA2	82

Standard (Immediate) Mode	25
SSPC PA2 Calibration Method	21, 67
Standards, Coated Thickness	81
Standards	81
Statistics	14
Swedish Calibration Method	21, 63
Switching On / Off	6
T	
Technical Specifications	75
Test Certificates	82
Time and Date	17
Two Point Calibration Method	19, 60, 67
Two Year Gauge Warranty	12, 82
U	
Units, Selecting	6
US Navy NSI 009-32	82
US Navy PPI 63101-000	82
W	
Welcome Screen	24, 64
Weight	75
Wrist Harness, Fitting	6
Z	
Zero Calibration Method	19, 60, 67
Zero Offset Calibration Method	19, 60, 67
Zero Test Plates	81

elcometer®

www.elcometer.com

ENGLAND

Elcometer Limited
Edge Lane
Manchester M43 6BU
Tel: +44 (0)161 371 6000
Fax: +44 (0)161 371 6010
e-mail: sales@elcometer.com
www.elcometer.com

USA

Elcometer Inc
1893 Rochester Industrial Drive
Rochester Hills Michigan 48309
Tel: +1 248 650 0500
Toll Free: 800 521 0635
Fax: +1 248 650 0501
e-mail: inc@elcometer.com
www.elcometer.com

ASIA & THE FAR EAST

Elcometer (Asia) Pte Ltd
896 Dunearn Rd
Sime Darby Centre #03-09
Singapore 589472,
Tel: +65 6462 2822
Fax: +65 6462 2860
e-mail: asia@elcometer.com
www.elcometer.com

JAPAN

Elcometer KK
7F Toranomon MT40 Bldg. 5-13-1
Toranomon, Minato-ku
Tokyo 105-0001
Tel: +81 (0)3-4530-9714
Fax: +81 (0)3-4530-9713
email: jp_info@elcometer.com
www.elcometer.co.jp

BELGIUM

Elcometer SA
Rue Vallée 13
B-4681 Hermalle /s Argenteau
Tel: +32 (0)4 379 96 10
Fax: +32 (0)4 374 06 03
e-mail: be_info@elcometer.com
www.elcometer.be

FRANCE

Elcometer Sarl
97 Route de Chécy
45430 BOU
Tel: +33 (0)2 38 86 33 44
Fax: +33 (0)2 38 91 37 66
e-mail: fr_info@elcometer.com
www.elcometer.fr

GERMANY

Elcometer Instruments GmbH
Ulmer Strasse 68
D-73431 Aalen
Tel: +49(0)7361 52806 0
Fax: +49(0)7361 52806 77
e-mail: de_info@elcometer.de
www.elcometer.de

THE NETHERLANDS

Elcometer NL
Newtonlaan 115
3584 BH Utrecht
Tel: +31 (0)30 210.7005
Fax: +31 (0)30 210.6666
email: nl_info@elcometer.com
www.elcometer.com