

**COOL-AIR TUBE
MODEL CAT
O. M. 08956**

DATE OF ISSUE: 01-30-84
REVISION: H 02-15

! WARNING

Do not use this equipment until you have READ this MANUAL and YOU UNDERSTAND its contents. *

These WARNINGS are included for the health and safety of the operator and those in the immediate vicinity.

***If you are using a Clemco Distributor Maintenance and Parts Guide, refer to the orange warnings insert preceding the Index before continuing with the enclosed instructions.**

Electronic files include a Preface containing important information.

© 2015 CLEMCO INDUSTRIES CORP.
One Cable Car Dr.
Washington, MO 63090
Phone (636) 239-4300
FAX (800) 726-7559
Email: info@clemcoindustries.com
www.clemcoindustries.com



WARNING

- Employers are responsible for identifying all job site hazards, educating and training all persons who will operate and maintain these products, and ensuring that all blast operators and their assistants understand the warnings and information contained in these instructions relating to safe and proper operation and maintenance of this equipment.
- Serious injury or death can result from failure to comply with all Occupational Safety and Health Administration (OSHA) regulations and all manufacturer's instructions.
- This equipment is not intended for use in any area considered hazardous per National Electric Code NFPA 70 2011, Article 500.
- Read this document and follow all instructions before using this equipment.

OSHA regulations relating to abrasive blasting are contained in the Code of Federal Regulations, Title 29 (29 CFR 1910 General Industry; 1915 Maritime; 1926 Construction). The most pertinent include: 1910.94 Ventilation, 1910.95 Occupational Noise Exposure, 1910.132 Personal Protective Equipment, 1910.133 Eye and Face Protection, 1910.134 Respiratory Protection, 1910.135 Head Protection, 1910.244 (b) Remote Controls. Consult www.osha.gov for complete information.

NOTICE TO PURCHASERS AND USERS OF OUR PRODUCTS AND THIS INFORMATIONAL MATERIAL

Clemco proudly provides products for the abrasive blast industry and is confident that industry professionals will use their knowledge and expertise for the safe and efficient use of these products.

The products described in this material, and the information relating to these products, are intended for knowledgeable, experienced users.

No representation is intended or made as to: the suitability of the products described here for any purpose or application, or to the efficiency, production rate, or useful life of these products. All estimates regarding production rates or finishes are the responsibility of the user and must be derived solely from the user's experience and expertise, not from information contained in this material.

It is possible that the products described in this material may be combined with other products by the user for purposes determined solely by the user. No representations are intended or made as to the suitability of or engineering balance of or compliance with regulations or standard practice of any such combination of products or components the user may employ.

Abrasive blast equipment is only one component of an abrasive blasting job. Other products, such as air compressors, air filters and receivers, abrasives, scaffolding, hydraulic work platforms or booms, equipment for lighting, painting, ventilating, dehumidifying, parts handling, or specialized respirators or other equipment, even if offered by Clemco, may have been manufactured or supplied by others. The information Clemco provides is intended to support the products Clemco manufactures. Users must contact each manufacturer and supplier of products used in the blast job for warnings, information, training, and instruction relating to the proper and safe use of their equipment.

GENERAL INSTRUCTIONS

This material describes some, but not all, of the major requirements for safe and productive use of blast machines, remote controls, respirator systems, and related accessories. All equipment and accessories must be installed, tested, operated and maintained only by trained, knowledgeable, experienced users.

The blast operator and all workers in the vicinity must be properly protected from all job site hazards including those hazards generated by blasting.

Work environments involving abrasive blasting present numerous hazards. Hazards relate to the blast process from many sources that include, but are not limited to, dust generated by blasting or from material present on the surface being blasted. The hazards from toxic materials may include, but are not limited to, silica, cyanide, arsenic, or other toxins in the abrasives or in the coatings, such as lead or heavy metals. Other hazards from toxins include, but are not limited to, fumes from coating application, carbon monoxide from engine exhaust, contaminated water, chemicals or asbestos. In addition, physical hazards that may be present include, but are not limited to, uneven work surfaces, poor visibility, excessive noise, and electricity. Employers must identify all job site hazards and protect workers in accordance with OSHA regulations.

Never modify Clemco equipment or components or substitute parts from other manufacturers for any Clemco components or parts. Any unauthorized modification or substitution of supplied-air respirator parts violates OSHA regulations and voids the NIOSH approval.

IMPORTANT

Contact Clemco for free booklets:

Blast Off 2 – Guide to Safe, Productive, and Efficient Abrasive Blasting, and Abrasive Blasting Safety Practices – Guide to Safe Abrasive Blasting.

Clemco Industries Corp. One Cable Car Drive Washington MO 63090

Tel: 636 239-4300 — Fax: 800 726-7559

Email: info@clemcoindustries.com

Website: www.clemcoindustries.com

OPERATIONAL INSTRUCTIONS

OPERATOR SAFETY EQUIPMENT

WARNING

- OSHA regulation 1910.134 requires appropriate respiratory protection for blast operators and workers in the vicinity of blasting. These workers must wear properly-fitted, properly-maintained, NIOSH-approved, respiratory protection that is suitable for the job site hazards. Blast respirators are to be worn only in atmospheres not immediately dangerous to life or health from which wearers can escape without use of the respirator.
- The employer must develop and implement a written respiratory protection program with required worksite- specific procedures and elements for required respirator use. The employer must provide effective training to employees who are required to use respirators. The training must be comprehensive, understandable, and recur annually, and more often if necessary.
- NEVER use abrasives containing more than one percent crystalline silica. Fatal diseases, such as silicosis, asbestosis, lead or other poisoning, can result from inhalation of toxic dusts, which include, but are not limited to, crystalline silica, asbestos, and lead paint. Refer to NIOSH Alert 92-102; and OSHA CPL 03-00-007: “National Emphasis Program – Crystalline Silica”, in which OSHA describes policies and procedures for implementing a national emphasis program to identify and reduce or eliminate health hazards from exposure to crystalline silica. Numerous topics associated with the hazards of crystalline silica in silica blasting sand can be found on [http:// osha.gov/](http://osha.gov/). Clemco urges users of silica blasting sand to visit this website, and read and heed the information it contains.
- Always make sure the breathing air supply (respirator hose) is not connected to plant lines that supply gases that include, but are not limited to, oxygen, nitrogen, acetylene, or other non-breathable gas. Never modify or change respirator air line connections without first testing the content of the line for safe breathing air. Failure to test the line may result in death to the respirator user.

- Breathing air quality must be at least Grade D, as defined by the Compressed Gas Association specification G-7.1, per OSHA Regulation 29 CFR 1910.134. When compressed air is the breathing air source, a Clemco CPF (suitable sorbent bed filter) should be used. Respirator hose connecting the respirator to the filter must be NIOSH approved. Non- approved hose can cause illness from chemicals employed to manufacture the hose.

- All workers must always wear NIOSH-approved respirators when any dust is present. Exposure to dust can occur when handling or loading abrasive, blasting, cleaning up abrasive, or working in the vicinity of blasting. Before removing the respirator, test the air with a monitoring device to ensure it is safe to breathe.

- Clemco respirators DO NOT remove or protect against carbon monoxide or any other toxic gas. Monitoring devices must be used in conjunction with the respirator to ensure safe breathing air. Always locate compressors and ambient air pumps where contaminated air will not enter the air intake.

- Always use Clemco lenses with Clemco respirators; installing non-approved lenses voids the NIOSH approval. Respirator lenses are designed to protect the wearer from rebounding abrasive; they do not protect against flying objects, heavy high-speed materials, glare, liquids, or radiation.

INDUSTRY ORGANIZATIONS

For additional information, consult:

Occupational Safety and Health Administration (OSHA) - www.osha.gov

Compressed Gas Association (CGA) - www.cganet.com

The Society for Protective Coatings (SSPC) - www.sspc.org

National Association of Corrosion Engineers (NACE) - www.nace.org

American Society for Testing and Materials (ASTM) - www.astm.org

National Institute of Occupational Safety and Health (NIOSH) - www.niosh.gov

American National Standards Institute (ANSI) - www.ansi.org

PREFACE

BLAST MACHINES AND REMOTE CONTROLS

⚠ WARNING

OSHA regulation 1910.169 describes the necessity of pressure relief valves on compressed air equipment. Do not operate blast machines with air compressors that are not equipped with properly functioning pressure relief valves.

OSHA regulation 1910.244(b) requires the use of remote controls on blast machines.

Serious injury or death can result from many sources, among them:

- Involuntary activation of the remote controls. Never modify or substitute remote control parts; parts are not compatible among different manufacturers. Welding hose is not suitable for remote control hose. Its ID and material composition make it unsafe for remote control use.
- Exceeding the maximum working pressure. Clemco blast machines are built to ASME-code and carry a 'U' or 'UM' stamp, and National Board/serial number. Every machine is marked with its maximum working pressure. Never exceed the maximum working pressure limits of the blast machine.
- Uncontrolled blast stream. High-velocity abrasive particles will inflict serious injury. Always point the blast nozzle in the direction of the blast surface only. Keep unprotected workers out of the blast area.
- Welding on the blast machine. Never weld on the blast machine; welding voids the National Board approval and may affect the dimensional integrity of the vessel.
- Moving the blast machine. Never manually move a blast machine containing abrasive, any machine containing abrasive must be moved with appropriate mechanical lifting equipment.

HOSES, COUPLINGS, AND NOZZLE HOLDERS

- The inside diameter (ID) of air hoses, fittings, and connections should be at least four times larger than the nozzle orifice size. Blast hose ID should be three to four times the size of the nozzle orifice. Example: a #6 nozzle (3/8" diameter orifice) calls for 1-1/2" ID blast hose and 1-1/2" ID or larger compressor hose. All hose runs should be kept as short as possible and run in as straight a line as possible to reduce pressure loss.
- To install, squarely cut the end of the hose so that it fits snugly against the coupling or hose end shoulder. Always use the screws recommended by the manufacturer ensuring that they do not penetrate the inner wall. Make sure the couplings tightly fit the hose. Install cotter pins at every connection or use couplings with built-in lock-springs to prevent disengagement. Install safety cables at all connections to prevent whipping if hoses disengage or blow out.

MAINTENANCE AND REPAIR

- Completely read and follow all service instructions and recommended maintenance intervals. Always shut off compressor and depressurize blast machine before performing any maintenance. At every service interval, clean all filters, screens, and alarm systems. If spring-loaded abrasive valves are used, always cage spring before disassembly.

WARRANTY

The following is in lieu of all warranties, express, implied or statutory, and in no event shall seller or its agents, successors, nominees or assignees, or either, be liable for special or consequential damage arising out of a breach of warranty. This warranty does not apply to any damage or defect resulting from negligent or improper assembly or use of any item by the buyer or its agent or from alteration or attempted repair by any person other than an authorized agent of seller. All used, repaired, modified, or altered items are purchased "as is" and with all faults. In no event shall seller be liable for consequential or incidental damages. The sole and exclusive remedy of buyer for breach of warranty by seller shall be repair or replacement of defective parts or, at seller's option, refund of purchase price, as set forth below

1. Seller makes no warranty with respect to products used other than in accordance hereunder.
 2. On products seller manufactures, seller warrants that all products are to be free from defects in workmanship and materials for a period of one year from date of shipment to buyer, but no warranty is made that the products are fit for a particular purpose.
 3. On products which seller buys and resells pursuant to this order, seller warrants that the products shall carry the then standard warranties of the manufacturers thereof, a copy of which shall be made available to the customer upon request.
 4. The use of any sample or model in connection with this order is for illustrative purposes only and is not to be construed as a warranty that the product will conform to the sample or model.
 5. Seller makes no warranty that the products are delivered free of the rightful claim of any third party by way of patent infringement or the like.
 6. This warranty is conditioned upon seller's receipt within ten (10) days after buyer's discovery of a defect, of a written notice stating in what specific material respects the product failed to meet this warranty. If such notice is timely given, seller will, at its option, either modify the product or part to correct the defect, replace the product or part with complying products or parts, or refund the amount paid for the defective product, any one of which will constitute the sole liability of the seller and a full settlement of all claims. No allowance will be made for alterations or repairs made by other than those authorized by seller without prior written consent of seller. Buyer shall afford seller prompt and reasonable opportunity to inspect the products for which any claim is made as above stated.
- Except as expressly set forth above, all warranties, express, implied or statutory, including implied warranty of merchantability, are hereby disclaimed.

PREFACE

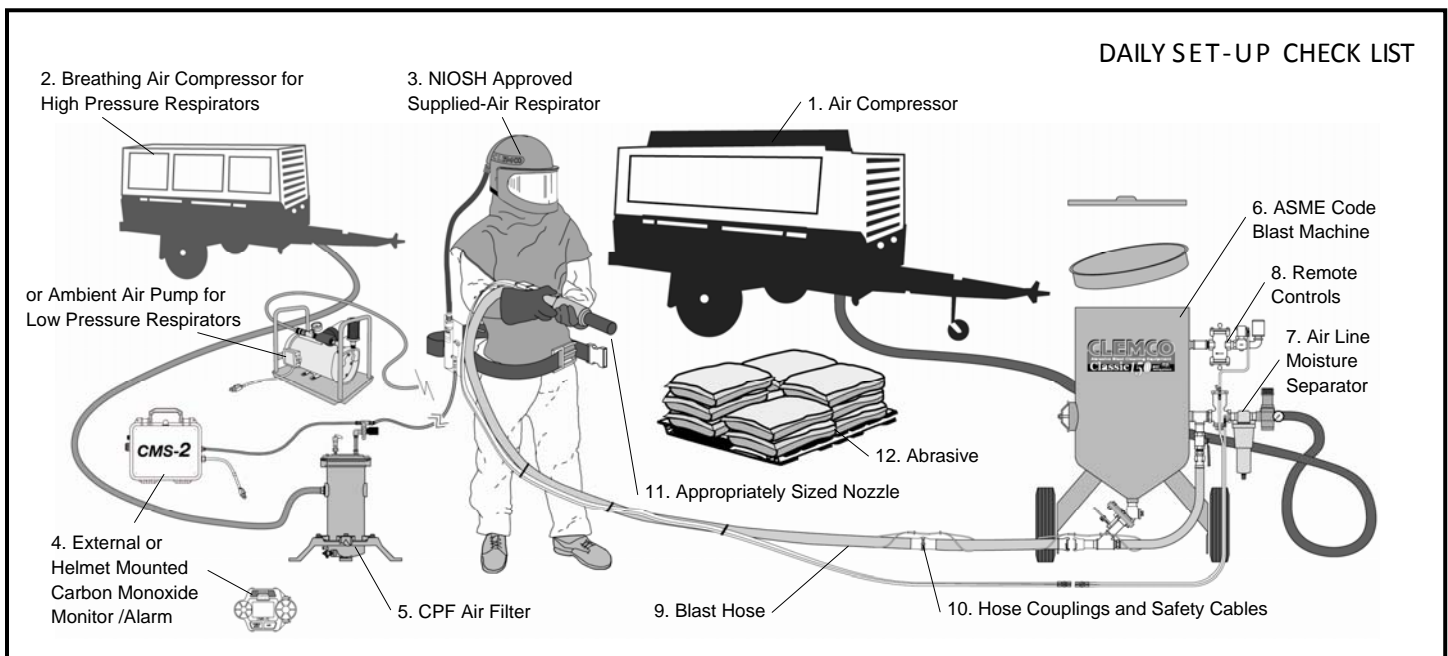

DAILY SET-UP CHECK LIST

Make sure all blast operators are properly trained and suitably attired with a blast suit, safety boots, leather gloves, respiratory and hearing protection. Every day before start up, check all equipment components, including piping, fittings, and hoses, and valves, for leaks, tightness, and wear. Repair or replace as needed. Use the following checklist.

- 1. PROPERLY-MAINTAINED AIR COMPRESSOR** sized to provide sufficient volume (cfm) at given pressure for nozzle and other tools. ADD 50% volume (cfm) reserve to allow for nozzle wear. Use large compressor outlet and air hose (at least 4 times the nozzle orifice diameter). For oil-lubricated compressors, the employer shall use a high- temperature or carbon monoxide alarm, or both, to monitor carbon monoxide levels. If only high-temperature alarms are used, the air supply shall be monitored at intervals sufficient to prevent carbon monoxide in the breathing air from exceeding 10 ppm. Follow the manufacturer's checklist and maintenance instructions.
- 2. BREATHING-AIR COMPRESSOR** (or oil-less ambient air pump) capable of providing Grade D quality air, located in a dust free area. Read # 1 above.
- 3. CLEAN, PROPERLY-MAINTAINED NIOSH-APPROVED SUPPLIED-AIR RESPIRATOR** worn by blast operators, and other workers exposed to blast dust. Make sure all respirator components are in place — all lenses, inner collar, and cape. Thoroughly inspect all components for wear. The NIOSH approval (approval number is listed in the owner's manual) is for a complete assembly from point of attachment on the CPF (sorbet bed) filter to the complete respirator. Substitution of any part voids the NIOSH approval.
- 4. CARBON MONOXIDE MONITOR/ALARM** installed at the CPF filter or inside the supplied-air respirator for monitoring for the presence of deadly CO gas and warning the operator(s) when the CO level reaches an unacceptable level. When an ambient air pump is used for breathing air, a CO monitor provides a measure of safety. Read # 1 above.
- 5. BREATHING-AIR FILTER (OSHA-REQUIRED sorbet bed filter)** for removal of moisture and particulate matter in the compressed air breathing-air supply. Monitor the condition of the cartridge and replace when odor is detected or at 3 month intervals, whichever comes sooner. The breathing air filter does NOT detect or remove carbon monoxide (CO). Always install a CO monitor/alarm.
- 6. BLAST MACHINE** (bearing U or UM stamp, National Board Number, and Maximum Working Pressure) sized to hold a 30-minute abrasive supply. Examine pop-up valve for alignment. Check piping, fittings, screens, valves for tightness, leaks, and wear. Always ground the machine to eliminate hazard of static shock. Install a blast machine screen to keep out foreign objects. Use a blast machine cover if left outdoors overnight. Never exceed the maximum working pressure of the vessel.
- 7. AIR LINE FILTER** (moisture separator) installed as close as possible to the blast machine inlet and sized to match the size of the inlet piping or larger air supply line. Clean filter and drain often. Damp abrasive causes operational problems.
- 8. REMOTE CONTROLS** are required by OSHA and must be in perfect operating condition. Test and check all components to ensure all parts are present and fully functional. Use genuine replacement parts. NEVER mix parts from different manufacturers. Never use welding hose for remote control hose.
- 9. BLAST HOSE** should have an inside diameter sized to suit the blast nozzle. The ID should be three to four times the size of the nozzle orifice diameter. Blast hose should be arranged in as straight a line as possible from the blast machine to the work area, avoiding sharp bends.
- 10. COUPLINGS AND NOZZLE HOLDERS** should fit snugly on the hose and be installed with manufacturer recommended screws. Coupling lugs must snap firmly into locking position. Gasket must always be used to form a positive seal, and cotter pins must be installed. Replace gasket when wear, softness or distortion is detected. Check nozzle holder for thread wear; replace at any sign of wear. Install safety cables at all connections.
- 11. NOZZLE** orifice size should be checked and nozzle replaced when worn 1/16" from original size. (No. 5 nozzle has 5/16" orifice diameter; replace when it measures 3/8"). Threads should be inspected daily for wear and nozzle should be replaced when wear is detected. Always use a nozzle washer.
- 12. ABRASIVE** must be a material specifically manufactured for blasting. It should be properly sized for the job. Check material safety data sheet for free-silica, cyanide, arsenic, lead and other toxins and avoid use when these toxic, harmful substances are present.
- SURFACE TO BE BLASTED** should be examined for hazardous substances. Take appropriate protective measures as required by OSHA to ensure the blast operator, other workers in the vicinity, and any bystanders are properly protected.

©Clemco Industries Corp., Stock No. 20954P, 0692 Rev. F, 06/12

1.0 INTRODUCTION

1.1 Scope

1.1.1 This manual covers the preparation, operation, maintenance, troubleshooting, and replacement parts for Clemco's CAT Cool-Air Tube. The cool-air tube is used to cool compressed respirable air supplying an Apollo supplied-air respirator or Comfort Vest. Read this manual and the appropriate Apollo HP (high pressure) respirator manual and/or Comfort Vest manual before using the cool-air tube.

1.1.2 The National Institute for Occupational Safety and Health (NIOSH) approval and Occupational Safety & Health Administration (OSHA) regulations cited within this manual apply when the cool-air tube is used to provide air to a supplied-air respirator. The regulations do not apply if the cool-air tube is used with a Comfort Vest alone. When a vest is used with a respirator having a cape that extends over the vest, air from the vest could be ingested by the user. For that reason, Grade D air or higher quality, as defined in Section 2.1 of this manual, must be provided to both the respirator and vest.

1.2 Safety Alerts

1.2.1 Clemco uses safety alert signal words, based on ANSI Z535.4-2011, to alert the user of a potentially hazardous situation that may be encountered while operating this equipment. ANSI's definitions of the signal words are as follows:



This is the safety alert symbol. It is used to alert you to potential physical injury hazards. Obey all safety messages that follow this symbol to avoid possible injury or death.

NOTICE

Notice indicates information that is considered important, but not hazard-related, if not avoided, could result in property damage.

CAUTION

Caution indicates a hazardous situation that, if not avoided, could result in minor or moderate injury.

WARNING

Warning indicates a hazardous situation that, if not avoided, could result in death or serious injury.

DANGER

Danger indicates a hazardous situation that, if not avoided, will result in death or serious injury.

1.3 NIOSH Approval

1.3.1 The CAT Cool-Air Tube is approved by NIOSH to use with Clemco Apollo respirators.

1.3.2 The NIOSH label shown below lists the Apollo respirator approval numbers. An X on the approval line indicates which components are approved for the specific respirator. Do not use any non-approved components with the respirator.

Clemco Industries Corp.
Washington MO, USA
(636) 239-0300

TYPE C AND CE CONTINUOUS FLOW SUPPLIED-AIR RESPIRATOR IS APPROVED ONLY IN THE FOLLOWING CONFIGURATIONS:

TC#	Protection ¹	Part No.	Model	Respirator Components								Cautions and Limitations ²					
				Helmets		Alternate Regulators			Hose Air Lines								
				Apollo 60	Apollo 600	Apollo 20	CAT	CCT	Clem-Cool A/C	CFC/High Pressure	CFC/Low Pressure		ACV	Yellow 3/8" x 25 FL	Yellow 3/8" x 50 FL	Yellow 3/8" x 100 FL	Black 1/2" x 100 FL
19C-338	CF/SA		10506														BCDEJM NOS
19C-339	CF/SA		23824														BCDEJM NOS
19C-130	CF/SA		21302	X	X												BCDEJM NOS
19C-358	CF/SA		04410	X	X												BCDEJM NOS

1 PROTECTION
CF - Continuous Flow SA - Supplied-air

2 CAUTIONS AND LIMITATIONS

B- Not for use in atmospheres immediately dangerous to life or health.
 C- Do not exceed maximum use concentrations established by regulatory standards.
 D- Air-line respirators can be used only when the respirators are supplied with respirable air meeting the requirements of CGA G-7.1 Grade D or higher quality.
 E- Use only the pressure ranges and hose lengths specified in the user's instructions.
 J- Failure to properly use and maintain this product could result in injury or death.
 M- All approved respirators shall be selected, fitted, used, and maintained in accordance with MSHA, OSHA, and other applicable regulations.
 N- Never substitute, modify, add, or omit parts. Use only exact replacement parts in the configuration as specified by the manufacturer.
 O- Refer to users instructions, and/or maintenance manuals for information on use and maintenance of these respirators.
 S-Special or critical users instructions, and/or specific use limitations apply. Refer to instruction manual before donning.

⚠ WARNING

NIOSH approval applies to items shown on the label when used as a complete system. Do not make any non-approved modification, deletion, or substitution. Non-approved components void the NIOSH approval and may permit ingress of toxic and hazardous dust, resulting in toxic poisoning and respiratory disease.

1.4 OSHA Regulations

1.4.1 OSHA Regulation 29 CFR 1910.134 for respiratory protection in General Industry is referenced throughout this document. Respiratory protection standards for Construction 29 CFR 1926.103 and for Maritime 29 CFR-1915.154, 1917, and 1918 refer to 1910.134. The complete regulation is available through the U.S. Dept. of Labor web site at www.osha.gov.

1.4.2 OSHA Regulations 29 CFR 1910.134(a) and (c) require the employer to establish and maintain a comprehensive, written, respiratory protection program administered by a suitably-trained program administrator. The program must include, but is not limited to the following:

1. Procedures for selecting NIOSH-certified respirators.
2. Medical evaluations of employees required to use respirators.
3. Fit testing procedures.
4. Procedures for proper use of respirator in routine and foreseeable emergency situations.
5. Procedures and schedules for cleaning, disinfecting, storing, inspecting, repairing, discarding and otherwise maintaining respirators.
6. Procedures to ensure adequate air quality, quantity and flow of breathing air for atmosphere-supplying respirators.
7. Training of employees in the respiratory hazards to which they are potentially exposed during routine and emergency situations.
8. Training of employees in the proper use of the respirators, including putting on and removing them, any limitations on their use, and their maintenance.
9. Procedures for regularly evaluating the effectiveness of the program.

1.4.3 It is essential that the user be properly instructed in the use and maintenance of the respirator. The respirator manual and this manual for the cool-air tube must be made available to all users of the respirator, and the users must demonstrate their understanding of its subject matter. Read the entire manual before installing or operating the equipment.

1.4.4 The cool-air tube must be supplied with respirable air meeting requirements described herein. It is the responsibility of the employer to provide quality breathing-air to the respirator, and to establish a program to ensure that the respirator and accessories are properly used and maintained.

1.5 Description

1.5.1 The CAT Cool-Air Tube is an approved alternate air control valve, which provides the user with a source of cool air when used in conjunction with a Clemco supplied-air respirator or Comfort Vest. The illustration in Figure 1 shows components and controls for the cool-air tube.

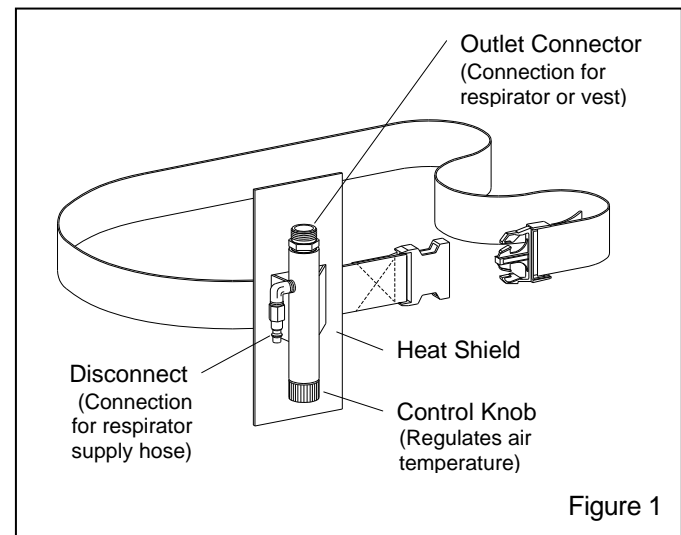

2.0 AIR SUPPLY

2.1 Air Quality

⚠ DANGER

Never connect a breathing air line to an air source that has not been tested for gas and particulate contamination. The presence of unacceptable levels of carbon monoxide (CO) or other gases, or oxygen deficiency in breathing air will cause death to the user.

2.1.1 The employer is responsible for ensuring that breathing air shall meet the requirements for Grade D or higher quality, as described in Compressed Gas Association Commodity Specification pamphlet G-7.1., titled Commodity Specification For Air, published by Compressed Gas Association Inc., Chantilly, VA. Website: www.cganet.com, (29 CFR 1910.134 (i)).

2.1.2 Limiting characteristics of Grade D air, as of the publication of this manual is as follows:

- Carbon Dioxide maximum of 1000 ppm
- Carbon Monoxide maximum of 10 ppm
- Odor *No pronounced odor
- Oil (hydrocarbons)maximum of 5 mg/m³
- Oxygenbetween 19.5 - 23.5%

* Specific measurement of odor in gaseous air is impractical. Air may have a slight odor but the presence of a pronounced odor renders the air unsatisfactory.

2.1.3 Special care must be taken to avoid accidental connection to any lines other than compressed air; such as, oxygen, acetylene, or nitrogen.

2.1.4 When the cool-air tube is used for breathing air, the quality of air supplied to the cool-air tube is extremely critical to the safety of the user.

2.1.5 Any air ingested from the cool-air tube must meet the requirement for respirable air as stated herein. If the cool-air tube supplies air to a vest that is used with a hooded respirator, air supplied to the vest must also be respirable air meeting the requirements for Grade D or better.

2.1.6 Prior to using the respirator, read the owner's manual and all instructions, labels, and warnings relating to the compressed air source. Take special care to abide by all warnings from the compressor manufacturer regarding compressor use, and from the cylinder and air supplier, for breathing air cylinders and their use.

2.1.7 A Clemco CPF filter may be installed and regularly maintained to remove objectionable odors, oil mist, water, pipe scale, and other particulate matter.

2.2 Breathing-Air from Cylinders

DANGER

Operators must never use or operate breathing air cylinders, without proper pressure reducing devices, and training on their use. Breathing cylinders are under extremely high air pressure. Improper use could cause cylinders or accessories to rupture, resulting in severe injury or death.

2.2.1 Using cylinders (high-pressure air bottles) requires special knowledge of their use and compliance with OSHA Regulations. Refer to 29 CFR 1910.134(h) and (i) and 49 CFR part 173, and part 178.

2.2.2 The employer shall ensure that cylinders used to supply breathing air to respirators meet all requirements which may include, but are not limited to, their testing and maintenance, a certificate of analysis for air quality and moisture.

2.2.3 Cylinders must be equipped with a properly maintained pressure-reducing valve that reduces pressure to the approved pressure range as shown in Section 2.4.3.

2.3 Breathing-Air from Compressors

2.3.1 The employer shall ensure that air from compressors used to supply breathing air to respirators meets the requirements in 29 CFR 1910.134.(i)(5).

2.3.2 Precautions must be taken to prevent contaminants from entering through the compressor intake: Ref. 29 CFR 1910.134.(i)(5)(i). The compressor inlet must be located away from all sources of toxic contaminants including carbon monoxide, which is found in engine exhaust (including the exhaust from the compressor's engine), and in any form of combustion. No vehicles should be allowed near the compressor intake. Contaminants can enter respiratory equipment through the compressor air inlet. This inlet must not be located near any exhaust system outlet, ventilation flue, or source of fumes or particles of any kind.

2.3.3 The compressed-air supply system must be equipped with suitable in-line air-purifying sorbent beds and filters, and be maintained to further ensure breathing air quality: 29 CFR 1910.134 (iii).

2.3.4 If the breathing-air supply is from a non-oil-lubricated compressor, the employer shall ensure that the carbon monoxide levels in the breathing air do not exceed 10 ppm: 29 CFR 1910.134 (i)(6).

2.3.5 If an oil-lubricated compressor is used, the employer shall use a high-temperature alarm or carbon monoxide (CO) alarm, or both, to monitor carbon monoxide levels. If only high-temperature alarms are used, the air supply shall be monitored at intervals sufficient to prevent carbon monoxide in the breathing air from exceeding 10 ppm: 29 CFR 1910.134 (i)(7).

2.4 Operating Pressure

2.4.1 Air pressure at the point of attachment (the point of attachment is where the respirator supply hose is connected to the respirable air source) must be maintained at pressures between 90 to 100 psi (pounds per square inch), as shown in the table in Section 2.4.3. Maintaining the correct operating pressure at the point of attachment ensures the correct air flow to the respirator.

2.4.2 The Clemco CPF Inline Particulate Filter with regulator meets this requirement for a regulator and gauge, provided inlet pressure does not exceed 150 psi.

! DANGER

Do not connect the cool-air tube, CPF Filter, or any other regulator or filter, to bottled air that does not have a pressure reducing valve that reduces pressure to the maximum operating pressure of the respirator or filter it services. Failure to comply with this warning will cause devices rated at lower pressures to rupture under the high pressure of bottled air, which could cause severe injury or death.

2.4.3 Use the following table to determine the minimum pressure setting and maximum respirator hose length that may be used with the cool-air tube. Adjust the pressure with the respirator hose and respirator attached. If the regulator is adjusted with static pressure (no air flow), pressure may drop below the required pressure when the respirator is connected, and may result in low air flow. Setting the pressure as shown provides a minimum of 7 cfm (cubic feet per minute) to the respirator. The maximum allowable pressure for use with the cool-air tube is 100 psi.

Minimum Pressure	Overall hose length measured in feet							
	25	50	75	100	125	150	175	200
90 psi	x	x	x					
95 psi				x	x	x	x	x

The maximum overall hose length used with the cool-air tube is 200 feet when providing air to a respirator.

2.5 Air Volume

2.5.1 The cool-air tube must be supplied with 20 cfm of Grade D breathing air at 90 to 100 psi.

! WARNING

The compressor must provide adequate output and the plumbing between the compressor and the point of attaching the respirator hose must have sufficient capacity to supply the volume of air at the pressure required. Restricted air flow will cause discomfort to the user, and may result in ingress of hazardous and toxic dust, subjecting the user to health and life threatening toxic poisoning and long term respiratory disease and death.

3.0 SET-UP and ADJUSTMENTS

3.1 Attach Breathing Tube Assembly

! WARNING

Note the directional flow arrows on the labels at both ends of the breathing tube. The flow arrows indicate the direction of air flow to the helmet. Flow arrows must point toward the helmet. Failure to properly attach the breathing tube may damage the tube's acoustical foam, which will block air flow, or it may increase noise levels beyond OSHA limits.

3.1.1 The breathing tube has a clamped-on end and a molded-on end. Attach the molded-on swivel connector to the cool-air tube's outlet as shown in Figure 2.

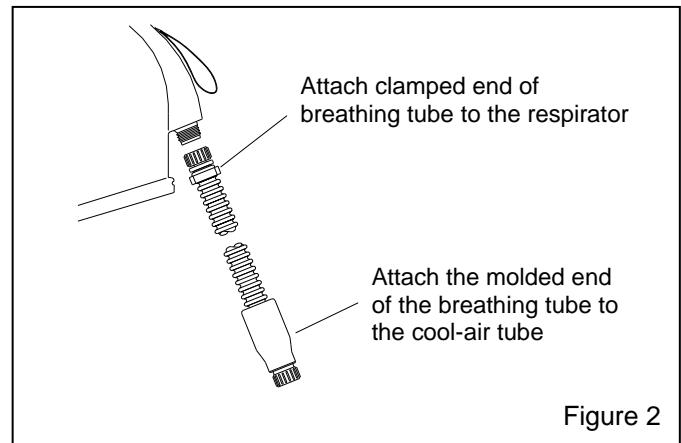

Figure 2

3.1.2 Attach the clamped-on end to the threaded air inlet fitting at the back of the helmet as shown in Figure 2. Do not over-tighten; hand-tight is sufficient.

3.1.3 Attach an approved Clemco respirator hose to the quick-disconnect nipple.

3.2 Air Supply and Pressure

3.2.1 Initiate the air supply and regulate air pressure between 90 and 100 psi, as shown in Section 2.4.3.

3.3 After donning the respirator, securely attach the belt and cool-air tube around the waist. Adjust the belt size as required.

3.4 Adjust Air Temperature

3.4.1 To adjust air temperature, rotate the temperature control knob (shown in Figure 3) located on the bottom of the cool-air tube, toward the broader, darker end of the arrow for ambient temperature or toward narrower, lighter end for maximum cooling. The knob may be positioned anywhere in between to attain the most comfortable temperature setting.

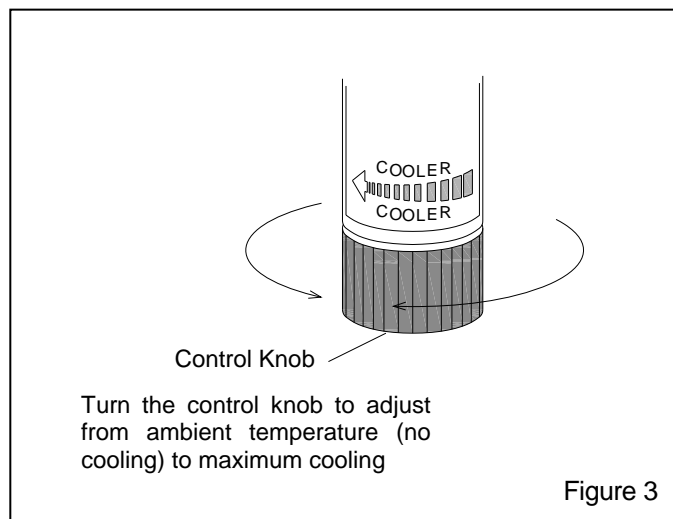

4.0 PREVENTIVE MAINTENANCE

4.1 Air Filter Screen

4.1.1 Inspect and clean the air filter screen monthly. If inadequate air flow is experienced, stop using the cool-air tube and inspect the screen for blockage.

NOTICE

Debris or abrasion on the screen is one indication of dirty air. Dirty air will cause rapid erosion of critical parts of the cool-air tube, which will decrease efficiency and life of the air tube.

4.1.2 To clean the air filter screen, unscrew the quick disconnect nipple from the inlet elbow. Turn the elbow upside down and tap it on a solid surface to remove loose debris. The screen can be removed by tapping the elbow described above. If the screen is wedged in place it may be necessary to destroy it in order to remove. Replace the screen before reassembly.

5.0 SERVICE MAINTENANCE

5.1 O-Rings Replacement

5.1.1 Replace o-rings when air leaks are detected.

5.1.2 Replace the o-ring in the cool-end venturi by following instructions in Section 5.2 (cool-end venturi).

5.1.3 Replace o-rings on the valve stem assembly by following instructions in Section 5.3 (vortex tube assembly).

5.2 Cool-End Venturi, Figure 4

5.2.1 Clean and inspect the cool-end venturi every 4-6 weeks. Clean all parts with soap and water only, and thoroughly rinse.

5.2.2 Unscrew the outlet connector from the top of the cool-air tube. Grasp the stem of the cool-end venturi and pull to remove the assembly (cool-end venturi, o-ring, spring washers and back-up washer).

5.2.3 Gently clean the slots on the venturi with a brush or small screwdriver. If the slots are worn, replace the assembly. Look into the cool-air tube body to inspect the top surface of the spacer for wear. If dirty or worn, continue to Paragraph 5.3 before replacing the cool-end venturi assembly. Otherwise, replace the venturi assembly making sure the cone side of the spring washers face each other. Apply thread sealant to the body end of the outlet connector and secure it tightly with a wrench. A loose connection will reduce performance.

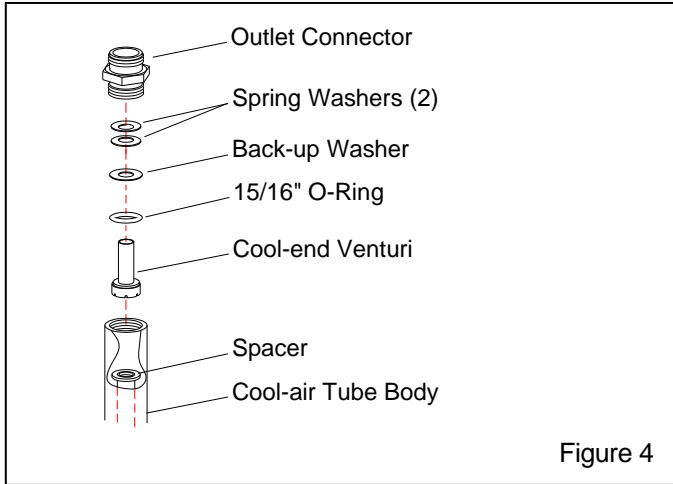

Figure 4

5.3 Vortex Tube Assembly, Figure 5

5.3.1 Remove the cool-end venturi per Section 5.2. Remove the inlet elbow, and temperature control knob. Using a pencil or similar object, gently push the valve stem from the bottom of the body. Continue to push the entire vortex tube assembly through the top of the body. Inspect the inside of the tube body to make sure the 11/16" o-ring is removed.

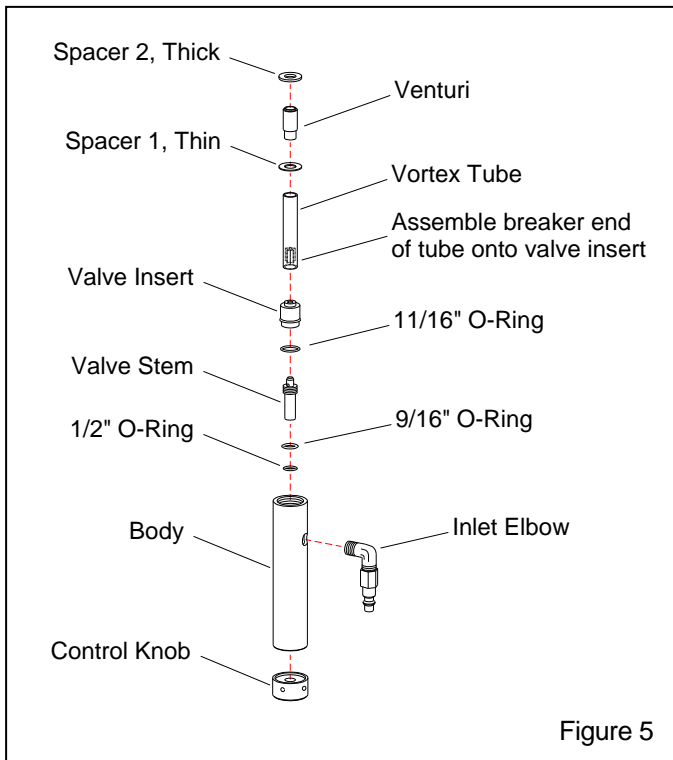

Figure 5

5.3.2 Unscrew the valve stem from the valve insert and remove the two o-rings.

5.3.3 Clean all parts with soap and water only and thoroughly rinse.

5.3.4 Lubricate the valve stem threads with silicone grease and screw it fully, finger-tight, into the valve insert. Lubricate new o-rings. Slide the 9/16" and 1/2" o-rings onto the stem, with the larger of the two toward the insert. Put a new o-ring on the insert and reassemble the vortex tube assembly and cool-air tube as shown in Figures 4 and 5. **NOTE: One end of the vortex tube has a metal "vortex breaker" in it. Inspect the breaker for wear or damage. Reassemble, making sure the valve insert and stem are installed on the breaker end of the tube.** To ease assembly of the vortex tube assembly, assemble it as shown in Figure 5, turn the body upside down and insert the assembly into the body

5.4 Belt Bracket Screws

5.4.1 If for any reason the belt bracket screws are removed, reinstall them using thread sealant to prevent air leaks.

6.0 TROUBLESHOOTING

6.1 Inadequate Air Flow

6.1.1 Check filter screen for debris.

6.1.2 Make sure supply air pressure is between 90 to 100 psi. A pressure regulator and gauge must be installed at the point of attachment (where the respirator hose is connected to the respirable air source).

6.2 Poor Cooling Performance

6.2.1 Inadequate air flow affects cooling performance. Refer to Paragraph 6.1.

6.2.2 The temperature of the compressed air has an effect on the cool-air tube's discharge temperature. Make sure that none of the lines that supply compressed air to the cool-air tube is routed near any source of heat, such as a steam radiator, furnace, etc. When possible, avoid exposure to direct sunlight.

6.2.3 Erosion of internal parts: Compressed air moving through the air tube will eventually wear critical components. Dirty air accelerates wear of internal parts.

6.2.4 Vortex breaker may be loose, worn, or damaged. Inspect the breaker per Section 5.3.1.

7.0 REPLACEMENT PARTS, Figure 6

Item	Description	Stock No.
(-)	CAT Cool-air tube assembly w/ belt	04410
1.	Belt	04430
2.	Disconnect nipple	08449
3.	Elbow, 1/4" male	08869
4.*	Seal kit (o-rings)	08870
5.*	Venturi kit, cool-end	08871
6.	Stem, valve	08962
7.	Insert, valve	08963

8.	Vortex tube with breaker	23030
9.	Spacer 1, thin	08966
10.	Venturi tube	08967
11.	Spacer 2, thick	08968
12.	Connector, outlet	08971
13.	Screen	08983
14.	Heat shield	08981
15.	Knob w/set screws	08985
16.	Body	08961
17.	Screw, machine 10-24 x 1/4", r/h (each)	08980
18.	Bracket, belt	08974

* Items 4 and 5 include the cool-end o-ring. If both items are ordered together, you will receive an extra o-ring.

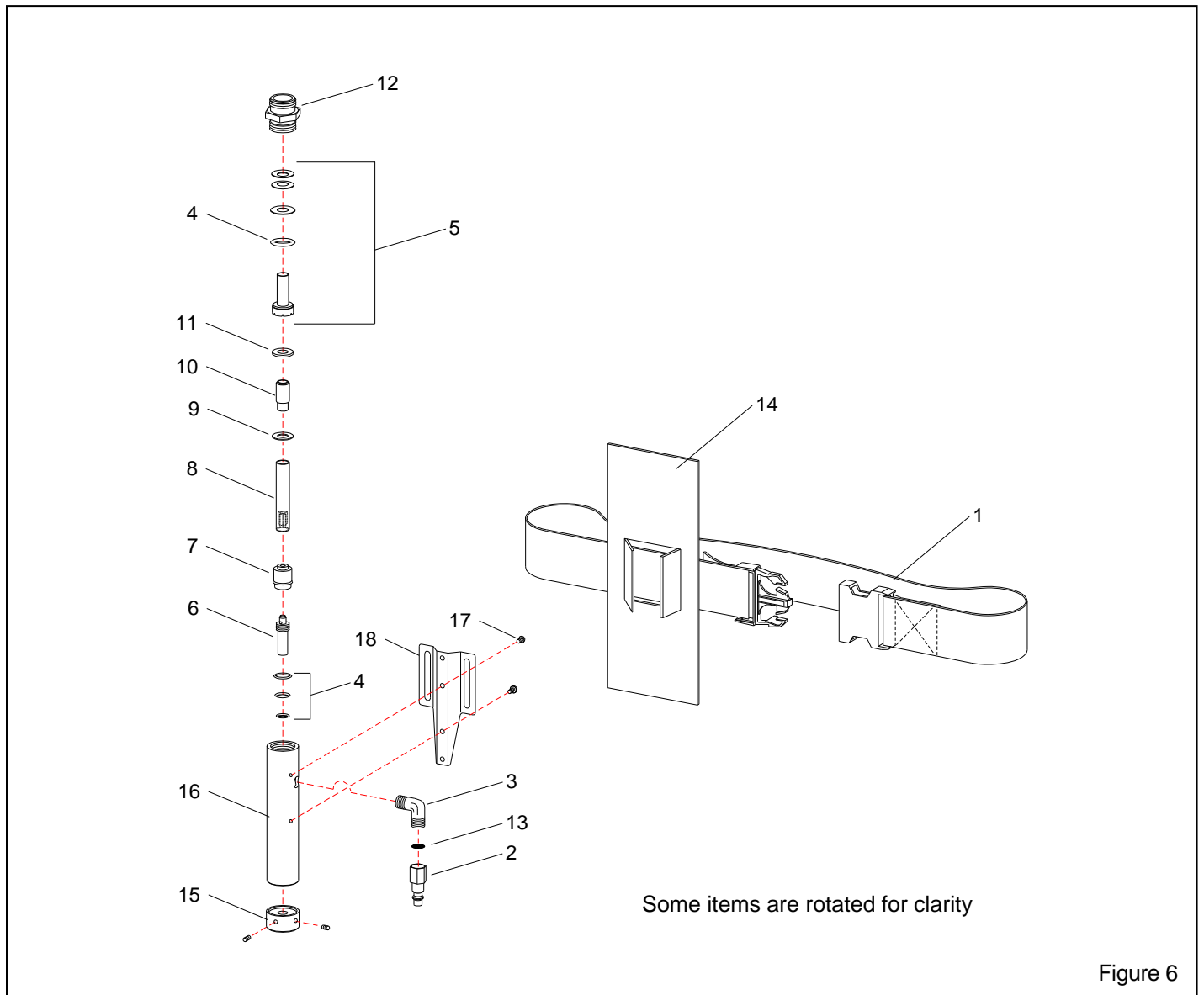

Figure 6