



SPECTRUM SERIES®



PART NUMBERS AND SCHEMATICS GUIDE

Company Profile

Since 1944, Marco has developed a strong tradition of providing innovative and reliable products and services to the surface preparation and protective coatings industries. We are the world's premier provider of Abrasives, Blasting, Coating, Dust Collectors, Engineered Systems, Rental, Safety, Service, Repair, & Modernization, and Vacuums.

Through innovative designs and a total commitment to quality, Marco manufactures products that increase production rates, create a safer workplace, and reduce maintenance costs. Marco's industry experience, manufacturing capabilities, legendary customer service, product availability, logistics services, and technology leadership is your assurance that we deliver high quality products and services, providing the best value to you, our customer.

The Marco Difference

- **Industry Experience** – With Marco on your team, you have access to expertise which can only come from decades of industry leadership. We have organized our engineering department, production specialists, customer operations, and safety support into a “Center of Competence.” As a Marco customer, you have access to hundreds of years of cumulative experience related to your operations.
- **Manufacturing Excellence** – Marco is a U.S. based, ISO 9001:2008 certified manufacturer of equipment for the Surface Preparation and Protective Coatings industries. Marco's engineers benchmark the industry to ensure that we design and manufacture superior products that set the “Gold Standard” for performance, safety, and quality.
- **Legendary Customer Service** – Marco's legendary customer service team is staffed by friendly, highly-trained individuals who are focused on providing the highest level of product support, order accuracy, and customer satisfaction.
- **Product Availability** – We stock over 10,000 SKU's and have more than 45 shipping locations to serve North American and International markets for all major brands of blasting and coating equipment. As the largest provider of surface preparation and protective coatings equipment in the world, our inventory levels and product availability are unmatched.
- **Logistics Services** – Marco's in-house logistics team is dedicated to moving your shipment anywhere in the world. We move more than 14,000 truckloads every year, allowing you to save on freight costs by leveraging our buying power. Lower your process costs with a single invoice, which includes product and freight.
- **Technology Leadership** – Our website provides: Operator's Manuals, Part Numbers and Schematics Guides, SDS information, and Features & Specifications Guides, providing access to information 24/7. Our Extranet application allows you to receive quotes and place orders online. Our Intranet maintains a complete record of your purchase history to assist with ongoing support of your existing equipment and future purchasing decisions.

Vision Statement

Marco is the world's premier provider of Abrasives, Blasting, Coating, Dust Collectors, Engineered Systems, Rental, Safety, Service, Repair, & Modernization, and Vacuums.

Mission Statement

Marco provides strong leadership and innovation to the surface preparation and protective coatings industries. We dedicate our efforts to the continuous improvement of our products, services, processes, people, and most importantly, the quality of our customer's experience.

Quality Statement

Marco is committed to providing superior quality in the design, manufacturing, distribution, rental, service, and repair of our products. Our ISO 9001:2008 certification extends throughout all operations in all locations. Continuous improvement of our processes and supply chain Integration comprise the core of our business strategy for delivering exceptional quality and value in all Marco products and services.

Management Philosophy

We are a company dedicated to the success of every customer and associate. We discuss, debate, challenge, measure, and test our ideas. We will be boundless and limitless in our passion to improve. Through sound leadership and dedicated associates, we will ensure a long term, profitable future for Marco, our associates, customers, and suppliers.

TABLE OF CONTENTS

Company Profile	2
Table of Contents	3
Bullard® Spectrum Series®	4-11
Full Face Mask – Small	4
Full Face Mask – Medium/Large	5
Part Numbers and Schematics.....	6-7
Free-Air® Pump Respirator Assemblies	8
Replacement Face Pieces	8
Replacement Breathing Tubes	8
Breathing Air Supply Hose – 3/8"	9
Breathing Air Supply Hose – 1/4"	9
Flow Control Device	10
Replacement Items and Accessories	11

PART NUMBERS AND SCHEMATICS GUIDE



Part Numbers

BULLARD® SPECTRUM SERIES® FULL FACE MASK – SMALL		
	Size	Flow Control Device
10BSPEC3xS*	Small	Continuous Flow Assembly
10BSPEC4xS*	Small	Adjustable Flow Assembly
10BSPECCT3xS*	Small	CT Series Cool Tube Assembly
10BSPECCT30SWS	Small	CT Series Cool Tube Assembly with Swivel
10BSPECAC10003xS*	Small	AC1000 Series Cool Tube Assembly
10BSPECHCT3xS*	Small	HCT Series Hot/Cool Tube Assembly
10BSPECHCT30SWS	Small	HCT Series Hot/Cool Tube Assembly with Swivel
10BSPECHCT30SWS	Small	HCT Series Hot/Cool Tube
10BSPECHC24003xS*	Small	HC2400 Series Hot/Cool Tube Assembly

*Replace "x" with number corresponding to desired nipple type:

- 1 – Industrial Interchange
- 2 – Schrader
- 3 – Snap-Tite
- 4 – Snap-Tite Brass
- 7 – Snap-Tite Stainless
- 8 – Bayonet

**Assemblies include full-face mask, regulator, quick-disconnect coupler, and belt

PART NUMBERS AND SCHEMATICS GUIDE



Part Numbers

BULLARD® SPECTRUM SERIES® FULL FACE MASK – MEDIUM/LARGE		
	Size	Flow Control Device
10BSPEC3xL*	Medium/Large	Continuous Flow Assembly
10BSPEC4xL*	Medium/Large	Adjustable Flow Assembly
10BSPECCT3xL*	Medium/Large	CT Series Cool Tube Assembly
10BSPECCT30SWL	Medium/Large	CT Series Cool Tube Assembly with Swivel
10BSPECAC10003xL*	Medium/Large	AC1000 Series Cool Tube Assembly
10BSPECHCT3xL*	Medium/Large	HCT Series Hot/Cool Tube Assembly
10BSPECHCT30SWL	Medium/Large	HCT Series Hot/Cool Tube Assembly with Swivel
10BSPECHCT30SWL	Medium/Large	HCT Series Hot/Cool Tube
10BSPECHC24003xL*	Medium/Large	HC2400 Series Hot/Cool Tube Assembly

*Replace "x" with number corresponding to desired nipple type:

- 1 – Industrial Interchange
- 2 – Schrader
- 3 – Snap-Tite
- 4 – Snap-Tite Brass
- 7 – Snap-Tite Stainless
- 8 – Bayonet

**Assemblies include full-face mask, regulator, quick-disconnect coupler, and belt

PART NUMBERS AND SCHEMATICS GUIDE

Spectrum Airline Respirator

Item #	Part #	Description
Fig. 1		
1	10BLCK	Lens Clamp Replacement Kit
2	10BRLS	Replacement Lens
3	10BFKS	Small Face Piece Flange
4	10BHSK	Head Strap Kit
5	10BMCK	Mask Cover
6	—	Speaker Diaphragm*
7	—	Outer Locking Ring*
8	—	O-Ring Speaker Diaphragm*
9	—	O-Ring Speaker/Exhalation*
10	—	Speaker/Exhalation Body*
11	10B6059	Exhalation Valve (<i>Quantity of Five</i>)
12	—	O-Ring for Exhalation Valve Seat
13	10BEVO	Exhalation Valve Seat (<i>Includes Item #12</i>)
14	10BLNK	Nosecup (<i>Includes Item #15</i>)
15	—	Inhalation Valve Seat (<i>Quantity of Two</i>)
16	10BSPECBT	Breathing Tube
17	10BF30B	1/4" Constant Flow Fitting
18	10BF40B	1/4" Adjustable Flow Control Valve
19	10BAC1000	1000 Series Hood Air Conditioner with Belt
20	10BCT	CT Series Cool Tube
21	10BHC2400	2400 Series Helmet Hot/Cold Tube with Belt
22	10BHCT30	HCT Series Helmet Hot/Cold Tube with Belt
23	10BLC	Mylar Lens Cover (<i>25/Package</i>)
—	10BSEK	Speaker Exhalation Kit (<i>Includes Item #'s: 6, 7, 8, 9, and 10</i>)
—	306V641	Brochure – Bullard® Spectrum Series
—	309V106	Operator's Manual – Bullard® Spectrum Series

*Not available individually, order kit 10BSEK

PART NUMBERS AND SCHEMATICS GUIDE

Figure 1: Spectrum Airline Respirator

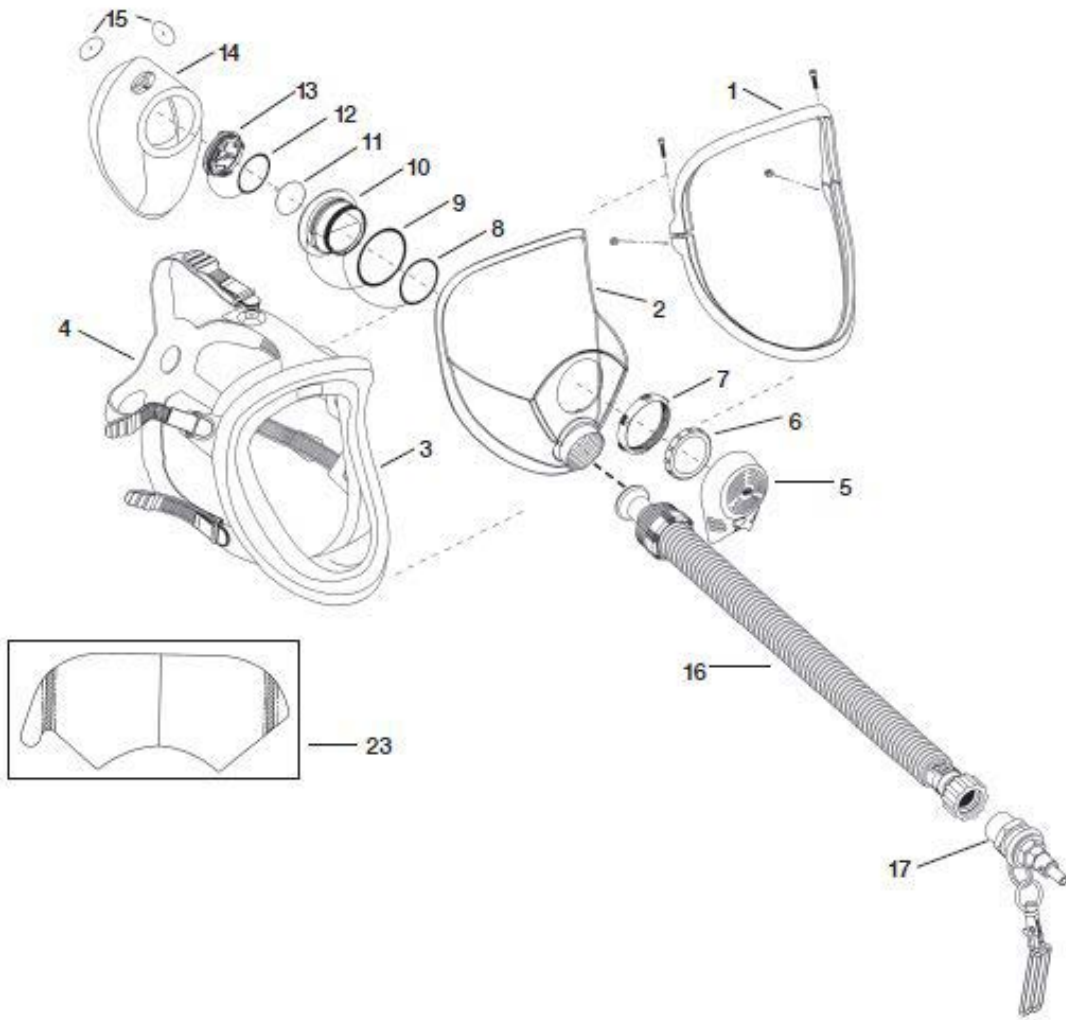

PART NUMBERS AND SCHEMATICS GUIDE



FREE-AIR® PUMP RESPIRATOR ASSEMBLIES			
	Part Numbers	Description	Size
	10BSPEC35S	Continuous Flow Assembly with 1/2" Industrial Interchange Nipple	Small
	10BSPEC35L	Continuous Flow Assembly with 1/2" Industrial Interchange Nipple	Large/Medium

**Assemblies for use with Bullard® Free-Air® Pumps*



REPLACEMENT FACE PIECES			
	Part Numbers	Description	Size
	10BSPECCFS	Face Piece Assembly	Small
	10BSPECCFML	Face Piece Assembly	Large/Medium

REPLACEMENT BREATHING TUBES			
	Part Numbers	Description	
	10BSPECBT	Spectrum Breathing Tube	

PART NUMBERS AND SCHEMATICS GUIDE









	Part Numbers	BREATHING AIR SUPPLY HOSE – 3/8" I.D.
		Description
	10B4696	25' x 3/8" I.D. Breathing Line Starter Hose Kit
	10B469650	50' x 3/8" I.D. Breathing Line Starter Hose Kit
	10B4696100	100' x 3/8" I.D. Breathing Line Starter Hose Kit
	10B5454	25' x 3/8" I.D. Breathing Line Extension
	10B5457	50' x 3/8" I.D. Breathing Line Extension
	10B5458	100' x 3/8" I.D. Breathing Line Extension

**For use with Compressed Air*

	Part Numbers	BREATHING AIR SUPPLY HOSE – 1/4" I.D.
		Description
	10BV2050ST	50' Flow Thru Starter Hose
	10BV20100ST	100' Flow Thru Starter Hose
	10BV2025STSHUTOFF	25' Shutoff Starter Hose

**For use with Bullard® Free-Air® Pumps*

PART NUMBERS AND SCHEMATICS GUIDE



Part Numbers	FLOW CONTROL DEVICE	
	Description	
	10BF3x*	Continuous Flow
	10BF4x*	Adjustable Flow
	10BCT3x*	CT Series Cool Tube
	10BCT30SW	CT Series Cool Tube with Swivel
	10BAC10003x*	AC1000 Series Cool Tube
	10BHCT3x*	HCT Series Hot/Cool Tube
	10BHC30SW	HCT Series Hot/Cool Tube with Swivel
	10BHC24003x*	HC2400 Series Hot/Cool Tube

**Replace "x" with number corresponding to desired nipple type:*

- 1 – Industrial Interchange*
- 2 – Schrader*
- 3 – Snap-Tite*
- 4 – Snap-Tite Brass*
- 7 – Snap-Tite Stainless*
- 8 – Bayonet*

***Flow Control Devices include 10B4612 Nylon Belt*

PART NUMBERS AND SCHEMATICS GUIDE

	Part Numbers	REPLACEMENT ITEMS AND ACCESSORIES
		Description
	10BQNFT45	Quantitative Fit Test Kit
	10BFTR45	Fit Test Refill Kit
	10BHFC45	HEPA Cartridge for Fit Test (4/Package)
	10BLCK	Lens Clamp Replacement Kit
	10BRLS	Spectrum Replacement Lens
	10BFKML	Face Piece Flange – Medium/Large
	10BFKS	Face Piece Flange – Small
	10BHSK	Head Strap Kit <i>(Includes 5 Buckles and Slides)</i>
	10BMCK	Mask Cover Kit
	10BSEK	Speaker Diaphragm Kit
	10BEVO	Exhalation Valve Kit <i>(Includes Valve Seat and O-Ring)</i>
	10BLNK	Nose Cup Kit <i>(Includes 2 Inhalation Valve Flaps)</i>
	10B6059	Exhalation Valves (5/Package)
	10BAFW45	Anti-Fog Wipes (10/Package)
	10BPL	Spectacle Frame Assembly
	10BLC	Mylar Lens Covers (25/Package)
	10BSPECIVK	Inhalation Valve Kit (5/Package)

GLOBAL HEADQUARTERS

- 3425 East Locust Street
Davenport, IA 52803

ph: 800.BLAST.IT (800.252.7848)
ph: 563.324.2519
fax: 563.324.6258

REGIONAL BRANCH OFFICES

- **Iowa**
Davenport
- **Louisiana**
Gonzales
Harvey
Lafayette
- **Ohio**
Youngstown
- **Texas**
Beaumont
Corpus Christi
Deer Park

40+ NATIONWIDE SHIPPING LOCATIONS



★ Marco Regional Branch Offices and Shipping Locations ● Direct Shipping Locations



ABRASIVES

BLASTING

COATING

DUST COLLECTORS

ENGINEERED SYSTEMS

RENTAL

SAFETY

SERVICE, REPAIR, & MODERNIZATION

VACUUMS

CONTACT MARCO

800.BLAST.IT
(800.252.7848)
563.324.2519
FAX: 563.324.6258

WWW.MARCO.US
SALES@MARCO.US