

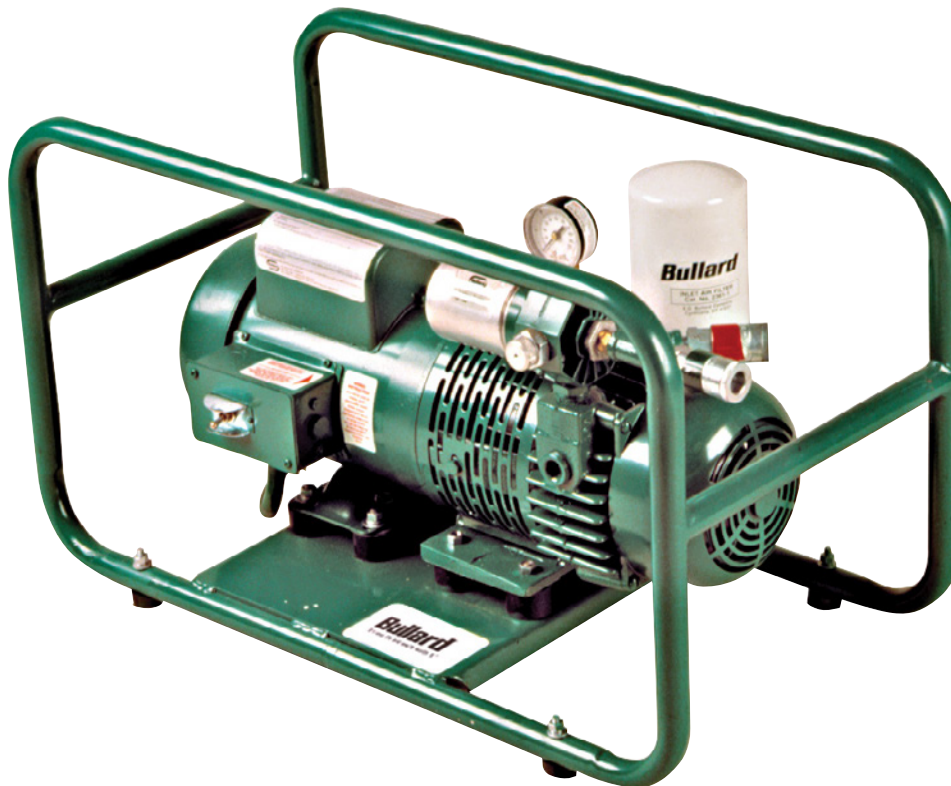

## EDP 16HAZ FREE-AIR® PUMP



**PART NUMBERS AND SCHEMATICS GUIDE**

## Company Profile

Since 1944, Marco has developed a strong tradition of providing innovative and reliable products and services to the surface preparation and protective coatings industries. We are the world's premier provider of Abrasives, Blasting Equipment, Coating Equipment, Engineered Systems, Rental Equipment, Safety Equipment, Service, and Repair.

Through innovative designs and a total commitment to quality, Marco manufactures products that increase production rates, create a safer workplace, and reduce maintenance costs. Marco's industry experience, manufacturing capabilities, legendary customer service, product availability, logistics services, and technology leadership is your assurance that we deliver high quality products and services, providing the best value to you, our customer.

## The Marco Difference

- **Industry Experience** – With Marco on your team, you have access to expertise which can only come from decades of industry leadership. We have organized our engineering department, production specialists, customer operations, and safety support into a "Center of Competence." As a Marco customer, you have access to hundreds of years of cumulative experience related to your operations.
- **Manufacturing Excellence** – Marco is a U.S. based, ISO 9001:2008 certified manufacturer of equipment for the Surface Preparation and Protective Coatings industries. Marco's engineers benchmark the industry to ensure that we design and manufacture superior products that set the "Gold Standard" for performance, safety, and quality.
- **Legendary Customer Service** – Marco's legendary customer service team is staffed by friendly, highly-trained individuals who are focused on providing the highest level of product support, order accuracy, and customer satisfaction.
- **Product Availability** – We stock over 10,000 SKU's and have over 45 shipping locations to serve North American and International markets for all major brands of blasting and painting equipment. As the largest provider of surface preparation and protective coatings equipment in the world, our inventory levels and product availability are unmatched.
- **Logistics Services** – Marco's in-house logistics team is dedicated to moving your shipment anywhere in the world. We move over 14,000 truckloads every year, allowing you to save on freight costs by leveraging our buying power. Lower your process costs with a single invoice, which includes product and freight.
- **Technology Leadership** – Our website provides: Operator's Manuals, Part Numbers and Schematics Guides, MSDS information, and Features and Specifications Guides, providing access to information 24/7. Our Extranet application allows you to receive quotes and place orders online. Our Intranet maintains a complete record of your purchase history to assist with ongoing support of your existing equipment and future purchasing decisions.

## Vision Statement

Marco is the world's premier provider of Abrasives, Blasting Equipment, Coating Equipment, Engineered Systems, Rental Equipment, Safety Equipment, Service, and Repair.

## Mission Statement

Marco provides strong leadership and innovation to the surface preparation and protective coatings industries. We dedicate our efforts to the continuous improvement of our products, services, processes, people, and most importantly, the quality of our customer's experience.

## Quality Policy

Marco is committed to providing superior quality in the design, manufacturing, distribution, rental, service, and repair of our products. Our ISO 9001:2008 certification extends throughout all operations in all locations. Continuous improvement of our processes and supply chain Integration comprise the core of our business strategy for delivering exceptional quality and value in all Marco products and services.

## Management Philosophy

We are a company dedicated to the success of every customer and associate. We discuss, debate, challenge, measure, and test our ideas. We will be boundless and limitless in our passion to improve. Through sound leadership and dedicated associates, we will ensure a long term, profitable future for Marco, our associates, customers, and suppliers.

# TABLE OF CONTENTS

<b>Company Profile</b> .....	<b>2</b>
<b>Table of Contents</b> .....	<b>3</b>
<b>Bullard® EDP 16TE Free-Air® Pump</b> .....	<b>4-5</b>
Part Numbers .....	4
Part Numbers & Schematics .....	5
Optional Accessories .....	6
<b>Maintenance Notes</b> .....	<b>7</b>

# PART NUMBERS & SCHEMATICS GUIDE

<b>BULLARD® EDP 16HAZ FREE-AIR® PUMPS</b>				
<b>Part Numbers</b>	<b>Motor Type</b>	<b>Number of Outlets</b>	<b>CFM</b>	<b>Hazardous Duty</b>
<b>10BEDP16HAZ</b>	Electric-Driven	2	16	Yes

*\*Actual number of respirators that may be connected to these products is dependent on the inlet pressure to the panel, and the airflow and pressure requirements of the respirator.*

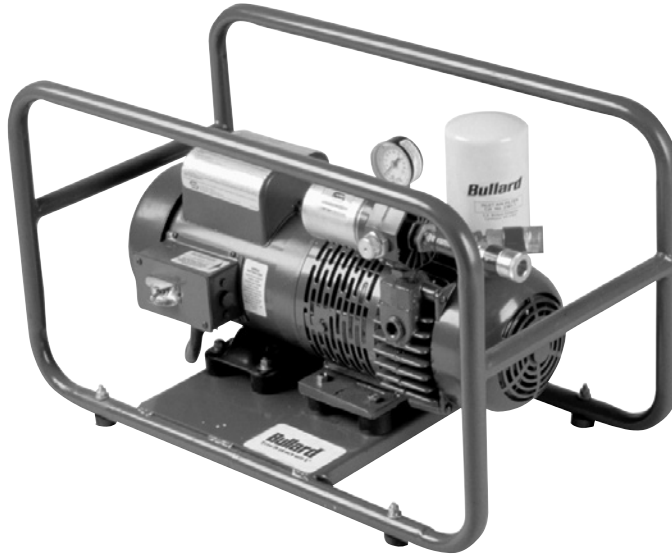





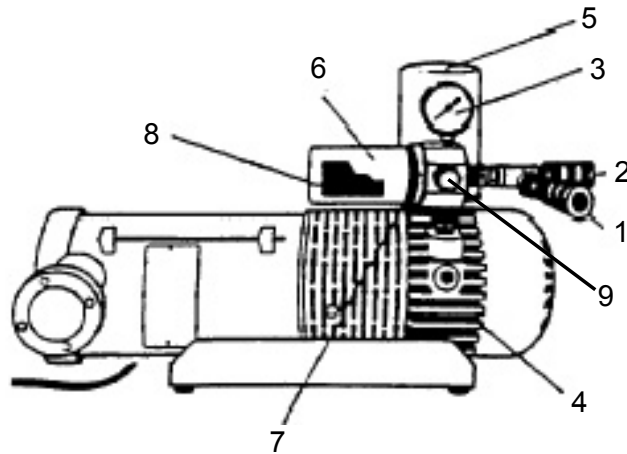





## PART NUMBERS & SCHEMATICS GUIDE

Figure 1: Bullard® EDP 16HAZ Free-Air® Pump



Item #	Part #	Description
<b>Fig. 1</b>		
—	<b>10BEDP16HAZ</b>	<b>Bullard® EDP 16HAZ Free-Air® Pump – Complete</b>
1	10BS16191	1/2" Industrial Interchange Quick-Disconnect Shut-Off With 3/8" NPT Pipe Thread
2	10BS16481	1/2" Industrial Interchange Quick-Disconnect Shut-Off With 3/8" NPT Pipe Thread
3	10BS19683	Pressure Gauge, Outlet Air Pressure, 0 – 30 psi
4	10B15922	Service Kit <i>(Includes Item #'s: 5, 8, and four Carbon Vanes)</i>
5	10B23611	Inlet Filter
6	10B244852	Outlet Filter Jar
7	10B263552	Outlet Filter Assembly O-Ring
8	10BS17101	Carbofine Outlet Filter Cartridge
9	10BEDP10PRV	Pressure Adjustment Knob
—	106M492	Part Numbers and Schematics Guide - Bullard® EDP 16HAZ Free-Air® Pump
—	109V492	Operator's Manual - Bullard® EDP 16HAZ Free-Air® Pump

## OPTIONAL ACCESSORIES

		<b>EDP 16HAZ FREE-AIR® PUMP ACCESSORIES</b>
<b>Part Numbers</b>	<b>Description</b>	
	<b>10BV22</b>	Quick-Disconnect Adapter, Converts Pumps Quick-Disconnect Coupler To Double 3/8" Female NPT
	<b>10BV23</b>	Quick-Disconnect Adapter, Converts Pumps Quick-Disconnect Coupler To Single 3/8" Female NPT
	<b>10BF35B</b>	1/2" Industrial Interchange Quick-Disconnect Constant Flow Coupling with Threaded Hose Connector and 10B4612 Belt
	<b>10BV24</b>	Quick-Disconnect Splitter/Adapter, Converts Pumps Quick-Disconnect Coupler To Double 1/2" Industrial Interchange Female Couplers ( <i>one flow-through, one shut-off</i> )
	<b>10BINLINE16</b>	Inline Filter Assembly for Remote Re-locating of Outlet
	<b>10BS16483</b>	1/2" Industrial Interchange Quick-Disconnect Coupling with 3/4" NPT Pipe Thread
	<b>10B263552</b>	Outlet Filter O-ring
	<b>10BV50EX</b>	Remote Extension Hose – 50 Ft.
	<b>10BV50IN</b>	Remote Inlet Air Hose And Fittings – 50 Ft.
	<b>10BV2050ST</b>	1/2" I.D. Breathing Line with 1/2" Male And Female Quick-Disconnect Coupling – 50 Ft.
	<b>10BV20100ST</b>	1/2" I.D. Breathing Line with 1/2" Male And Female Quick-Disconnect Coupling – 100 Ft.



## GLOBAL HEADQUARTERS

- 3425 East Locust Street  
Davenport, IA 52803

ph: 800.BLAST.IT (800.252.7848)

ph: 563.324.2519

fax: 563.324.6258

## GULF STATES HEADQUARTERS

- 701 East Boulevard  
Deer Park, TX 77536

ph: 800.BLAST.IT (800.252.7848)

ph: 281.930.0905

fax: 281.542.0736

## REGIONAL BRANCH OFFICES

- **Iowa**  
Davenport
- **Louisiana**  
Gonzales  
Lafayette
- **Ohio**  
Youngstown
- **Texas**  
Beaumont  
Corpus Christi  
Deer Park



ABRASIVES

BLASTING

COATING

DUST COLLECTORS

ENGINEERED SYSTEMS

RENTAL

SAFETY

SERVICE & REPAIR

VACUUMS

## 40+ NATIONWIDE SHIPPING LOCATIONS



★ Marco Regional Branch Offices  
and Shipping Locations

● Direct Shipping Locations

## CONTACT MARCO

**800.BLAST.IT**

**(800.252.7848)**

**563.324.2519**

**FAX: 563.324.6258**

**WWW.MARCO.US**

**SALES@MARCO.US**