

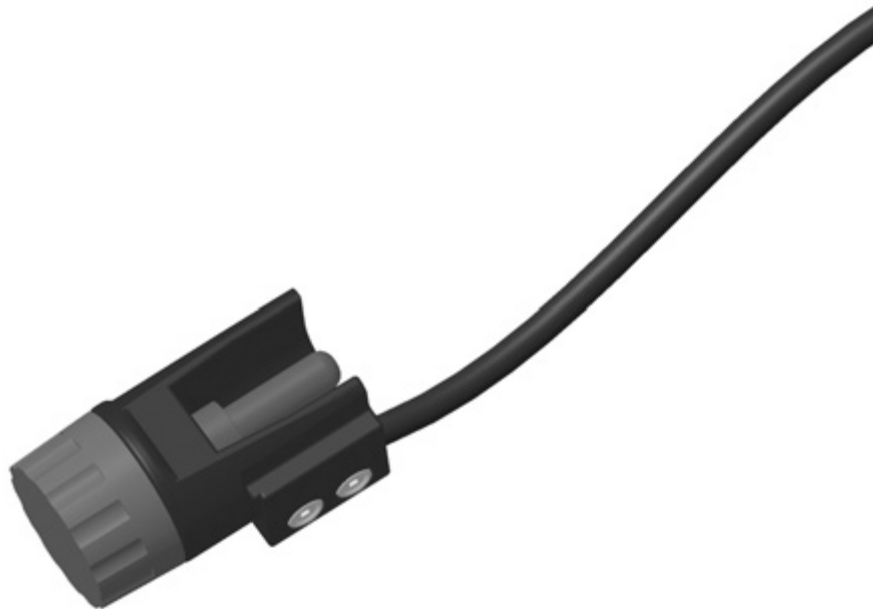

# BLASTMASTER® 157E REMOTE CONTROL SWITCH



**BUILT** MARCO  
TOUGH  
MARCO MANUFACTURED

**PART NUMBERS AND SCHEMATICS GUIDE**

## Company Profile

Since 1944, Marco has developed a strong tradition of providing innovative and reliable products and services to the surface preparation and protective coatings industries. We are the world's premier provider of Abrasives, Blasting, Coating, Dust Collectors, Engineered Systems, Rental, Safety, Service, Repair, & Modernization, and Vacuums.

Through innovative designs and a total commitment to quality, Marco manufactures products that increase production rates, create a safer workplace, and reduce maintenance costs. Marco's industry experience, manufacturing capabilities, legendary customer service, product availability, logistics services, and technology leadership is your assurance that we deliver high quality products and services, providing the best value to you, our customer.

## The Marco Difference

- **Industry Experience** – With Marco on your team, you have access to expertise which can only come from decades of industry leadership. We have organized our engineering department, production specialists, customer operations, and safety support into a "Center of Competence." As a Marco customer, you have access to hundreds of years of cumulative experience related to your operations.
- **Manufacturing Excellence** – Marco is a manufacturer of equipment for the Surface Preparation and Protective Coatings industries. Marco's engineers benchmark the industry to ensure that we design and manufacture superior products that set the "Gold Standard" for performance, safety, and quality.
- **Legendary Customer Service** – Marco's legendary customer service team is staffed by friendly, highly-trained individuals who are focused on providing the highest level of product support, order accuracy, and customer satisfaction.
- **Product Availability** – We stock over 10,000 SKU's and have more than 45 shipping locations to serve North American and International markets for all major brands of blasting and coating equipment. As the largest provider of surface preparation and protective coatings equipment in the world, our inventory levels and product availability are unmatched.
- **Logistics Services** – Marco's in-house logistics team is dedicated to moving your shipment anywhere in the world. We move more than 14,000 truckloads every year, allowing you to save on freight costs by leveraging our buying power. Lower your process costs with a single invoice, which includes product and freight.
- **Technology Leadership** – Our website provides: Operator's Manuals, Part Numbers and Schematics Guides, SDS information, and Features & Specifications Guides, providing access to information 24/7. Our Extranet application allows you to receive quotes and place orders online. Our Intranet maintains a complete record of your purchase history to assist with ongoing support of your existing equipment and future purchasing decisions.

## Vision Statement

Marco is the world's premier provider of Abrasives, Blasting, Coating, Dust Collectors, Engineered Systems, Rental, Safety, Service, Repair, & Modernization, and Vacuums.

## Mission Statement

Marco provides strong leadership and innovation to the surface preparation and protective coatings industries. We dedicate our efforts to the continuous improvement of our products, services, processes, people, and most importantly, the quality of our customer's experience.

## Quality Statement

Marco is committed to providing superior quality in the design, manufacturing, distribution, rental, service, and repair of our products. Continuous improvement of our processes and supply chain Integration comprise the core of our business strategy for delivering exceptional quality and value in all Marco products and services.

## Management Philosophy

We are a company dedicated to the success of every customer and associate. We discuss, debate, challenge, measure, and test our ideas. We will be boundless and limitless in our passion to improve. Through sound leadership and dedicated associates, we will ensure a long term, profitable future for Marco, our associates, customers, and suppliers.

# TABLE OF CONTENTS

<b>Company Profile</b> .....	1
<b>Table of Contents</b> .....	2
<b>Blastmaster® 157E</b>	
<b>Remote Control Switch</b> .....	3-4
Part Numbers & Schematics .....	3-4
<b>Optional Accessories</b> .....	5-6
Electrical Cord .....	5
Electric Control Lines with Plugs .....	5
Electric Control Line Plugs .....	6

## PART NUMBERS AND SCHEMATICS GUIDE

<b>BLASTMASTER® 157E REMOTE CONTROL SWITCH</b>				
<b>Part Numbers</b>	<b>Material of Construction</b>	<b>Replaceable Switch</b>	<b>Hose Clamp</b>	<b>16/3 Electrical Cord Length</b>
1015700	Urethane	X	X	4 Ft.

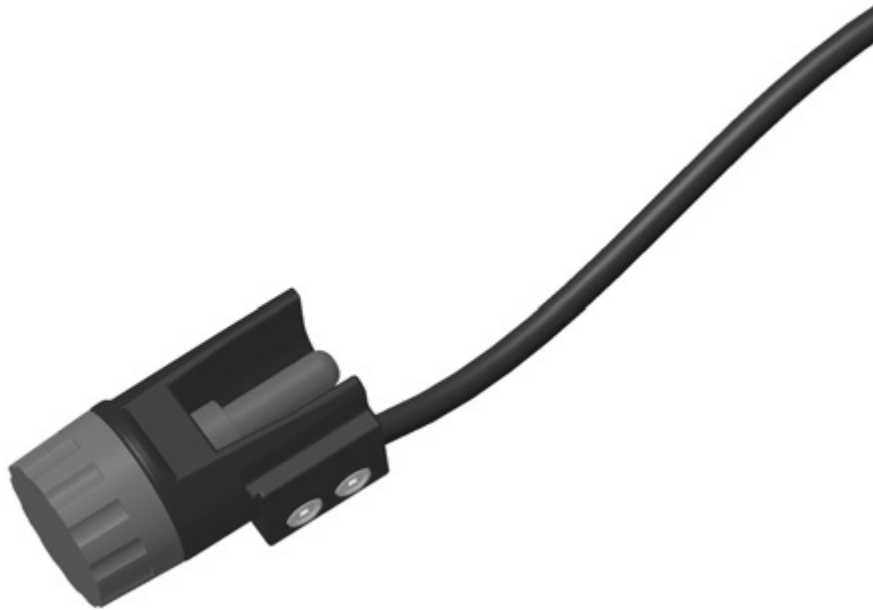

## PART NUMBERS AND SCHEMATICS GUIDE

Figure 1: Blastmaster® 157E Remote Control Switch

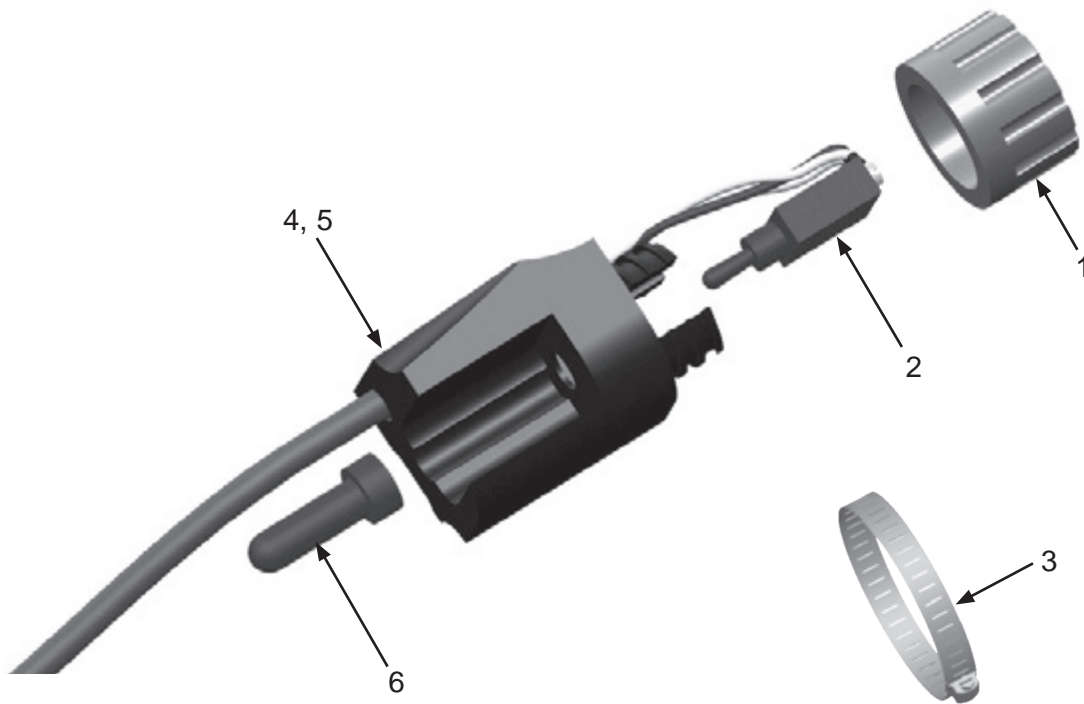

Item #	Part #	Description
<b>Fig. 1</b>		
—	<b>1015700</b>	<b>Blastmaster® 157E Remote Control Switch with 4 Feet of Power Cord – Complete</b>
1	1015603 1015601	Cap Cap (For units purchased prior to May 2020)
2	1015705	Repair Kit (Includes Item #6 and Switch with 4 Feet of 16/3 Electrical Cord)
3	1015503	Hose Clamp
4	10106524	#8 Countersunk Washer (Quantity of Two)
5	10106525	#8 x 1" Large Flat-Head Drive Screw (Quantity of Two)
6	1015501	Toggle Boot
—	1091045	Hazard Identification Tag
—	106M140	Part Numbers and Schematics Guide – Blastmaster® 157E Remote Control Switch
—	1090140	Operator's Manual – Blastmaster® 157E Remote Control Switch



## OPTIONAL ACCESSORIES





**Part Numbers**

ELECTRICAL CORD				
	Gauge	# of Wires	Type	Length
1015701	16	3		Per Foot
1015550	14	3	SEOOW	Per Foot
1015571	12	3	SJEOOW	Per Foot
1015581	10	3	SEOOW	Per Foot
1015591	8	3	SEOOW	Per Foot
1015595	6	3	SEOOW	Per Foot

### ELECTRIC CONTROL LINES WITH PLUGS

	Part Numbers	Gauge	# of Wires	3-Prong Male Twist-Lock Plug	3-Prong Female Twist-Lock Plug	Length
	1015748	16	3	1015555	1015556	13 Feet
	1015745	16	3	1015555	1015556	50 Feet
	1015747	16	3	1015555	1015556	110 Feet

# OPTIONAL ACCESSORIES

		<b>ELECTRIC CONTROL LINE PLUGS</b>	
<b>Part Numbers</b>		<b>Prong Style</b>	<b>Plug Style</b>
	<b>1015555</b>	3-Prong Male	Twist-Lock
	<b>1015556</b>	3-Prong Female	Twist-Lock

## CONTACT CENTER

- 3425 East Locust Street  
Davenport, IA 52803

ph: 800.BLAST.IT (800.252.7848)  
ph: 563.324.2519  
fax: 563.324.6258

## REGIONAL BRANCH OFFICES

- Iowa  
Davenport
- Louisiana  
Gonzales  
Lafayette
- Ohio  
Youngstown
- Texas  
Beaumont  
Corpus Christi  
Deer Park

## 40+ NATIONWIDE SHIPPING LOCATIONS



★ Marco Regional Branch Offices  
and Shipping Locations

● Direct Shipping Locations



ABRASIVES

BLASTING

COATING

DUST COLLECTION

RENTAL & SERVICE

SAFETY

VACUUMS

## CONTACT MARCO

800.BLAST.IT  
(800.252.7848)  
563.324.2519  
FAX: 563.324.6258

WWW.MARCO.US  
SALES@MARCO.US