

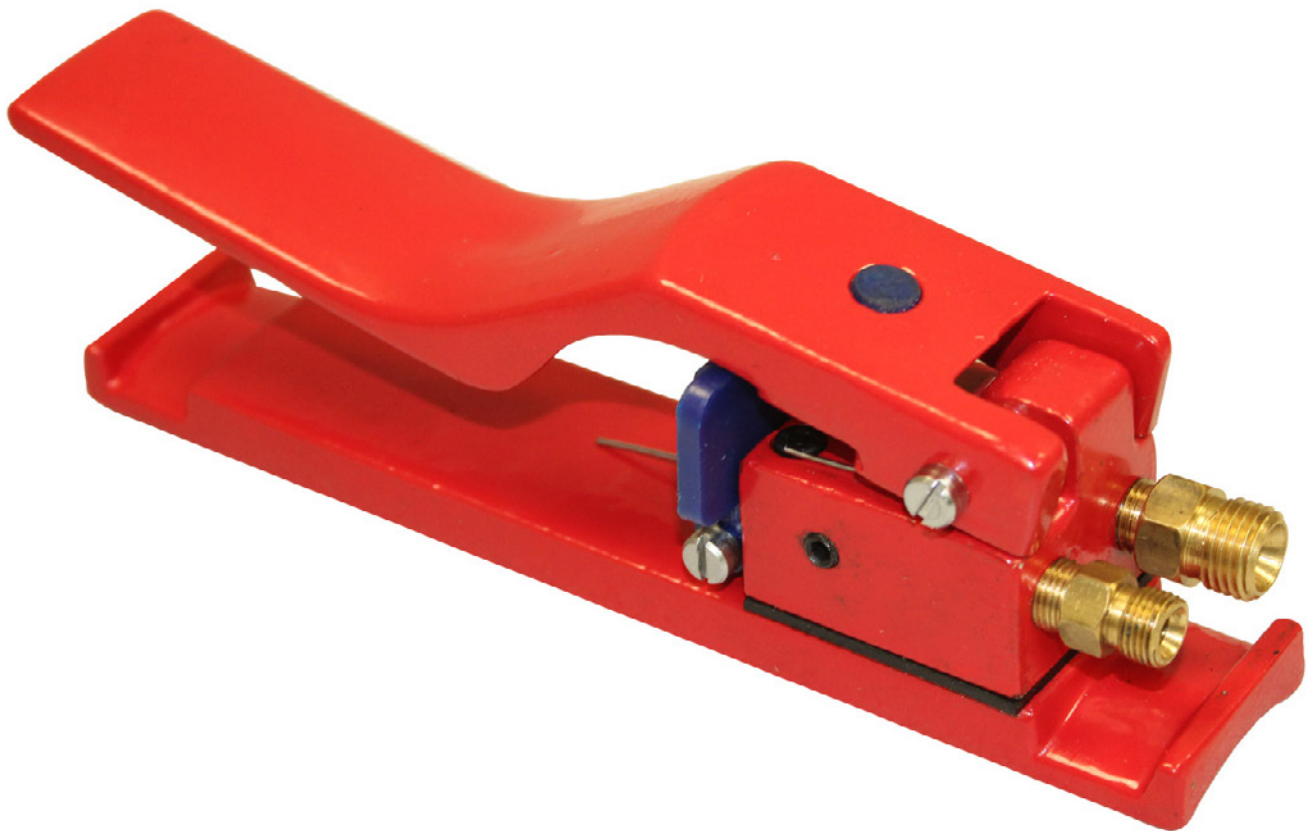

**BLASTMASTER® 152P  
REMOTE CONTROL SWITCH**



**BUILT MARCO  
TOUGH**  
MARCO MANUFACTURED

**PART NUMBERS AND SCHEMATICS GUIDE**

## Company Profile

Since 1944, Marco has developed a strong tradition of providing innovative and reliable products and services to the surface preparation and protective coatings industries. We are the world's premier provider of Abrasives, Blasting Equipment, Coating Equipment, Engineered Systems, Rental Equipment, Safety Equipment, Service, and Repair.

Through innovative designs and a total commitment to quality, Marco manufactures products that increase production rates, create a safer workplace, and reduce maintenance costs. Marco's industry experience, manufacturing capabilities, legendary customer service, product availability, logistics services, and technology leadership is your assurance that we deliver high quality products and services, providing the best value to you, our customer.

## The Marco Difference

- **Industry Experience** – With Marco on your team, you have access to expertise which can only come from decades of industry leadership. We have organized our engineering department, production specialists, customer operations, and safety support into a "Center of Competence." As a Marco customer, you have access to hundreds of years of cumulative experience related to your operations.
- **Manufacturing Excellence** – Marco is a U.S. based, ISO 9001:2008 certified manufacturer of equipment for the Surface Preparation and Protective Coatings industries. Marco's engineers benchmark the industry to ensure that we design and manufacture superior products that set the "Gold Standard" for performance, safety, and quality.
- **Legendary Customer Service** – Marco's legendary customer service team is staffed by friendly, highly-trained individuals who are focused on providing the highest level of product support, order accuracy, and customer satisfaction.
- **Product Availability** – We stock over 10,000 SKU's and have over 45 shipping locations to serve North American and International markets for all major brands of blasting and painting equipment. As the largest provider of surface preparation and protective coatings equipment in the world, our inventory levels and product availability are unmatched.
- **Logistics Services** – Marco's in-house logistics team is dedicated to moving your shipment anywhere in the world. We move over 14,000 truckloads every year, allowing you to save on freight costs by leveraging our buying power. Lower your process costs with a single invoice, which includes product and freight.
- **Technology Leadership** – Our website provides: Operator's Manuals, Part Numbers and Schematics Guides, MSDS information, and Features and Specifications Guides, providing access to information 24/7. Our Extranet application allows you to receive quotes and place orders online. Our Intranet maintains a complete record of your purchase history to assist with ongoing support of your existing equipment and future purchasing decisions.

## Vision Statement

Marco is the world's premier provider of Abrasives, Blasting Equipment, Coating Equipment, Engineered Systems, Rental Equipment, Safety Equipment, Service, and Repair.

## Mission Statement

Marco provides strong leadership and innovation to the surface preparation and protective coatings industries. We dedicate our efforts to the continuous improvement of our products, services, processes, people, and most importantly, the quality of our customer's experience.

## Quality Statement

Marco is committed to providing superior quality in the design, manufacturing, distribution, rental, service, and repair of our products. Our ISO 9001:2008 certification extends throughout all operations in all locations. Continuous improvement of our processes and supply chain Integration comprise the core of our business strategy for delivering exceptional quality and value in all Marco products and services.

## Management Philosophy

We are a company dedicated to the success of every customer and associate. We discuss, debate, challenge, measure, and test our ideas. We will be boundless and limitless in our passion to improve. Through sound leadership and dedicated associates, we will ensure a long term, profitable future for Marco, our associates, customers, and suppliers.

# DEFINITION OF TERMS

<b>Company Profile</b> .....	<b>1</b>
<b>Table of Contents</b> .....	<b>2</b>
<b>Blastmaster® 152P</b>	
<b>Remote Control Switch</b> .....	<b>3-8</b>
Part Number .....	3-4
Part Numbers & Schematics .....	5-6
Blastmaster® 152P Remote Control Switch .....	5-6
Optional Accessories .....	7-8
<b>Maintenance Notes.</b> .....	<b>9-10</b>

# PART NUMBER

<b>BLASTMASTER® 152P REMOTE CONTROL SWITCHES</b>			
<b>Part Numbers</b>	<b>Body Material</b>	<b>Repairable</b>	<b>Pneumatic Control Line Fittings</b>
1015200	Aluminum	Yes	1/4" & 1/8" NPT

**BLASTMASTER® 152P REMOTE CONTROL SWITCH**

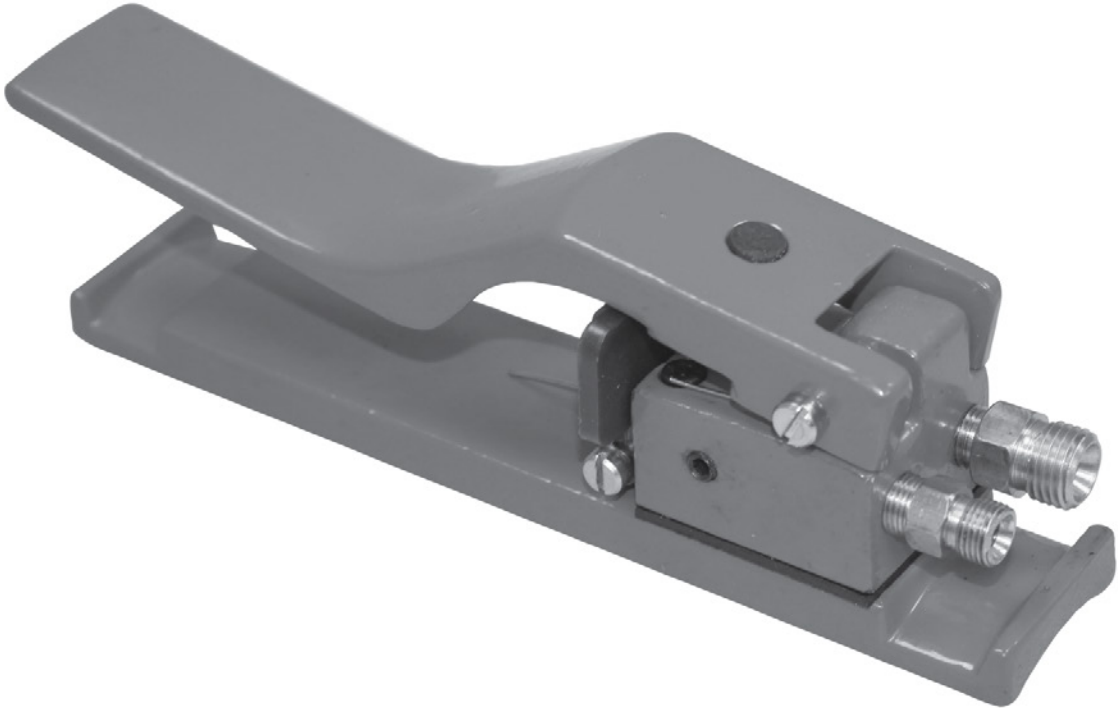

## PART NUMBERS & SCHEMATICS

Item #	Part #	Description
<b>Fig. 1</b>		
—	<b>1015200</b>	<b>Blastmaster® 152P Remote Control Switch – Complete</b>
1	10102171	Handle
2	10102181	Button Bumper
3	10102175	Air Valve Stem
4	10102178	M4 x 30 Socket Head Cap Screw <i>(Three Required)</i>
5	10102184	M4 Lock Nut <i>(Two Required)</i>
6	10102179	Spring
7	10102182	M6 Set Screw
8	10102172	Manifold <i>(Includes Item #'s: 3, 7, 11, 12, 13 and 20)</i>
9	10102187	1/8" NPSL x 1/8" NPT Control Line Fitting
10	10102186	1/4" NPSL x 1/8" NPT Control Line Fitting
11	10102176	Air Valve Packing
12	10102183	Valve Stem Spring
13	10102173	Manifold Gasket
14	1015015	Nylon Zip Tie - White <i>(Two Required)</i>
15	10102170	Base Plate
16	10102180	M4 x 48.9 Shoulder Screw
17	10102241	Safety Tab Spring
18	10102174	Safety Tab
19	10102185	M4 x 42 Shoulder Screw
20	10102177	O-Ring
—	10102169	Blastmaster® 152P Remote Control Switch Repair Kit <i>(Includes Item #'s: 3, 7, 8, 11, 12, and 20; and two each of 14)</i>
—	105M068	Features and Specifications Guide – Blastmaster® 152P Remote Control Switch
—	106M068	Part Numbers and Schematics Guide – Blastmaster® 152P Remote Control Switch
—	1090068	Operator's Manual – Blastmaster® 152P Remote Control Switch
—	1091045	Hazard Identification Tag



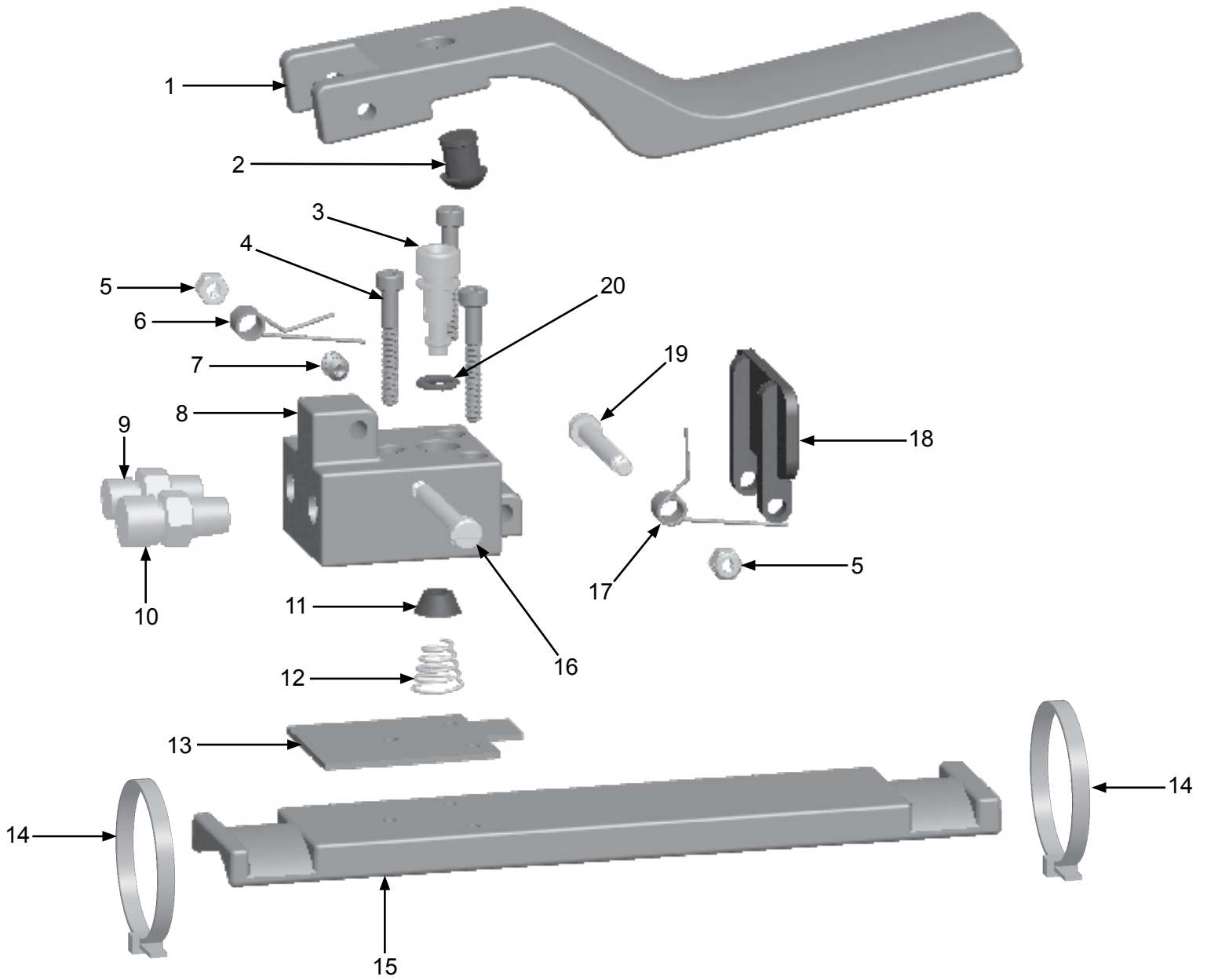

# PART NUMBERS & SCHEMATICS

Figure 1: Blastmaster® 152P Remote Control Switch











# OPTIONAL ACCESSORIES



## PNEUMATIC CONTROL LINE

	<b>Part Numbers</b>	<b>Hose Length</b>	<b>Working Pressure</b>	<b>Hose I.D.</b>	<b>Hose O.D.</b>	<b>1017012</b>	<b>1017013</b>	<b>1017014</b>	<b>1017015</b>
	<b>1016002</b>	7 Feet	200 psi	3/16"	7/16"	X	X	X	X
	<b>1016000</b>	55 Feet	200 psi	3/16"	7/16"	X	X	X	X
	<b>1016001</b>	110 Feet	200 psi	3/16"	7/16"	X	X	X	X
	<b>10TLBK</b>	Per Foot	200 psi	3/16"	7/16"				



## OPTIONAL ACCESSORIES

		PNEUMATIC CONTROL LINE FITTINGS		
	<b>Part Numbers</b>	<b>Description</b>	<b>Hose I.D.</b>	<b>Hose O.D.</b>
	1017012	1/8" Female Nut & Barb	3/16"	7/16"
	1017013	1/4" Female Nut & Barb	3/16"	7/16"
	1017014	1/8" Male Threaded Barb	3/16"	7/16"
	1017015	1/4" Male Threaded Barb	3/16"	7/16"
	1017010	Hose Splicer	3/16"	7/16"
	1017017	Hose Ferrule	3/16"	7/16"
	1017011	Oetiker® Clamp	3/16"	7/16"
	1017018	1/8" x 1/8" Hex Nipple	3/16"	7/16"
	1017019	1/4" x 1/4" Hex Nipple	3/16"	7/16"

	<b>Part Numbers</b>	PNEUMATIC CONTROL LINE FITTINGS ACCESSORIES	
	10DX855A	Ferrule Crimping Tool	
	10DX1098	Oetiker® Clamp Tool	

Oetiker® is a registered trademark of Dixon Valve & Coupling Co.

# MAINTENANCE NOTES

DATE	TYPE OF SERVICE	PART NUMBER



## GLOBAL HEADQUARTERS

- 3425 East Locust Street  
Davenport, IA 52803

ph: 800.BLAST.IT (800.252.7848)

ph: 563.324.2519

fax: 563.324.6258

## GULF STATES HEADQUARTERS

- 701 East Boulevard  
Deer Park, TX 77536

ph: 800.BLAST.IT (800.252.7848)

ph: 281.930.0905

fax: 281.542.0736

## REGIONAL BRANCH OFFICES

- **Iowa**  
Davenport
- **Louisiana**  
Gonzales  
Lafayette
- **Ohio**  
Youngstown
- **Texas**  
Beaumont  
Corpus Christi  
Deer Park



ABRASIVES

BLASTING

COATING

DUST COLLECTOR

ENGINEERED SYSTEMS

RENTAL

SAFETY

SERVICE & REPAIR

VACUUMS

## 40+ NATIONWIDE SHIPPING LOCATIONS



★ Marco Regional Branch Offices  
and Shipping Locations

● Direct Shipping Locations

## CONTACT MARCO

**800.BLAST.IT**

**(800.252.7848)**

**563.324.2519**

**FAX: 563.324.6258**

**WWW.MARCO.US**

**SALES@MARCO.US**