



## BINKS® 7E2 AIR SPRAY GUN



PART NUMBERS AND SCHEMATICS GUIDE

## Company Profile

Since 1944, Marco has developed a strong tradition of providing innovative and reliable products and services to the surface preparation and protective coatings industries. We are the world's premier provider of Abrasives, Blasting Equipment, Coating Equipment, Engineered Systems, Rental Equipment, Safety Equipment, Service, and Repair.

Through innovative designs and a total commitment to quality, Marco manufactures products that increase production rates, create a safer workplace, and reduce maintenance costs. Marco's industry experience, manufacturing capabilities, legendary customer service, product availability, logistics services, and technology leadership is your assurance that we deliver high quality products and services, providing the best value to you, our customer.

## The Marco Difference

- **Industry Experience** – With Marco on your team, you have access to expertise which can only come from decades of industry leadership. We have organized our engineering department, production specialists, customer operations, and safety support into a “Center of Competence.” As a Marco customer, you have access to hundreds of years of cumulative experience related to your operations.
- **Manufacturing Excellence** – Marco is a U.S. based, ISO 9001:2008 certified manufacturer of equipment for the Surface Preparation and Protective Coatings industries. Marco's engineers benchmark the industry to ensure that we design and manufacture superior products that set the “Gold Standard” for performance, safety, and quality.
- **Legendary Customer Service** – Marco's legendary customer service team is staffed by friendly, highly-trained individuals who are focused on providing the highest level of product support, order accuracy, and customer satisfaction.
- **Product Availability** – We stock over 10,000 SKU's and have over 45 shipping locations to serve North American and International markets for all major brands of blasting and painting equipment. As the largest provider of surface preparation and protective coatings equipment in the world, our inventory levels and product availability are unmatched.
- **Logistics Services** – Marco's in-house logistics team is dedicated to moving your shipment anywhere in the world. We move over 14,000 truckloads every year, allowing you to save on freight costs by leveraging our buying power. Lower your process costs with a single invoice, which includes product and freight.
- **Technology Leadership** – Our website provides: Operator's Manuals, Part Numbers and Schematics Guides, MSDS information, and Features and Specifications Guides, providing access to information 24/7. Our Extranet application allows you to receive quotes and place orders online. Our Intranet maintains a complete record of your purchase history to assist with ongoing support of your existing equipment and future purchasing decisions.

## Vision Statement

Marco is the world's premier provider of Abrasives, Blasting Equipment, Coating Equipment, Engineered Systems, Rental Equipment, Safety Equipment, Service, and Repair.

## Mission Statement

Marco provides strong leadership and innovation to the surface preparation and protective coatings industries. We dedicate our efforts to the continuous improvement of our products, services, processes, people, and most importantly, the quality of our customer's experience.

## Quality Statement

Marco is committed to providing superior quality in the design, manufacturing, distribution, rental, service, and repair of our products. Our ISO 9001:2008 certification extends throughout all operations in all locations. Continuous improvement of our processes and supply chain Integration comprise the core of our business strategy for delivering exceptional quality and value in all Marco products and services.

## Management Philosophy

We are a company dedicated to the success of every customer and associate. We discuss, debate, challenge, measure, and test our ideas. We will be boundless and limitless in our passion to improve. Through sound leadership and dedicated associates, we will ensure a long term, profitable future for Marco, our associates, customers, and suppliers.

# TABLE OF CONTENTS

<b>Company Profile</b> .....	<b>2</b>
<b>Table of Contents</b> .....	<b>3</b>
<b>Binks® 7E2 Air Spray Gun</b> .....	<b>4-7</b>
Fluid Tips and Needles.....	4
Air Caps.....	5
Retainer Rings.....	5
Part Numbers and Schematics.....	6-7

## PART NUMBERS AND SCHEMATICS GUIDE





**Part Numbers**

<b>BINKS® 7E2 AIR SPRAY GUN</b>			
<b>Part Numbers</b>	<b>Air Cap</b>	<b>Fluid Tip</b>	<b>Type</b>
20BK610229007	1/4	44SS	Pressure
20BK610236007	1/4	45SS	Pressure
20BK610236017	3/8	45SS	Pressure
20BK610236023	3/8F	45SS	Pressure
20BK610235259	391	46SS	Pressure

### FLUID TIPS AND NEEDLES

<b>Part Numbers</b>	<b>Fluid Tips</b>	<b>Orifice Size</b>	<b>Fluid Needle (Sold Separately)</b>
 20BK454601	44SS	4.75 mm (0.187 in)	20BK541219
20BK454501	45SS	6.35 mm (0.250 in)	20BK541219
20BK454701	47SS	7.92 mm (0.312 in)	20BK541219
20BK454401	44SS	9.52 mm (0.375 in)	20BK541219

# PART NUMBERS AND SCHEMATICS GUIDE

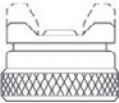
		AIR CAPS	
Part Numbers		Cap Number	Retaining Ring Included
	20BK464002	1/4	
	20BK464004	3/8	
	20BK464006	3/8F	
	20BK462190	190	
	20BK462191	191	
	20BK462390	390SS	
	20BK462391	391SS	
	20BK464011	1/4E	X

		RETAINING RING AND BASE
Part Number		Description
	20BK54864	Binks® 7E2 Air Spray Gun Retaining Ring

## PART NUMBERS AND SCHEMATICS GUIDE

### Binks® 7E2 Air Spray Gun

Item#	Part#	Description
<b>Fig. 1</b>		
1	—	Air Cap <i>(see chart on page 8)</i>
2	—	Fluid Tip <i>(see chart on page 8)</i>
3	20BK201237	Set Screw 1/4-20 X 1/4
4	20BK202002	Wrench, Allen 1/8" Hex
5	20BK54710	Screw
6	20BK54714	Plug
7	20BK54723	Gasket Fluid Control
8	20BK54725	Screw Spring Retainer
9	20BK54726	Body Fluid Control
10	20BK54744	Air Valve Stem
11	20BK54747	Air Valve Packing
12	20BK54749	Air Valve Gasket
13	20BK54750	Air Valve Spring
14	20BK54741	Air Valve Body
15	20BK54753	Trigger Screw
16	20BK54760	Trigger Stud
17	20BK54788	Air Connection
18	20BK54806	Cap
19	20BK54839	Fluid Control Spring
20	20BK54864	Retainer Ring
21	20BK541091	Four Finger Trigger
22	20BK541204	Gun Body
23	20BK511205	Needle Valve Packing
24	20BK541210	Needle Collar
25	20BK511213	Ring
26	20BK541219	Needle
27	20BK541220	Needle Pin
28	20BK541221	Fluid Control Housing
29	20BK541223	Fluid Control Screw Assembly <i>(Includes Item #'s: 8, 9, 19, 25)</i>
30	20BK541239	Gun Head
31	20BK541244	Packing Nut
32	20BK541245	Gun Body Assembly <i>(Includes Item #'s: 5, 22, 30)</i>
33	20BK541246	Fluid Nozzle Gasket
34	20BK541340	Air Valve Packing Nut
35	20BK541341	Air Valve Assembly <i>(Includes Item #'s: 10, 11, 14, 34)</i>
36	20BK543264	Stainless Steel Needle <i>(Optional)</i>
37	20BK82221	Cleaning Brush <i>(Not Shown)</i>
—	20BK6224	Repair Kit - Binks® 7E2 Air Spray Gun <i>(Includes Item #'s: 11, 12, 13, 23, 33)</i>
—	206M535	Part Numbers and Schematics Guide - Binks® 7E2 Air Spray Gun
—	209V535	Operator's Manual - Binks® 7E2 Air Spray Gun

# PART NUMBERS AND SCHEMATICS GUIDE

Figure 1: Binks® 7E2 Air Spray Gun

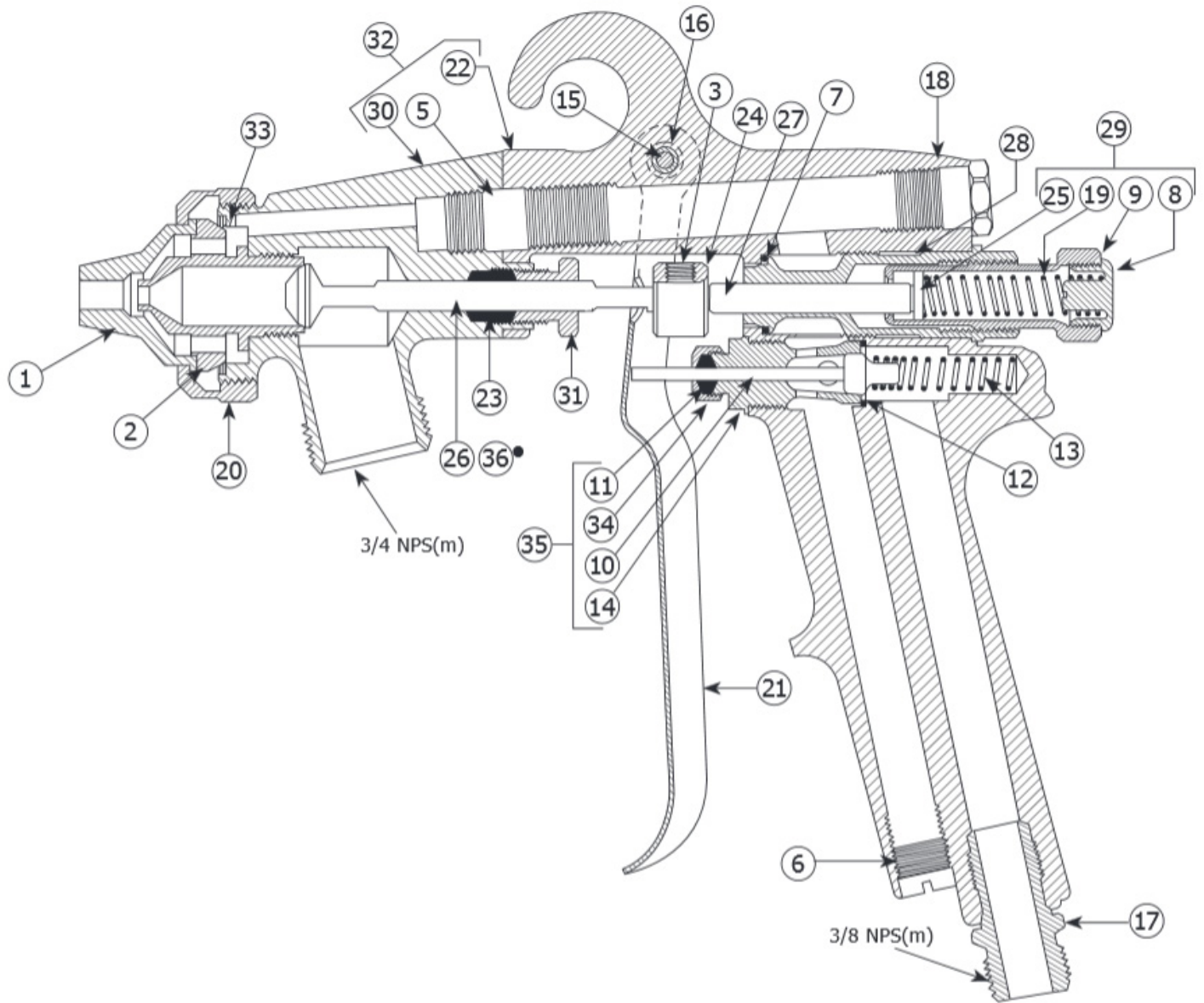

## GLOBAL HEADQUARTERS

- 3425 East Locust Street  
Davenport, IA 52803

ph: 800.BLAST.IT (800.252.7848)

ph: 563.324.2519

fax: 563.324.6258

## GULF STATES HEADQUARTERS

- 701 East Boulevard  
Deer Park, TX 77536

ph: 800.BLAST.IT (800.252.7848)

ph: 281.930.0905

fax: 281.542.0736

## REGIONAL BRANCH OFFICES

- **Iowa**  
Davenport
- **Louisiana**  
Gonzales  
Lafayette
- **Ohio**  
Youngstown
- **Texas**  
Beaumont  
Corpus Christi  
Deer Park



ABRASIVES

BLASTING

COATING

DUST COLLECTORS & VACUUMS

ENGINEERED SYSTEMS

RENTAL

SAFETY

SERVICE & REPAIR

VACUUMS

## 40+ NATIONWIDE SHIPPING LOCATIONS



★ Marco Regional Branch Offices  
and Shipping Locations

● Direct Shipping Locations

## CONTACT MARCO

**800.BLAST.IT**

**(800.252.7848)**

**563.324.2519**

**FAX: 563.324.6258**

**WWW.MARCO.US**

**SALES@MARCO.US**