



# **AXXIOM G2 & G2E REMOTE CONTROL SWITCHES**



**PART NUMBERS AND SCHEMATIC GUIDE**

## Company Profile

Allredi was formed in the early 2020, when two of the largest distributors in the blasting, coating, safety, and environmental industry, APE Companies and Marco Group International, joined forces. While the qualities both companies are known for have not changed, a lot about our business is new. New abilities. New agilities. New ways to help you win. This calls for a new name, Allredi.

This name exemplifies what we have become. It is completely oriented to the needs of our customers. To your needs. It says that when you call us for anything – products, service, expert advice, anything – you can consider it done. Or even better, Allredi done.

We are your right-now supplier. From skills to SKUs, we deliver the goods fast. So you can be more agile every minute, every day. This is who we are. This is what our new name means. Go ahead and expect excellence, because we're bringing it.

## Our Mission and Vision

To be the industry's preferred partner in surface preparation solutions through unrivaled technical expertise, customer experience, product availability, and tailored service offerings.

## The Allredi Difference

- **Industry Experience** – With Allredi on your team, you have access to expertise which can only come from decades of industry leadership. We have organized our engineering department, production specialists, customer operations, and safety support into a "Center of Competence." As an Allredi customer, you have access to hundreds of years of cumulative experience related to your operations.
- **Manufacturing Excellence** – Allredi is a U.S. based manufacturer of equipment for the Surface Preparation and Protective Coatings industries. Allredi's engineers benchmark the industry to ensure that we design and manufacture superior products that set the "Gold Standard" for performance, safety, and quality.
- **Legendary Customer Service** – Allredi's legendary customer service team is staffed by friendly, highly-trained individuals who are focused on providing the highest level of product support, order accuracy, and customer satisfaction.
- **Product Availability** – We stock over 10,000 SKU's and have over 45 shipping locations to serve North American and International markets for all major brands of blasting, coating, environmental, and safety equipment. Allredi is your right-now supplier, so you can keep your projects moving. From our foundation of strong relationships, we have built a nationwide network that puts vast inventory and ready service close to our customers. We provide advanced expertise, and we deliver the goods fast – so you can easily access the products and services you need to me more agile every minute, every day.
- **Technology Leadership** – Our website provides: Operator's Manuals, Part Numbers and Schematics Guides, SDS information, and key product features and specifications, providing access to information 24/7.

# TABLE OF CONTENTS

<b>Company Profile</b> .....	<b>2</b>
<b>Table of Contents</b> .....	<b>3</b>
<b>Axxiom G2 &amp; G2E</b>	
<b>Remote Control Switches</b> .....	<b>4-9</b>
Axxiom G2 Part Number .....	4
Axxiom G2 Pneumatic Remote Control Switch Part Numbers & Schematics .....	5
Optional Accessories .....	6-7
Axxiom G2E Part Number .....	8
Axxiom G2E Electric Remote Control Switch Part Numbers & Schematics .....	9
<b>Optional Accessories</b> .....	<b>10-11</b>

# G2 PNEUMATIC REMOTE CONTROL SWITCH

<b>G2 PNEUMATIC REMOTE CONTROL SWITCH</b>			
<b>Part Numbers</b>	<b>Body Material</b>	<b>Repairable</b>	<b>Pneumatic Control Line Fittings</b>
10S2263002	Aluminum	Yes	1/4" & 1/8" NPT





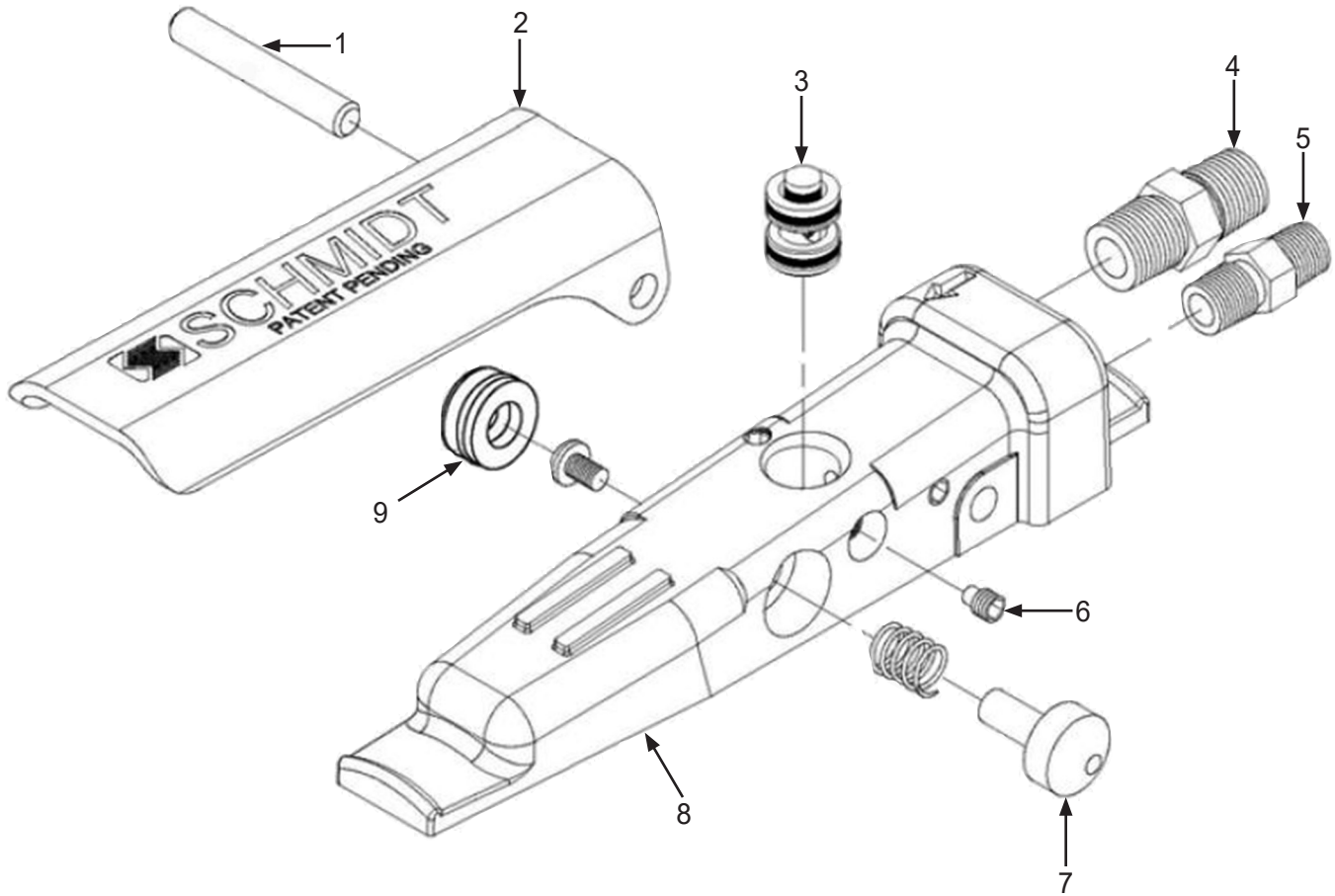

## PART NUMBERS & SCHEMATICS GUIDE

Figure 1: Axxiom G2 Pneumatic Remote Control Switch













Item #	Part #	Description
<b>Fig. 1</b>		
—	<b>10S2263002</b>	<b>Axxiom G2 Pneumatic Remote Control Switch</b>
1	10S226300204	Hinge Pin
2	10S226300201	Lever
3	10S226300203	Cartridge Assembly
4	10S303130202	1/4" x 1/4" Hex Nipple with Ball Seat
5	1017018	1/8" x 1/8" Hex Nipple with Ball Seat
6	10S226300205	Cartridge Set Screw
7	10S226300206	Button ( <i>Quantity of Four</i> )
8	10S226300202	Body
9	10S226300210	Dust Plug
—	10S226300299	G2 Service Kit ( <i>Includes Item #'s: 3, 6, spring, and button screw</i> )
—	106M446	Part Numbers and Schematics Guide – Axxiom G2 & G2E Remote Control Switches

# OPTIONAL ACCESSORIES

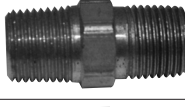
		PNEUMATIC CONTROL LINE							
		Hose Length	Working Pressure	Hose I.D.	Hose O.D.	1017012	1017013	1017014	1017015
<b>Part Numbers</b>									
	<b>1016002</b>	7 Feet	200 psi	3/16"	7/16"	X	X	X	X
	<b>1016000</b>	55 Feet	200 psi	3/16"	7/16"	X	X	X	X
	<b>1016001</b>	110 Feet	200 psi	3/16"	7/16"	X	X	X	X
	<b>10TLBK</b>	Per Foot	200 psi	3/16"	7/16"				

## OPTIONAL ACCESSORIES

		PNEUMATIC CONTROL LINE FITTINGS		
	<b>Part Numbers</b>	<b>Description</b>	<b>Hose I.D.</b>	<b>Hose O.D.</b>
	1017012	1/8" Female Nut & Barb	3/16"	7/16"
	1017013	1/4" Female Nut & Barb	3/16"	7/16"
	1017014	1/8" Male Threaded Barb	3/16"	7/16"
	1017015	1/4" Male Threaded Barb	3/16"	7/16"
	1017010	Hose Splicer	3/16"	7/16"
	1017017	Hose Ferrule	3/16"	7/16"
	1017011	Oetiker® Clamp	3/16"	7/16"
	1017018	1/8" x 1/8" Hex Nipple	3/16"	7/16"
	1017019	1/4" x 1/4" Hex Nipple	3/16"	7/16"

	<b>Part Numbers</b>	PNEUMATIC CONTROL LINE FITTINGS ACCESSORIES	
	10DX855A	Ferrule Crimping Tool	
	10DX1098	Oetiker® Clamp Tool	

Oetiker® is a registered trademark of Dixon Valve & Coupling Co.

# G2E ELECTRIC REMOTE CONTROL SWITCH

<b>G2E ELECTRIC REMOTE CONTROL SWITCH</b>				
<b>Part Numbers</b>	<b>Body Material</b>	<b>Replaceable Switch</b>	<b>Electric Control Line Length</b>	<b>Plug</b>
10S2263402	Aluminum	No	2 Feet	None









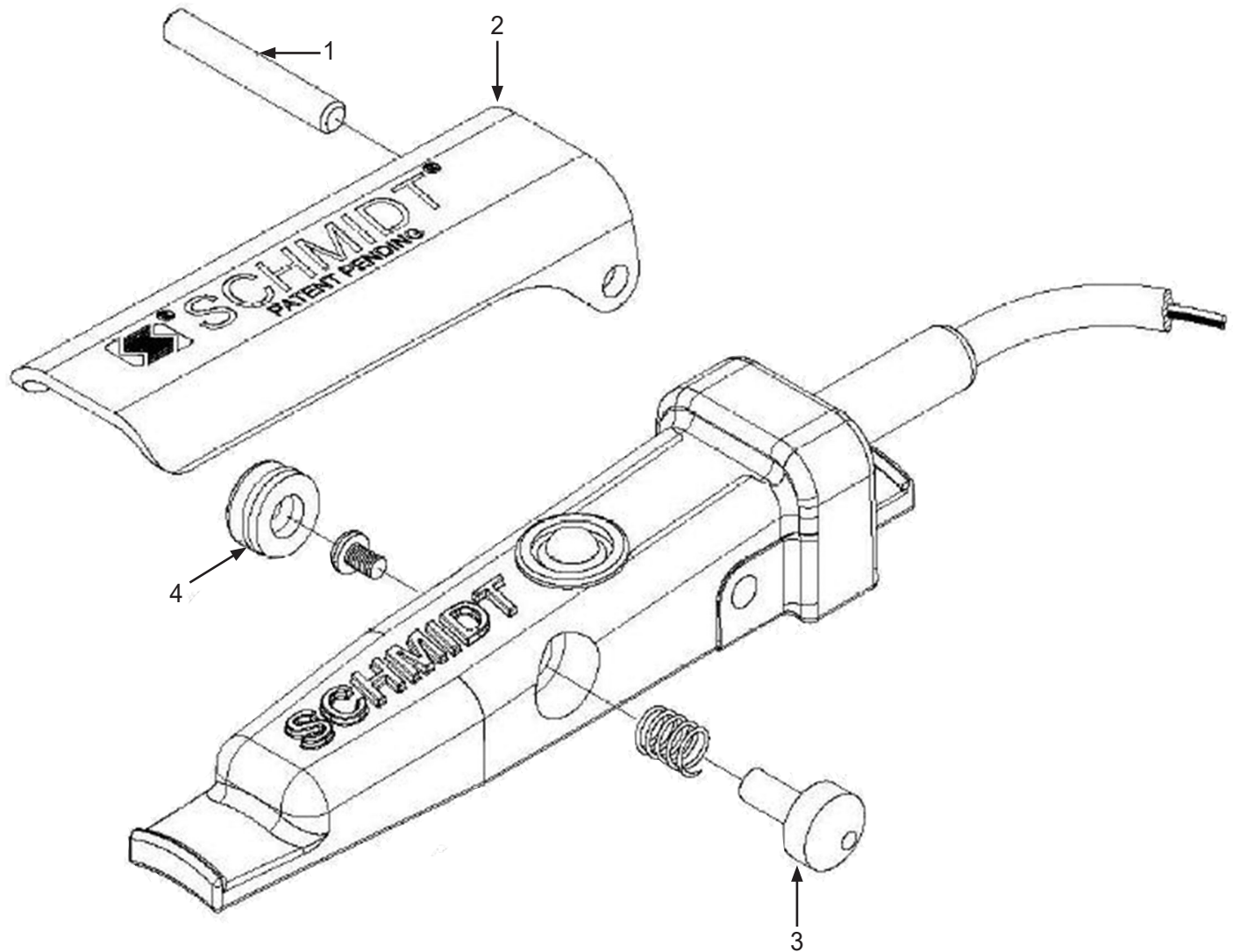



## PART NUMBERS & SCHEMATICS GUIDE

Figure 2: Axxiom G2E Electric Remote Control Switch









Item #	Part #	Description
Fig. 2		
—	<b>10S2263402</b>	<b>Axxiom G2E Electric Remote Control Switch</b>
1	10S226300204	Hinge Pin
2	10S226300201	Lever
3	10S226300206	Button ( <i>Quantity of Four</i> )
4	10S226300210	Dust Plug
—	106M446	Part Numbers and Schematics Guide – Axxiom G2 & G2E Remote Control Switches

## OPTIONAL ACCESSORIES

		ELECTRIC CONTROL LINE WITH PLUGS						
Part Numbers	Gauge	# of Wires	2-Prong Male Twist-Lock Plug	2-Prong Female Twist-Lock Plug	3-Prong Male Twist-Lock Plug	3-Prong Female Twist-Lock Plug	Length	
	1015543	16	2	1015551	1015552	—	—	25 Feet
	1015542	16	2	1015551	1015552	—	—	50 Feet
	1015546	16	2	—	—	1015555	1015556	25 Feet
	1015545	16	2	—	—	1015555	1015556	50 Feet
	1015547	16	2	—	—	1015555	1015556	100 Feet
	1015748	16	3	—	—	1015555	1015556	13 Feet
	1015745	16	3	—	—	1015555	1015556	50 Feet
	1015747	16	3	—	—	1015555	1015556	110 Feet

## OPTIONAL ACCESSORIES

		ELECTRIC CONTROL LINE PLUGS	
Part Numbers		Prong Style	Plug Style
	1015551	2-Prong Male	Twist-Lock
	1015552	2-Prong Female	Twist-Lock
	1015555	3-Prong Male	Twist-Lock
	1015556	3-Prong Female	Twist-Lock
	1015126	4-Pin Male	Low-Profile
	1015127	4-Pin Female	Low-Profile

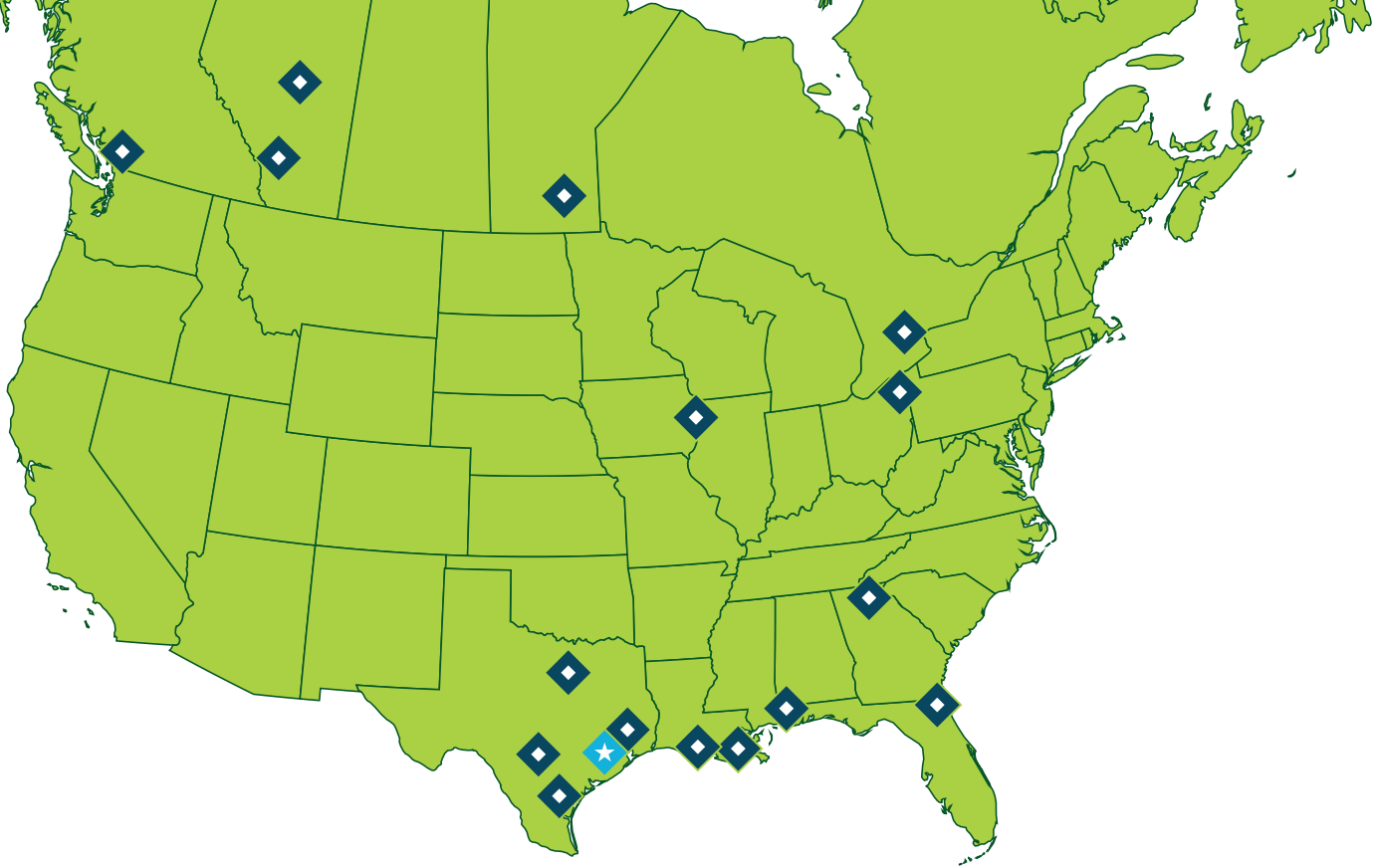

## ALLREDI THERE

Serving these industries: Bridge, Pipeline, Tank & Tower, Concrete Services, Rail, Shipyard & Marine, Pools & Fountains and Foundry

### UNITED STATES

#### **Pasadena, TX (Headquarters)**

844.361.7038

#### **Beaumont, TX**

409.722.1284

#### **Bristol, PA**

215.826.8080

#### **Corpus Christi, TX**

361.887.2038

#### **Davenport, IA**

563.324.2519

#### **Deer Park, TX**

*(Service & Rental Location)*

281.930.0905

#### **Duluth, GA**

800.535.4564

#### **Gonzales, LA**

225.647.7575

#### **Harvey, LA**

504.367.8090

#### **Houma, LA**

985.580.4273

#### **Jacksonville, FL**

904.262.2120

#### **Lafayette, LA**

337.267.1440

#### **Theodore, AL**

251.338.7525

#### **Youngstown, OH**

330.448.6267

### CANADA

#### **Calgary, Alberta**

403.279.1924

#### **Coquitlam, BC**

604.464.6979

#### **Edmonton, Alberta**

780.468.2588 (Manus)

780.425.5510 (Mod-U-Blast)

#### **Hamilton, Ontario**

905.527.6000 / 888.794.5665

#### **Mississauga, Ontario**

905.890.5837

#### **Winnipeg, Manitoba**

204.256.3324

**800-252-7848 / WWW.ALLREDI-US.COM**

Allredi™ and Marco® are registered trademarks of Allredi, LLC.

All other brand names or marks are used for identification purposes and are trademarks of their respective owners.

**ALLREDI™**

Literature #106M446\_8/23/22