



DUSTLESS BLASTING® DB225® MOBILE XS



PART NUMBERS AND SCHEMATICS GUIDE

Company Profile

Allredi was formed in the early 2020, when two of the largest distributors in the blasting, coating, safety, and environmental industry, APE Companies and Marco Group International, joined forces. While the qualities both companies are known for have not changed, a lot about our business is new. New abilities. New agilities. New ways to help you win. This calls for a new name, Allredi.

This name exemplifies what we have become. It is completely oriented to the needs of our customers. To your needs. It says that when you call us for anything – products, service, expert advice, anything – you can consider it done. Or even better, Allredi done.

We are your right-now supplier. From skills to SKUs, we deliver the goods fast. So you can be more agile every minute, every day. This is who we are. This is what our new name means. Go ahead and expect excellence, because we're bringing it.

Our Mission and Vision

To be the industry's preferred partner in surface preparation solutions through unrivaled technical expertise, customer experience, product availability, and tailored service offerings.

The Allredi Difference

- **Industry Experience** – With Allredi on your team, you have access to expertise which can only come from decades of industry leadership. We have organized our engineering department, production specialists, customer operations, and safety support into a "Center of Competence." As an Allredi customer, you have access to hundreds of years of cumulative experience related to your operations.
- **Manufacturing Excellence** – Allredi is a U.S. based manufacturer of equipment for the Surface Preparation and Protective Coatings industries. Allredi's engineers benchmark the industry to ensure that we design and manufacture superior products that set the "Gold Standard" for performance, safety, and quality.
- **Legendary Customer Service** – Allredi's legendary customer service team is staffed by friendly, highly-trained individuals who are focused on providing the highest level of product support, order accuracy, and customer satisfaction.
- **Product Availability** – We stock over 10,000 SKU's and have over 45 shipping locations to serve North American and International markets for all major brands of blasting, coating, environmental, and safety equipment. Allredi is your right-now supplier, so you can keep your projects moving. From our foundation of strong relationships, we have built a nationwide network that puts vast inventory and ready service close to our customers. We provide advanced expertise, and we deliver the goods fast – so you can easily access the products and services you need to me more agile every minute, every day.
- **Technology Leadership** – Our website provides: Operator's Manuals, Part Numbers and Schematics Guides, SDS information, and key product features and specifications, providing access to information 24/7.

TABLE OF CONTENTS

Company Profile	1
Table of Contents	2
Dustless Blasting® DB225®	
Mobile XS	3-16
Part Numbers & Specifications	3
Part Numbers & Schematics	5
DB225 Blast Pot	5-6
DB225 Mobile XS Trailer	7-8
Optional Accessories	9-11
Rotair/Elgi 185 CFM Compressor Kits	9
Blast Nozzles	9
Electric Control Line	10
Electric Control Line Plugs	10
Blast Hose	11
Couplings & Nozzle Holders	11
Maintenance Notes	12

PART NUMBERS

Part Numbers	DUSTLESS BLASTING® DB225® MOBILE XS				
	Blast Pot	Compressor	Water Tank	Water Pump	Abrasive Funnel
10111106	2.0 Cu Ft	100 CFM	35 Gal	Mini XS Air Dryer	X

Blast Pot Specifications: ASME / PED / CE Compliant

Operating Pressure: 30 - 150 PSI

Air Compressor: 24.3 Hp Engine
6.5 gal Diesel Tank

Trailer Specifications: DOT Compliant LED Lights
One 3500 lb torsion axle
8 Ply Tires

Trailer Dimensions: Weight: 2,221 pounds (est. loaded)
Length: 13' 6"
Width: 2' 6"

PART NUMBERS & SCHEMATICS



PART NUMBERS & SCHEMATICS GUIDE

Figure 1: DB225 Blast Pot

Item #	Part #	Description
Fig. 1		
—	10111106	DB225 Mobile Blasting System <i>Includes: Four Pinch Hoses with one set of couplers, Marco 151E Remote Control Switch, 50' Power Cord, 2' Adapter Cord</i>
1	10DBAMF0458	Fill Funnel
2	10DBAPG0104	1/4" Air Filter Regulator for Control Box
3	10DBAMF0297	Electric Control Box Assembly
4	10DBAPG0096	300 PSi Pressure Gauge
5	10DBAPG0067	1-1/4" Threading Norgren Compressed Air Regulator
6	10DBAPG0148	Back Connection Pressure Gauge - 200 PSI
7	1011062	1-1/4" Full Port Ball Valve, Nickel-Plated Brass
8	10DBAPG0081	1-1/4" Check Valve
9	10ME1	3/4" M NPT 2-Lug Coupling
10	10DBFMF0151	Pinch Valve Plate
11	10DBAMF0461	2-Lug KF Hose Coupling, Pinch Hose Elbow Adapter
12	10BH0342BR	3/4" ID Blast Hose Section, Per Foot
13	10QBR1	2-Lug Blast Hose Coupling, Brass <i>(Two Required)</i>
14	10DBAMF0699	Pneumatic Turbine Vibrator
15	10DBAMF0266	Fill Cap Assembly
16	10DBAPG0164	Fill Cap Gasket
17	10DBAPG0009	Outlet Elbow Cap Gasket
18	10DBAPG0005	Outlet Elbow Insert Gasket
19	10DBAPG0163	Outlet Elbow Insert, M-23
20	10DBPMF0152	Outlet Pipe
21	10DBAPG0010	Air Inlet Jet Gasket
22	10DBPMF0141	DB225 Air Inlet Jet, 1/2" Diameter
23	10DBAPG0011	Air Inlet Body Lugs
27	10DBPMF0245	Outlet Elbow Assembly
28	10DBFMF1135	1-1/4" Air Inlet Adapter, Stainless Steel
	10DBAMF0091	1-1/4" 90 Degree Elbow for Inlet
29	10DBAHW0061	Air Inlet Body Lug Bolts
30	10DBAPG0026	1-1/4" Close Nipple, Stainless Steel
—	1015100	Marco 151E Remote Control Switch <i>(Add 1015555 Plug to Connect to Power Cord)</i>
—	1015555	3 Prong Male Twist Lock Plug
—	1015545	50' 16/2 Power Cord with 3-Prong Male and Female Twist Lock Plugs
—	10111095	2' 16/2 Power Cord with 3-Prong Female Twist Lock and Male Weather Pack Plug <i>(Connects 1015545 Power Cord to Control Box)</i>
—	10DBSWPPDB225	DB225 Wear Parts Package <i>Includes: 11,18,19,20,21,22, gaskets & washers</i>

PART NUMBERS & SCHEMATICS GUIDE

Figure 1: DB225 Blast Pot

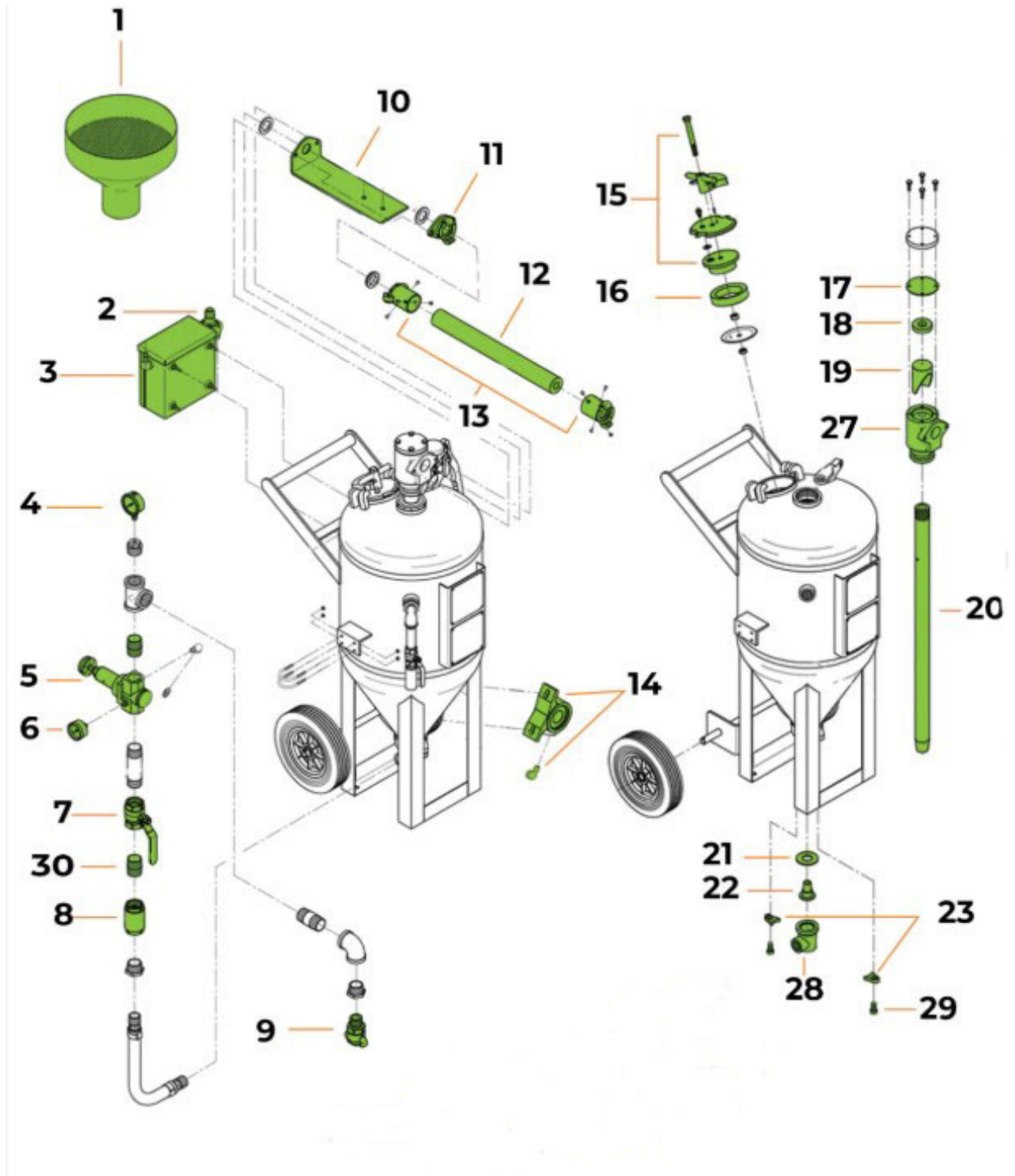

PART NUMBERS & SCHEMATICS GUIDE

Figure 2: DB225 Mobile XS Trailer

Item #	Part #	Description
Fig. 2		
1	10DBAMF0404	Trailer Jack Assembly
2	1011786	1/2-13 UNC x 2-1/4" Hex Bolt, Galvanized <i>(Four Required)</i>
3	10100675	1/2" Lock Washer, Galvanized <i>(Four Required)</i>
4	10100674	1/2" Flat Washer, Galvanized <i>(Four Required)</i>
5	10101941	1/2-13 UNC Nut <i>(Four Required)</i>
6	10DBAPG0199	Water Pump
	10DBSPG0023	Water Pump Rebuild Kit
7	10DBAPG0859	35 Gallon Water Tank
8	10DBAPG0860	Water Tank Bracket <i>(Two Required)</i>
9	20101171	3/8-16 UNC x 1-1/2" Bolt, Zinc <i>(Four Required)</i>
10	10101942	3/8" Galvanized Flat Washer <i>(Four Required)</i>
11	1012318	3/8-16 UNC Nut, Zinc <i>(Four Required)</i>
12	10DBAPG1074	ST205/75R15 Tire with 4.5 on 5 lug pattern <i>(Two Required)</i>
13	10DBAMF0875	1-1/4" x 18" LG Compressor to Radiator Hose Assembly
14	10DBAMF0808	Mini Air Dryer Radiator
	10DBAMF0801	Mini MT Separator
15	10DBAMF0879	1-1/4" x 8" LG MT to Blast Pot Hose Assembly
16	10DBAMF0174	Pinch Valve Hose
17	10DBAMF0701	Pinch Valve Assembly
18	10DBPMF0167	Safety Cover Top
19	10DBPMF0168	Safety Cover Bottom
—	10DBAMF0880	1-1/4" x 12" LG Radiator to MT Hose Assembly

PART NUMBERS & SCHEMATICS GUIDE

Figure 2: DB225 Mobile XS Trailer

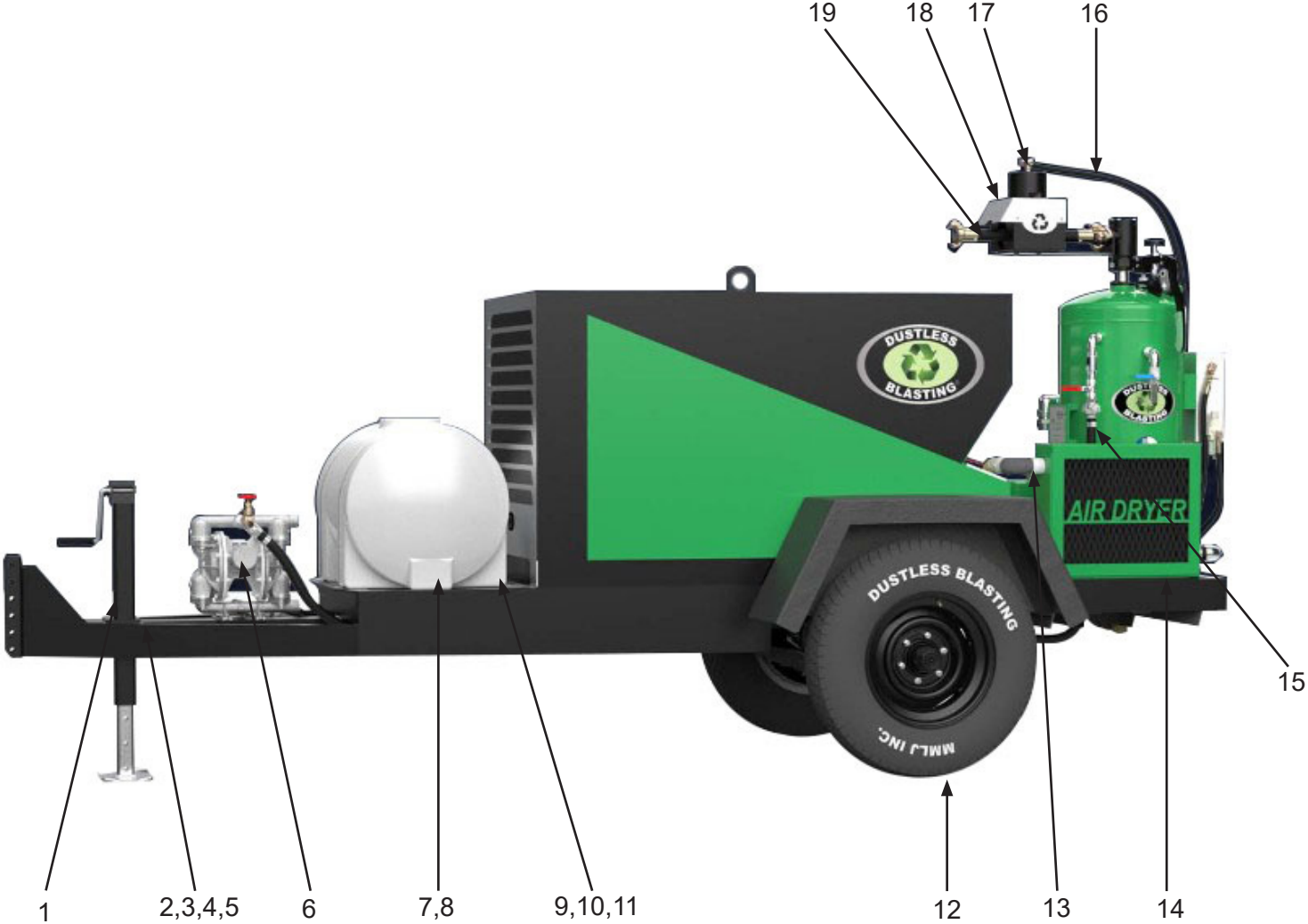

OPTIONAL ACCESSORIES



Air Compressor Maintenance Parts

Item #	Part #	Description
1	10DBXMAS05081	Air Filter
2	10DBXM2AS02317	Separator Element
3	10DBXM2AS02309	Oil Filter
—	<i>To Come</i>	First 50 Hour Maintenance Kit <i>Includes: Oil Filter, Fuel Filter, Engine Oil Filter & Washers</i>
—	<i>To Come</i>	500 Hour Maintenance Kit <i>Includes: Oil Filters, Fuel Filter, Inner and Outer Air Filters</i>



Part Numbers	#4 BLAST NOZZLES, 1-1/4" THREADS						
	Description	Nozzle Entry	Thread Size	Overall Length	Jacket Material	Thread Material	Liner Material
10SN4UN	Silicon Carbide All Poly	1"	1-1/4"	5-1/2"	Polyurethane	Polyurethane	Silicon Carbide
10TC4BP	Brass Poly	1"	1-1/4"	5-1/4"	Polyurethane	Brass	Tungsten Carbide
10TC4AU	Tungsten Carbide Aluminum Poly	1"	1-1/4"	5-1/4"	Polyurethane	Aluminum Alloy	Tungsten Carbide
10TC4UN	Tungsten Carbide All Poly	1"	1-1/4"	5-1/4"	Polyurethane	Polyurethane	Tungsten Carbide
10BDSH4AP	Blast Ninja	1-1/4"	1-1/4"	7.8"	Polyurethane	Polyurethane	Tungsten Carbide
10BDSN1594XL12	XL Nozzle	1-1/4"	1-1/4"	12"	Aluminum	Aluminum	Sialon

OPTIONAL ACCESSORIES

ELECTRIC CONTROL LINE WITH PLUGS

	Part Numbers	Gauge	# of Wires	Male Weather Pack Plug	3-Prong Male Twist-Lock Plug	3-Prong Female Twist-Lock Plug	Length
<i>No Image Available</i>	10111095	16	2	X	—	1015556	2 Feet
	1015748	16	3	—	1015555	1015556	13 Feet
	1015745	16	3	—	1015555	1015556	50 Feet
	1015747	16	3	—	1015555	1015556	110 Feet

ELECTRIC CONTROL LINE PLUGS

	Part Numbers	Prong Style	Plug Style
	1015555	3-Prong Male	Twist-Lock
	1015556	3-Prong Female	Twist-Lock
<i>No Image Available</i>	10111105	Weather Pack Plug Male & Female Plug and Connectors	Weather Pack

OPTIONAL ACCESSORIES

BLAST HOSE					
Part Numbers	Hose ID	Hose OD	4-Ply Fabric Reinforcement	Length (feet)	Working Pressure
10BH0342BR	3/4"	1-1/2"	X	Per Foot	150 PSI
10BH034B	3/4"	1-1/2"	X	50'	150 PSI
10BH0344B	3/4"	1-1/2"	X	100'	150 PSI

BLAST HOSE COUPLINGS & NOZZLE HOLDERS					
Part Numbers	Hose ID x OD	Coupling Type	Coupling Material	Thread Type	Gasket Type
10QBR1	3/4" ID x 1-1/2" OD	2-Lug Coupling	Brass	2-Lug	10SBG/10USBG
10NHB1	3/4" ID x 1-1/2" OD	Nozzle Holder	Brass	1-1/4" Threads	10NW



ALLREDI THERE

Serving these industries: Bridge, Pipeline, Tank & Tower, Concrete Services, Rail, Shipyard & Marine, Pools & Fountains, and Foundry

UNITED STATES

Pasadena, TX (*Headquarters*)
281.930.0808

Beaumont, TX
409.722.1284

Bristol, PA
215.826.8080

Corpus Christi, TX
361.887.2038

Davenport, IA
563.324.2519

Deer Park, TX
(*Service & Rental Location*)
281.930.0905

Duluth, GA
770.938.7263

Gonzales, LA
225.647.7575

Harvey, LA
504.367.8090

Houma, LA
985.580.4273

Lafayette, LA
337.267.1440

Theodore, AL
251.338.7525

CANADA

Calgary, Alberta
403.279.1924

Coquitlam, BC
604.464.6979

Edmonton, Alberta
780.468.2588 (Manus)
780.425.5510 (Mod-U-Blast)

Hamilton, Ontario
905.527.6000 / 888.794.5665

Mississauga, Ontario
905.890.5837

Winnipeg, Manitoba
204.256.3324

WWW.ALLREDI.COM / 800.252.7848

WWW.ALLREDI-CA.COM / 800.661.3842

Allredi™ and Marco® are registered trademarks of Allredi, LLC.
Mod-U-Blast® is a registered trademark of Allredi Blast & Abrasives Canada, Inc.
All other brand names or marks are used for identification purposes and are trademarks of their respective owners.

ALLREDI™

Literature #106M655_1/27/2026